

2026

Fabrication & Maintenance Tools

Tube Tool Crib

Elliott Tool Technologies

STRATEGIES

FOR SUCCESSFUL HEAT
EXCHANGER TUBE
PLUGGING

PAGE 168

AVOIDING

COMMON PITFALLS OF
TUBE EXTRACTION

PAGE 186

UNDERSTAND
TUBE FAILURE
MECHANISMS

PAGE 160

ELLIOTT'S NEW TUBE END MILL

**PERFORMANCE &
DURABILITY FINALLY
TOGETHER**

PAGE 196

A HISTORY OF INNOVATION

1892 – Present

130 YEARS OF EXPERIENCE

Why Choose Elliott Tool?

In September 1892, an inventor and manufacturer named Gustav Wiedeke began a small manufacturing business in a modest building at the rear of his Dayton, Ohio home. Today, over 100 years later, Wiedeke Dayton has become Elliott Tool Technologies Ltd. due to Mr. Wiedeke's efforts.

The Wiedeke business continued to operate as a family enterprise for the next 32 years. By this time, Wiedeke products had earned a worldwide reputation for excellence in the industries they served. Wiedeke tools were innovative enough to be covered by various patents and trademarks.

In 1916, William Elliott also recognized the need and opportunity in the industry for efficient tube cleaning equipment. Operating plants in both Ohio and Pennsylvania, the company went through several company name iterations (Lagonda Springfield and Elliott Springfield) and eventually became known as the Elliott Company. By the late 1960's, Elliott Company also enjoyed a worldwide reputation for its cleaning and turbo-machinery products. And in 1969, acquired the Gustav Wiedeke Company.

Today we are a private company known as Elliott Tool Technologies. Boasting self directed work teams, exceptional customer service, and a continued commitment to produce tube tools Gustav Wiedeke and William Swan Elliott would be proud of.

Elliott Tool Technologies is proud to represent more than 130 years of manufacturing, sales, and engineering experience.

1892

Gustav Wiedeke begins a small manufacturing business in Dayton, OH.



1969

Elliott Company acquires the Gustav Wiedeke Company.



1916

William Elliott founds Elliott Company and starts selling tube cleaning equipment.



2026

Now known as Elliott Tool Technologies, we are proud to represent 125 years of manufacturing, sales and engineering excellence.

FEATURED ARTICLES

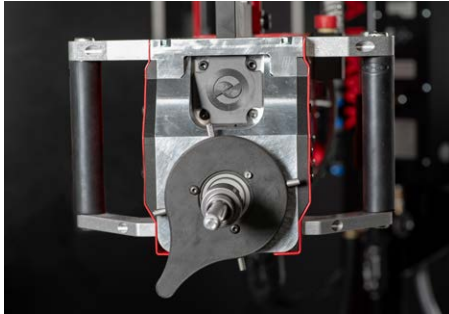

**Parallel vs. Tapered Roll:
Impact on Stress Corrosion**
Page 22



**3 Ways Operator Training
Benefits Your Organization**
Page 100



**Strategies for Successful Heat
Exchanger Tube Plugging**
Page 168

ARTICLES

Parallel vs. Tapered Roll Expansion 22

Expanding Thicker Tube Sheets in Heat Exchangers 40

How to Select the Right Assisted Rolling System..... 62

The Critical Role of Torque in Tube Expansion..... 70

How Operator Training Benefits Your Organization..... 100

Guide to Cleaning Unknown Deposits 106

Challenges of Marine Chiller & Heat Exchanger
Maintenance 116

Understanding Tube Failure Mechanisms 160

Successful Heat Exchanger Tube Plugging 168

Steps, Types & Importance: Heat Exchanger Plugs..... 181

Guide to Installing Mechanical Tube Plugs 182

Avoiding Common Pitfalls of Tube Extraction 186

Benefits of a Tube Bundle Cutter 210

RESULTS REPORTS

Alfa Laval Ace Reduces Expansion Cycle Times by 50%
With Elliott's Rapid Hawk 08

Keller & Associates Inc. Find the Best Bead
in the Market 34

U.S. Fabricator Cut Costs & Boosts Quality With 24
Series Expander 54

Dunn Heat Exchanger Reduces Expansion Cycle Times
by 80% 90

University of Texas at Austin Chooses the Die Hard as
their Preferred Cleaning Machine 122

Recycling Plant Finds a Superior & Productive Way to
Clean Boiler Tubes 126

Fabrication Shop Reports 10X More Life With E-Series
Hex Spears 192

CONTACT US

North / Central / South America

Phone: +1 (937) 253 6133
 Toll-Free: +1 (800) 332 0447
 Fax: +1 (937) 253 9189
 Address: 1760 Tuttle Avenue Dayton,
 OH 45403 United States

Email: sales@elliott-tool.com
 Web: www.elliott-tool.com

Europe, Middle East, Asia

Phone: +44 (0) 1643 709037
 Fax: +1 (937) 253 9189
 Address: United Kingdom

For Terms and Conditions, visit our website:
www.elliott-tool.com/terms

United States Gulf Coast

Phone: +1 (409) 995 0803
 Email: gulfcoastsales@elliott-tool.com
 Address: 2814 25th Ave North Texas City,
 TX 77590 United States

CONTENTS

— INSTALL

| | |
|--|-----|
| Tube Hole Gauge..... | 10 |
| Tube Sheet Hole Brushes..... | 12 |
| GT Series Grooving (Serrating) Tools | 13 |
| Pneumatic Hammer | 15 |
| ETF Series Tube End Facers | 16 |
| ETF Series Drive Motors..... | 17 |
| Tube Pilots/Guides | 18 |
| Lubricants..... | 19 |
| 900 Series Flaring Boiler Expanders | 20 |
| 1500 Series Flaring Boiler Expanders | 24 |
| 3400 Series Flaring Boiler Expanders | 26 |
| 3300 Series Straight Boiler Expanders..... | 28 |
| DRE Series Deep Roll Boiler Expanders | 30 |
| 40 Series Straight Boiler Expanders..... | 32 |
| 4480 Series Single Roll Beading Expanders | 36 |
| 23 Series Condenser Expanders..... | 38 |
| 24 Series Condenser Expanders..... | 42 |
| 6621 Series Sugar Mill Vacuum Pan Expander | 56 |
| 3321 Series Sugar Mill Vacuum Pan Expander | 57 |
| Collet Style Support Sheet Expanders..... | 58 |
| Tube Expander Accessories..... | 59 |
| 99 Series Electric Rolling Motors | 60 |
| ELC110220 Electric Torque Controller | 64 |
| ET Series Torque Controlled Pneumatic Rolling Motors | 66 |
| Midi/Maxi Series Torque Controlled Pneumatic Rolling Motors | 69 |
| 445 Series Right Angle Pneumatic Motors | 74 |
| Stall Torque Pneumatic Rolling Motors | 76 |
| Rolling Motor Accessories | 77 |
| Table Hawk | 80 |
| Rapid Hawk..... | 84 |
| Ultra Hawk Assisted Tube Rolling System | 92 |
| Monster Hawk Assisted Tube Rolling Systems..... | 102 |
| PX24 Series Parallel Pin Expanders..... | 103 |

— CLEAN

| | |
|---|-----|
| Jumbo Jiffy Gun | 108 |
| 5224XL & 5125 Series | 110 |
| Roto-Jet | 114 |
| Die-Hard..... | 120 |
| Soot Buster | 124 |
| Turbine Style Straight Tube Cleaners | 128 |
| Turbine Style Curved Tube Cleaners | 135 |
| Turbine Style Tube Cleaner Accessories | 145 |
| Vent Hole Cleaner..... | 146 |
| Operating Hoses | 147 |
| Turbine Style Aluminum Siphon Tube Cleaners | 148 |
| Gas Line Renewal..... | 149 |
| Pipe Rattling Equipment..... | 150 |
| ET Series Oil Field Pipeyard Cleaning Heads & Motors | 151 |

— TEST

| | |
|---|-----|
| RECON Series Pressure Tube Leak Test Guns | 156 |
| RECON Series Vacuum Tube Leak Test Guns | 162 |

— PLUG

| | |
|-----------------------------|-----|
| One-Piece Tube Plugs..... | 166 |
| Two-Piece Tube Plugs..... | 170 |
| Mechanical Tube Plugs | 174 |
| Header Plugs..... | 180 |



— REMOVE

| | |
|------------------------------------|-----|
| One-Revolution Tube Cutter..... | 188 |
| PTTC Series Tube Cutter..... | 190 |
| 300 Series Boiler Tube Cutter..... | 194 |
| Tube End Mill..... | 196 |
| SpeedCut..... | 198 |
| Hydraulic Pumps..... | 202 |
| Collet Tube Puller..... | 203 |
| Super Collet Tube Puller..... | 204 |
| Cyclgrip..... | 207 |
| Tube Tugger..... | 208 |
| Super Tube Tugger..... | 209 |
| Tapping Spears..... | 212 |
| TT Tube Spears..... | 214 |
| Stub Tugger..... | 216 |
| Manual Tube Puller..... | 218 |
| E-Series Hex Spears..... | 219 |
| 430G Series Pneumatic Hammer..... | 221 |
| 430G Series Accessories..... | 222 |
| Wall-Reducing Tools..... | 223 |
| 430D Series Jumbo Tube Buster..... | 224 |
| Knockout Tools..... | 225 |

Helpful application guides, manuals, and other information that will help you get your job done more efficiently are offered for free. In addition we offer local support in more than 30 countries around the world.

To access information, visit our web site:
www.elliott-tool.com



*Quality products
 manufactured in the USA.*



Many of our products are available for rent. Please see page 230 for more information on Elliott's rental program.

— SUPPORT

| | |
|---------------------------------|-----|
| Quality Assurance..... | 228 |
| "I Need It Yesterday"..... | 229 |
| Rental Capability..... | 230 |
| Tube Wall Conversion Table..... | 232 |
| Recommended Cutting Speeds..... | 233 |

INSTALL



CONTENTS

| | |
|--|-----|
| Tube Hole Gauge..... | 10 |
| Tube Sheet Hole Brushes..... | 12 |
| GT Series Grooving (Serrating) Tools..... | 13 |
| Pneumatic Hammer..... | 15 |
| ETF Series Tube End Facers..... | 16 |
| ETF Series Drive Motors..... | 17 |
| Tube Pilots/Guides..... | 18 |
| Lubricants..... | 19 |
| 900 Series Flaring Boiler Expanders..... | 20 |
| 1500 Series Flaring Boiler Expanders..... | 24 |
| 3400 Series Flaring Boiler Expanders..... | 26 |
| 3300 Series Straight Boiler Expanders..... | 28 |
| DRE Series Deep Roll Boiler Expanders..... | 30 |
| 40 Series Straight Boiler Expanders..... | 32 |
| 4480 Series Single Roll Beading Expanders..... | 36 |
| 23 Series Condenser Expanders..... | 38 |
| 24 Series Condenser Expanders..... | 42 |
| 6621 Series Sugar Mill Vacuum Pan Expander..... | 56 |
| 3321 Series Sugar Mill Vacuum Pan Expander..... | 57 |
| Collet Style Support Sheet Expanders..... | 58 |
| Tube Expander Accessories..... | 59 |
| 99 Series Electric Rolling Motors..... | 60 |
| ELC110220 Electric Torque Controller..... | 62 |
| ET Series Torque Controlled Pneumatic Rolling Motors..... | 64 |
| Midi/Maxi Series Torque Controlled Pneumatic Rolling Motors..... | 67 |
| 445 Series Right Angle Pneumatic Motors..... | 72 |
| Stall Torque Pneumatic Rolling Motors..... | 73 |
| Rolling Motor Accessories..... | 74 |
| Table Hawk..... | 78 |
| Rapid Hawk..... | 81 |
| 24 Series Auto-Lubrication Expanders..... | 85 |
| Ultra Hawk Assisted Tube Rolling System..... | 90 |
| Monster Hawk Assisted Tube Rolling Systems..... | 100 |
| PX24 Series Parallel Pin Expanders..... | 101 |

REDUCES EXPANSION CYCLE TIMES BY 50%



QUICK SUMMARY

The Challenge

- Current tube rolling system was primarily by feel and did not provide the expansion consistency they wanted.
- Too much time spent re-rolling to pass hydro.
- Stopping periodically to lubricate their expanders was time consuming.

The Solution

- Elliott's Hybrid Series Rapid Hawk with pneumatic motor and Direct Torque™ electronic torque control.
- Production trials to determine joint consistency, ease of operator use, and rolling times.

The Results

- Time savings of 50% per tube and a cost savings of ~\$60,000 annually.
- Virtually zero tube leaks, reducing the number of man-hours attributed to re-rolling.
- Provided $\pm 2\%$ variance from the target wall reduction.
- Significant time-savings from the through-the-cage auto-lubrication feature.
- Increased ergonomics reduced operator fatigue and strain.
- Increased tool life.

The Challenge

Alfa Laval ACE, located in Broken Arrow, OK, specializes in heat transfer, separation, and fluid handling technology. With a focus on producing quality air coolers for their customers, rolling consistency was of utmost importance. With their current tube rolling method relying heavily on operator feel to regulate the amount of wall reduction, the accuracy of wall reduction was lower than desired. This resulted in too much time spent re-rolling tubes.

In addition to consistency, Alfa Laval was also looking for a method that would reduce the number of man-hours spent on a project. Due to their current tube rolling method, operators not only needed to regulate the amount of expansion taking place, they also had to stop periodically to re-lubricate the tooling. Operators would spend up to 1,350 hours annually lubricating tooling alone. Not to mention, this process was extremely messy and resulted in extra time spent cleaning up excess lubricant. Overall, this heavy reliance on operator care increased the amount of time and cost spent on a project.

The Solution

With roll consistency being of top priority, the Alfa Laval Team was eager to find an alternative tube rolling method. After numerous conversations with Elliott representatives, the Alfa Laval Team decided that the Hybrid Series Rapid Hawk could be the most comprehensive solution.

Elliott's Hybrid Series Rapid Hawk utilizes a pneumatic motor to provide fast cycle times for each expansion. While pneumatic motors are faster than electric, they tend to have challenges with consistency due to fluctuations in air volume or pressure. The

Hybrid Series is able to help Alfa Laval achieve their goal of more consistency and less rework by utilizing Direct Torque™, an electronic torque control built into the Hybrid Series that can work with any motor regardless of its power source. Additionally, the Auto-Lubrication feature would greatly reduce the amount of downtime between tube expansions by providing lubricant through the cage directly to the rolls and mandrel during each expansion. Operators would also appreciate the Auto-Cycle feature, as it would reduce the amount of time and manual force required to insert and retract the expander from the tubes.

After receiving the Hybrid Series Rapid Hawk, Alfa Laval conducted several trials to determine wall reduction consistency, ease of operator use, and overall rolling cycle time.

The Results

The Hybrid Series Rapid Hawk produced positive results almost immediately. With roll consistency showing a significant improvement, Alfa Laval was pleased with the accuracy of the system. “We aim for an 8% reduction and the Hybrid Series gets us to that range so well,” said Ryan Pitre, Manufacturing Engineer. “The quality and roll consistency is so much better. It takes into account all variables and executes precisely.” The Hybrid Series rolled tubes within 2% of their target wall reduction every time, whereas their pre-

vious tube rolling method had as much as 6% variation. This increase in consistency significantly reduced the number of man-hours attributed to re-rolling tubes, with virtually zero leaking joints at hydro testing.

The Hybrid Series was also able to reduce the tube-to-tube expansion cycle time and the overall cost to complete a project. “The Auto-Lube system has been huge, with a time savings of 50% per tube and a cost savings of ~\$60,000 annually,” Ryan said. Not only did the auto-lubrication system save man hours from lubricating tooling, it also significantly reduced the time spent cleaning up excess lubricant. The Direct Torque™ control not only increased accuracy, but it also benefited operators. The guesswork that was necessary with their previous tube rolling system was eliminated, allowing them to complete their job faster. Additionally, the Auto-Cycle reduced the amount of time spent between expansions by starting, stopping, and reversing automatically. It also reduced the amount of manual force required to complete a job: “It [Auto-Cycle] makes it so easy to use. It draws itself into the tube and pushes itself out, so virtually no operator force is needed,” Ryan said.

With the significant increase in accuracy and consistency, the Rapid Hawk Hybrid Series was able to help operators increase productivity. Overall, the Alfa Laval Team was extremely pleased with both the performance of the system and the support

gained from the Elliott team. “Support was the reason we went with the Elliott equipment,” Ryan explained, “The product is great and the people we worked with have been great.”

“

We aim for an 8% reduction and the Hybrid Series gets us to that range so well. The quality and roll consistency is so much better. It takes into account all variables and executes precisely.

Ryan Pitre
Manufacturing Engineer

SAVE ~ \$60,000 ANNUALLY THROUGH THE CAGE AUTO-LUBRICATION

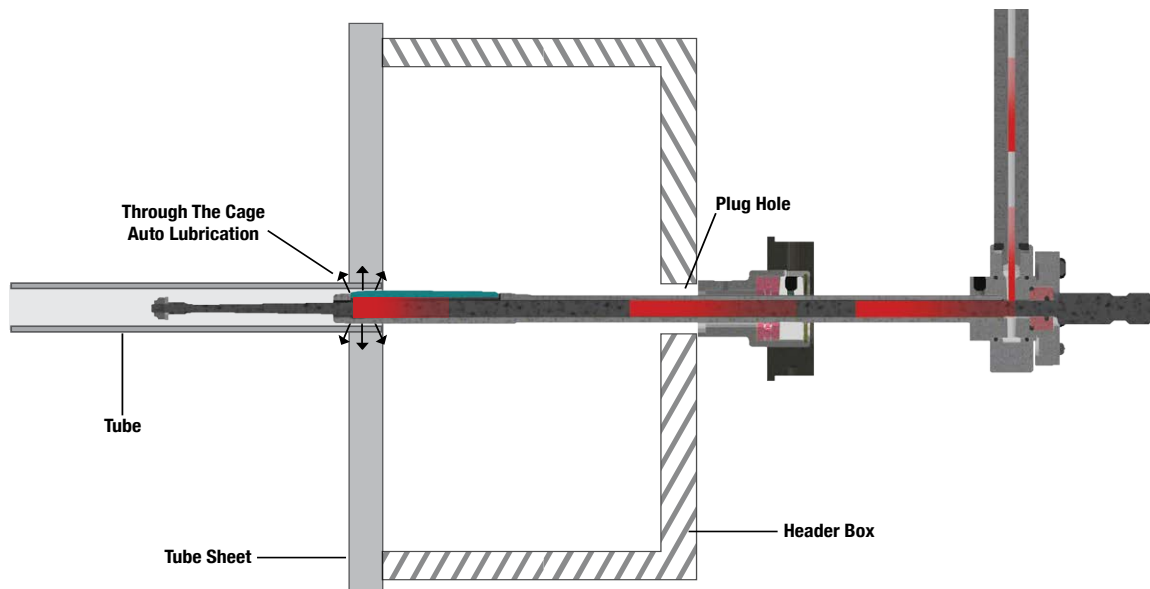

TUBE HOLE GAUGE

Hole Size

- 0.375" to 2.000" OD
- (9.5 to 51.0mm) OD

Elliott's Tube Hole Gauges make it easy to accurately measure tube IDs and tube sheet holes found in vessels such as heat exchangers, chillers, and surface condensers.

Simply insert the tube gauge in the tube or tube sheet hole and use the three point ball contact to obtain an accurate measurement. Elliott's Reversible Dial Plate offers metric on one side and inch/decimal on the other to suit your needs.

The standard measurement depth is 4" (101.6mm) or 8" (203.2mm) (see the table to the right) with additional extensions of 8" (203.2mm) available. See the Spares & Accessories section for more information on these extensions.



Features & Benefits:

- 3 point contact much more accurate than common 2 point calipers.
- Can measure inside the tube where the actual rolling area will occur.
- More economical and rugged than electronic gauges.
- Easy to calibrate in field so accuracy is maintained.
- Large, reversible dial face for easily measuring in inches and metric.

Spares & Accessories:

- Mandrel Extension: Will add 8" (203.2mm) to maximum reach. One Body Extension is required for each Mandrel Extension.
- Body Extension: Will add 8" (203.2mm) to maximum reach. One Mandrel Extension is required for each Body Extension.
- Mandrel
- Body
- Setting Ring

Tube Hole Gauge includes:

- Tube Hole Gauge
- Setting Ring
- Wrench
- Storage Box



TUBE HOLE GAUGE

TUBE HOLE GAUGE

| Tube OD | ID Range | | Tube Hole Gauge | Reach | Setting Ring | Mandrel Extension* | Body Extension* |
|---------------------------|--------------------|--------------------|-----------------|-------|--------------|--------------------|-----------------|
| | Min | Max | | | | | |
| 3/8" (9.5mm) | 0.290" (7.4mm) | 0.350" (8.9mm) | 876200-375 | 4" | 8252-3/8 | 876210-500 | 876211-375 |
| 1/2" (12.0mm) | 0.350" (8.9mm) | 0.450" (11.4mm) | 876200-500 | 4" | 8252-1/2 | | 876211-500 |
| 5/8" (15.9mm) | 0.440" (11.0mm) | 0.560" (14.2mm) | 876200-625 | 4" | 8252-5/8 | | 876211-625 |
| 3/4" (19.1mm) | 0.550" (14.0mm) | 0.715" (18.2mm) | 876200-750 | 8" | 8252-3/4 | | 876211-750 |
| 7/8" (22.2mm) | 0.675" (17.1mm) | 0.840" (21.3mm) | 876200-875 | 8" | 8252-7/8 | | |
| 1" (25.4mm) | 0.800" (20.3mm) | 0.965" (24.5mm) | 876200-1000 | 8" | 8252-1 | | |
| 1-1/4" (31.8mm) | 0.950" (24.1mm) | 1.170" (29.7mm) | 876200-1250 | 8" | 8252-1-1/4 | | |
| 1-3/8" (35.0mm) | 1.085" (27.5mm) | 1.295" (32.9mm) | 876200-1375 | 8" | 8252-1-3/8 | | |
| 1-1/2" (38.1mm) | 1.240" (31.5mm) | 1.450" (36.8mm) | 876200-1500 | 8" | 8252-1-1/2 | 876210-1500 | 876211-1500 |
| 1-3/4" (44.5mm) | 1.440" (36.6mm) | 1.650" (41.9mm) | 876200-1750 | 8" | 8252-1-3/4 | 876210-2000 | 876211-1750 |
| 1-7/8" (47.6mm) | 1.630" (41.4mm) | 1.840" (46.7mm) | 876200-1875 | 8" | 8252-1-7/8 | | 876211-2000 |
| 2" (50.8mm) | 1.700" (43.2mm) | 1.910" (48.5mm) | 876200-2000 | 8" | 8252-2 | | |

*Note: Extensions will add 8 inches of reach. Multiple extensions may be used to achieve a longer reach.

**No more than 3 extensions should be used. If more than 3 extensions are needed, please contact sales@elliott-tool.com



TUBE SHEET HOLE BRUSHES

Hole Size

- 0.250" to 1.250" OD
- (6.4 to 31.8mm) OD



Elliott's Tube Sheet Hole Brushes clean and remove hard deposits from tube sheets and support plate holes in surface condensers and heat exchangers.

These brushes are constructed of high carbon steel with a double twisted stem to provide for maximum life and durability.

Features & Benefits:

- High carbon steel bristles for cleaning hard deposits.
- Brush stems are high carbon steel with a double twist for extra life. Brush stems could also be stainless steel.

| Size | | Brush |
|--------|------|----------|
| Inch | mm | |
| 1/4" | 6.0 | P5252-4 |
| 3/8" | 9.5 | P5252-6 |
| 1/2" | 12.7 | P5252-8 |
| 5/8" | 15.9 | P5252-10 |
| 3/4" | 19.1 | P5252-12 |
| 7/8" | 22.2 | P5252-14 |
| 1" | 25.4 | P5252-16 |
| 1-1/4" | 31.8 | P5252-20 |



Hole Size

- 0.375" to 3.000" OD
- (9.5 to 76.2mm) OD



CUTTING EDGE DESIGN & PERFORMANCE

Increase Mandrel Tool Life & Cutting Performance With Powerful Chip Escapement

Elliott's newly redesigned GT Series Grooving & Serrating Tools are engineered for optimal cutting performance and tool life. Now equipped with a chip escapement window, the new mandrel design allows for metal chips to escape easily, reducing damage to the mandrel and tube sheet hole.

Grooving (Serrating) Tools can be used manually to clean up existing grooves or in milling and drilling equipment for OEM tube sheet thicknesses of 3/8" (9.5mm) through 2-1/8" (54.0mm).

GT Series Grooving Tool includes:

- Cutter Bit (GT-31-3 configuration)
- Mandrel

Features & Benefits:

Improve Cutting Performance

Cutter bits are designed for extended tool life, allowing for repeatable, accurate cuts.

Extend Mandrel Tool Life

Chip escapement design reduces tool wear, reducing the need to replace the mandrel.

Designed For Optimal Metal Chip Escape

New mandrel design allows for optimal chip escape, reducing damage to the mandrel and tube sheet hole.

Suitable For A Variety Of Applications

Designed for use in both manual and machining applications, the GT Series allows for customer flexibility.

Spares & Accessories:

- Cutter Bit: Available in different configurations for cutting ferrous and stainless steel materials.
- Mandrel

Dimensions for ABC listed below

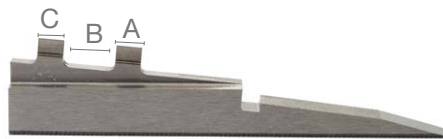

| Size | | Grooving Tool | Mandrel | Morse Taper* |
|-------|------|---------------|-----------|--------------|
| Inch | mm | | | |
| 3/8 | 9.5 | GT375* | GT375-03* | 3 |
| 1/2 | 12.7 | GT500* | GT500-03* | |
| 5/8 | 15.9 | GT625* | GT625-03* | |
| 3/4 | 19.1 | GT750 | GT750-03 | |
| 7/8 | 22.2 | GT875 | GT875-03 | |
| 1 | 25.4 | GT1000 | GT1000-03 | |
| 1-1/4 | 31.8 | GT1250 | GT1250-03 | |
| 1-1/2 | 38.1 | GT1500 | GT1500-03 | 4 |
| 1-3/4 | 44.5 | GT1750 | GT1750-03 | |
| 2 | 50.8 | GT2000 | GT2000-03 | |
| 2-1/2 | 63.5 | GT2500 | GT2500-03 | |
| 3 | 76.2 | GT3000 | GT3000-03 | |

*straight shank options available upon request

| Grooving Tool Blades | | | A | B | C |
|----------------------|------------|--------------|------|------|------|
| GT375 | GT500 | GT625-GT3000 | | | |
| GT375-31-1 | GT500-31-1 | GT100-31-1* | 1/8" | 1/8" | 1/8" |
| GT375-31-3 | GT500-31-3 | GT100-31-3* | 1/8" | 1/4" | 1/8" |
| GT375-31-4 | GT500-31-4 | GT100-31-4* | 1/8" | 3/8" | 1/8" |
| - | GT500-31-6 | GT100-31-6* | 1/8" | 1/2" | 1/8" |
| - | GT500-31-7 | GT100-31-7* | 1/8" | 5/8" | 1/8" |

Note: GT375-31 and GT500-31 blades work on ferrous and stainless steel materials.

* Add an "S" to the end when working on Stainless Steel tubes or tube sheets.

Contact Elliott for more blade configurations.



COMING 2026

Elliott's Tube End Mill

PRECISION CUTTING WITHOUT COMPROMISE.

Fast, precise tube end preparation built for demanding applications.

Elliott's all-new Tube End Mill delivers precise tube end trimming, seal and strength weld removal, and tube sheet hole beveling for 3/4" to 1-1/2" tube and pipe applications.

Engineered with a rugged locking and feed system, the Tube End Mill reduces premature tool breakage, minimizes downtime, and lowers cost per cut — even in the toughest materials.

See page 196 to see full specifications, accessories, and more.

Rugged Locking Mechanism

Durable design prevents premature tool breakage and wear, reducing downtime and cost.

Ease of Set-Up

Simply set in the tube or tube sheet hole, engage the locking system, and feed the cutting end forward.

Longer Life On Exotic Materials

Get better tool life on trimming exotic materials with AlCrN coated cutting inserts.

Consistent Trimming Every Time

The adjustable collar allows for consistent tube trimming every time, eliminating downtime from manual checks.

Faster Tooling Change-Outs

Quickly swap out holders, bits, and locking sizes with minimal screws and little to no disassembly.

Convenient Compatibility

Holders and cutting inserts are designed to be compatible with Kraiss® for convenient use of existing systems.

430G SERIES Pneumatic Hammer

Tube Size

- 0.250" to 2.000"+ OD
- (6.4 to 50.8mm) OD

Elliott's 430G Pneumatic Hammer is the recommended driving tool for Elliott's Beading Tools and Flaring Tools.

Beading Tools are made with different size radii for beading tubes in firetube boilers while Flaring Tools are used for flaring the inside of tube ends.

The 430G Pneumatic Hammer accepts Type No. 6 0.680" (17.3mm) diameter by 2-3/8" (60.3mm) long shanks.



Features & Benefits:

- Lightweight & compact design - easy to move in tight areas.
- Uses retainers on tools - improved operator safety.

Specifications:

- Piston Diameter & Stroke: 1-1/8" X 2" (28.6 X 50.8mm)
- Length (Overall): 14" (355.6mm)
- Blows per minute: 2,300
- Net Weight: 17 lbs. (7 Kg.)
- Air Requirement: 30 CFM @ 90 PSI
- Hose Diameter: 1/2" (12.7mm)

Elliott's Pneumatic Beading Tools, used with the 430G Pneumatic Hammer, are made with different size radii for beading tubes in firetube boilers.

The standard Type No. 1 shank is 0.680" (17.3mm) diameter by 2-3/8" (60.3mm) long.

Elliott's Flaring Tools, used with the 430G Pneumatic Hammer, are used for flaring the inside of tube ends.

The standard Type No. 6 shank is 0.680" (17.3mm) diameter by 2-3/8" (60.3mm) long with an oval collar.

430G Pneumatic Hammer package includes:

- Hose Whip
- Filter-Lubricator
- Carrying Case

Spares & Accessories:

- 6070 Filter-lubricator: Included with the 430G Pneumatic Hammer package.
- Flaring Tools.
- Beading Tools.

| Beading Tools | | | |
|----------------------|-----------------------|----------------|---|
| Radius For Pneumatic | For Tubes Bead Inches | BWG | Beading Tool |
| 75-456 | 9/64 (3.6mm) | 13 and Lighter |  |
| 75-456S | 3/16 (4.8mm) | 10, 11 and 12 | |
| 75-456A | 7/32 (5.6mm) | 8 and 9 | |

| Flaring Tools | | |
|----------------|----------|---|
| Tube Size | Part No. | Flaring Tool |
| 1/4" thru 3/8" | 8498D |  |
| 7/16" thru 1" | 8498 | |
| 1" thru 1-1/2" | 8498A | |
| 1-5/8" thru 2" | 8498B | |



ETF SERIES

Tube End Facers

Tube Size

- 0.375" to 1.500" OD
- (9.5 to 38.1mm) OD

Elliott's ETF Series Tube End Facers are ideal for trimming heat exchanger, condenser, and chiller tubes to a specific tube projection after tube expansion.

Each Tube End Facer is equipped with an adjustable collar to allow tubes to be faced flush or to a specified length from the tube sheet. Each Tube End Facer also incorporates a 3/8" (9.5mm) male hex.

The Tube End Facers use high alloy facer bits with two cutting edges that are specially coated for increased life. Elliott offers two bit styles, Non-Ferrous / Steel and Stainless Steel, to achieve optimum cutting efficiency.

Elliott's electric and pneumatic motors are excellent drivers for Tube End Facers. See next page for more information.

Features & Benefits:

- Economical & easy blade replacement.
- Standard pilot set included.
- Adjustable stand-off - 1/4" to flush.



Tube Facer Includes:

- Tube Facer
- Facer Pilots
- Hex Keys

Spares & Accessories:

- Non-Ferrous Steel Facer Bits
- Stainless Steel Facer Bits
- Cutting Oil: *See page 19 for part numbers.*
- Pilots

| Tube OD | | Std. Gauge Range | Tube ID | | *Tube Facer | Tool Bits | | Pilots |
|---------|--------|------------------|---------------|---------------|-------------|-------------------|-----------------|--------------|
| Inch | Metric | | Inch | Metric | | Non-Ferrous Steel | Stainless Steel | |
| 3/8 | 9.53 | 16-23 | 0.245 - 0.319 | 6.22 - 8.10 | ETF375 | ETF376 | ETF376SS | ETF375P(ga) |
| 1/2 | 12.70 | 16-23 | 0.370 - 0.444 | 9.40 - 11.28 | ETF500 | ETF506 | ETF506SS | ETF500P(ga) |
| 5/8 | 15.88 | 14-23 | 0.459 - 0.569 | 11.66 - 14.45 | ETF625 | ETF626 | ETF626SS | ETF625P(ga) |
| 3/4 | 19.05 | 10-23 | 0.482 - 0.694 | 12.24 - 17.63 | ETF750 | ETF756 | ETF756SS | ETF750P(ga) |
| 7/8 | 22.22 | 10-23 | 0.607 - 0.791 | 15.42 - 20.09 | ETF875 | ETF876 | ETF876SS | ETF875P(ga) |
| 1 | 25.40 | 10-23 | 0.782 - 0.916 | 19.86 - 23.27 | ETF1000 | ETF1006 | ETF1006SS | ETF1000P(ga) |
| 1-1/8 | 28.58 | 10-23 | 0.907 - 1.041 | 23.04 - 26.44 | ETF1125 | ETF1126 | ETF1126SS | ETF1125P(ga) |
| 1-1/4 | 31.75 | 10-23 | 1.032 - 1.166 | 26.21 - 29.62 | ETF1250 | ETF1256 | ETF1256SS | ETF1250P(ga) |
| 1-3/8 | 34.93 | 10-23 | 1.157 - 1.291 | 29.39 - 32.79 | ETF1375 | ETF1376 | ETF1376SS | ETF1375P(ga) |
| 1-1/2 | 38.10 | 10-23 | 1.282 - 1.416 | 32.56 - 35.97 | ETF1500 | ETF1506 | ETF1506SS | ETF1500P(ga) |

*Specify Non-Ferrous or Stainless Steel Tool Bit when ordering.





Model 447000



Model P5154

Electric Motors

| Motor | RPM | Voltage | Hz | Amps |
|------------|--|---------|-------|------|
| 447000 | Low Gear: 60-140 High Gear: 200-470 | 110 | 50/60 | 16 |
| 447000-220 | | 220 | | 8 |

Motors are supplied with a 5/8" Jacob's chuck and 3/4" Square Female Socket Adapter.

Pneumatic Motors

| Motor | RPM | Air Usage | Air Supply Hose |
|--------|-----|--------------------------|-------------------------------|
| P5154 | 325 | 23 cfm @ 90PSI (6.2 bar) | 1/4" NPTF - 5/16" (8mm) ID |
| P5476C | 100 | | |

1/2" Jacob's chuck.



TUBE PILOTS/GUIDES

Tube Size

- 0.500" to 1.500" OD
- (12.7 to 38.1mm) OD



Elliott's 63 Series Tube Pilots, also known as Tube Guides, are used to pilot tubes through tube sheets and tube support plates that are commonly found in heat exchangers.

The Tube Pilots consist of an aluminum tapered nose attached to a replaceable nylon brush. The nylon brush fits in the end of a tube, centering and holding the pilot firmly in place.

One Tube Pilot works for several gauges within a particular tube OD, saving you money and inventory space.

Features & Benefits:

- Saves time and labor costs through faster guiding of replacement tubes through tube sheets & support plates.
- Nylon brush centers hold pilot in place, cleans the tube where it will be rolled.

Spares & Accessories:

- Nylon brushes

63 series tube pilot includes:

- Aluminum tapered nose with a replaceable nylon brush attached.

| Tube OD | Wall Gauge Range | Tube Pilot Part Number | Nylon Brush Part # |
|--------------------|------------------|------------------------|--------------------|
| 1/2" (12.7mm) | 13-16 | 6308-1316 | P5022-437 |
| | 17-22 | 6308-1722 | P5022-500 |
| 5/8" (15.9mm) | 10-12 | 6310-1012 | P5022-472 |
| | 13-16 | 6310-1316 | P5022-562 |
| | 17-22 | 6310-1722 | P5022-625 |
| 3/4" (19.1mm) | 10-12 | 6312-1012 | P5022-602 |
| | 13-16 | 6312-1316 | P5022-687 |
| 7/8" (22.2mm) | 17-22 | 6312-1722 | P5022-750 |
| | 10-12 | 6314-1012 | P5022-730 |
| 1" (25.4mm) | 13-16 | 6314-1316 | P5022-812 |
| | 17-22 | 6314-1722 | P5022-875 |
| | 10-12 | 6316-1012 | P5022-812 |
| 1-1/8" (28.6mm) | 13-16 | 6316-1316 | P5022-937 |
| | 17-22 | 6316-1722 | P5022-1000 |
| | 10-12 | 6318-1012 | P5022-985 |
| 1-1/4" (31.8mm) | 13-16 | 6318-1316 | P5022-1316 |
| | 17-22 | 6318-1722 | P5022-1091 |
| | 10-12 | 6320-1012 | P5022-1125 |
| 1-1/2" (38.1mm) | 13-16 | 6320-1316 | P5022-1188 |
| | 17-22 | 6320-1722 | P5022-1269 |
| | 10-12 | 6324-1012 | P5022-1312 |
| 1-1/2" (38.1mm) | 13-16 | 6324-1316 | P5022-1438 |
| | 17-22 | 6324-1722 | P5022-1500 |





Elliott's Lubricants are engineered to provide the best lubrication in tube rolling and roll beading applications. They will provide time and tool savings compared to commonly available lubricants.

| Application | Water Soluble | Lubricant Series |
|---------------------------------|---------------|---------------------------|
| Tube Rolling | Yes | Paste Series P8782 |
| Tube Rolling | Yes | Liquid Series P8395 |
| Roll Beading | No | Bead Coolant Series P8784 |
| Tube Trimming, Facing & Cutting | No | Cutting Oil Series P8790 |

| Lubricant Type | Size | Part Number |
|--|----------|-------------|
| Paste | Quart | P8782 |
| Paste | Gallon | P8782A |
| Paste | 5 Gallon | P8782B |
| Liquid | Quart | P8395 |
| Liquid | Gallon | P8395A |
| Liquid | 5 Gallon | P8395B |
| Bead Coolant | Gallon | P8784A |
| Bead Coolant | 5 Gallon | P8784B |
| Cutting Oil | 4 oz | P8790A |
| Cutting Oil | Gallon | P8790B |
| Pneumatic Oil | 16 oz | 900082P |
| Bead Roll Grease (For use in 4480-20-26 Grease Gun) | 14.5 oz | 4480-20-30 |



900 SERIES

Flaring Boiler Expanders

Tube Size

- 0.620" to 1.500" OD
- (15.4 to 38.1mm) OD

Type

- Flaring Boiler Expander

Application

- Superheaters in watertube boilers or evaporator tubes



Elliott's 900 Series Flaring Boiler Expanders are self-feeding, specifically made for use in superheaters in watertube boilers or evaporator tubes. In only one operation, these expanders roll and flare projecting tube ends at 15 degrees from the tool center line.

The expanding rolls will roll tubes ¼" (6.4mm) beyond the tube sheet thickness. The three flare rolls provide faster, more uniform flaring than other flaring expander models. The generous roll radius eliminates sharp offset within the tube. Additionally, the mandrel nut enables the assembly of the expander, mandrel, and drive as one unit.

Features & Benefits:

- 3 flare rolls for faster, more uniform flaring. Works evenly to the tube minimizing stress.
- Expander is self-feeding. In one operation expands and flares at 15 degrees.
- Specifically made for use in superheaters in watertube boilers or evaporator tubes. Readily available for evaporator tubes.

Mandrels are sold separately so users can choose from among a variety of mandrels best suited for their needs. Be sure to select a mandrel from the spares & accessories section below.

Spares & Accessories:

- Drum Mandrel: 10 1/2" (266.7mm) to 17 1/2" (444.5mm) long.
- Header Mandrel: For reaching through a header or water leg.
- 700 Series Short Mandrel: 7 1/4" (184.2mm) long. May require up to 2 mandrels to obtain full expansion range of the expander.
- 500 Series Short Mandrel: 5 1/2" (139.7mm) long. May require up to 2 mandrels to obtain full expansion range of the expander.
- Roll Set.
- Tube Rolling Lubricant *See page 19 for part numbers.*



900 SERIES

Flaring Boiler Expanders

| Specifications / Tool Number for Sheet Thickness | | Roll Dimensions | |
|--|----|-----------------|-----------------|
| Tube Sheet Thickness | xx | Overall Length | Eff. Length |
| 1/2" - 7/8" (12.7 - 22.2mm) | 15 | 1.000" (25.4mm) | .750" (19.1mm) |
| 1" - 1-3/8" (25.4 - 35mm) | 21 | 1.500" (38.1mm) | 1.250" (31.8mm) |
| 1-1/2" - 1-7/8" (38.1 - 47.6mm) | 23 | 2.000" (50.8mm) | 1.75" (44.5mm) |
| 2" - 2-3/8" (50.8 - 60.3mm) | 25 | 2.500" (63.5mm) | 2.250" (57.2mm) |

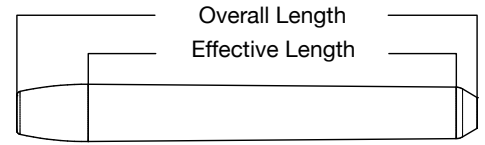

xx signifies tube sheet thickness. Enter two digits for desired roll length for expander and roll set part numbers.

| Outside Tube Diameter and BWG | Part Number | Expansion Range | | | | Roll Set Number | Drum Mandrel | Header Mandrel | Short Mandrel Kits | |
|-------------------------------|-------------|-----------------|-------|--------|-------|-----------------|--------------|----------------|----------------------------------|----------------------------------|
| | | Inch | | Metric | | | | | Mandrel Length: 7.25" (184.15mm) | Mandrel Length: 5.50" (139.70mm) |
| | | Min. | Max. | Min. | Max. | | | | | |
| 5/8" X 16 | 9xx-03164 | 0.485 | 0.546 | 12.32 | 13.87 | 9xx-21 | | | | |
| 5/8" X 17 | 9xx-00102 | 0.5 | 0.562 | 12.7 | 14.27 | 9xx-22 | 9003XD21 | 9003XH21 | 9003X721 | 9003X52-1 |
| 5/8" X 18 | 9xx-03364 | 0.515 | 0.578 | 13.08 | 14.68 | 9xx-23 | | | | |
| 5/8" X 19 | 9xx-01732 | 0.531 | 0.593 | 13.49 | 15.06 | 9xx-23 | | | | |
| 5/8" X 20 | 9xx-03564 | 0.546 | 0.609 | 13.87 | 15.47 | 9xx-24 | 9003XD22 | 9003XH22 | 9003X722 | 9003X52-2 |
| 3/4" X 14 | 9xx-00916 | 0.562 | 0.625 | 14.27 | 15.88 | 9xx-25 | | | | |
| 3/4" X 15 | 9xx-01932 | 0.593 | 0.656 | 15.06 | 16.66 | 9xx-26 | 9003XD23 | 9003XH23 | 9003X72-1 | 9003X52-3 |
| 3/4" X 16 | 9xx-03964 | 0.609 | 0.687 | 15.47 | 17.45 | 9xx-27 | | | | |
| 3/4" X 17 | 9xx-00508 | 0.625 | 0.703 | 15.88 | 17.86 | 9xx-27 | | | | |
| 3/4" X 18 | 9xx-04164 | 0.64 | 0.718 | 16.26 | 18.24 | 9xx-28 | 9003XD24 | 9003XH24 | 9003X72-2 | 9003X52-4 |
| 3/4" X 19 | 9xx-02132 | 0.656 | 0.75 | 16.66 | 19.05 | 9xx-31 | | | | |
| 3/4" X 20 | 9xx-04364 | 0.671 | 0.765 | 17.04 | 19.43 | 9xx-32 | 9003XD31 | 9003XH31 | 9003X73-1 | 9003X53-1 |
| 7/8" X 14 | 9xx-01116 | 0.687 | 0.781 | 17.45 | 19.84 | 9xx-33 | | | | |
| 7/8" X 15 | 9xx-04564 | 0.703 | 0.796 | 17.86 | 20.22 | 9xx-34 | | | | |
| 7/8" X 16 | 9xx-02332 | 0.718 | 0.812 | 18.24 | 20.62 | 9xx-34 | | | | |
| 7/8" X 17 | 9xx-04764 | 0.734 | 0.828 | 18.64 | 21.03 | 9xx-35 | 9003XD32 | 9003XH32 | 9003X73-2 | 9003X53-2 |
| 7/8" X 18 | 9xx-00304 | 0.75 | 0.843 | 19.05 | 21.41 | 9xx-36 | | | | |
| 7/8" X 19 | 9xx-04964 | 0.765 | 0.859 | 19.43 | 21.82 | 9xx-36 | | | | |
| 1" X 13 | 9xx-02532 | 0.781 | 0.875 | 19.84 | 22.23 | 9xx-37 | 9003XD33 | 9003XH33 | 9003X73-3 | 9003X53-3 |
| 1" X 14-15 | 9xx-01316 | 0.812 | 0.921 | 20.62 | 23.39 | 9xx-38 | | | | |
| 1" X 16-17 | 9xx-02732 | 0.843 | 0.953 | 21.41 | 24.21 | 9xx-40 | 9003XD34 | 9003XH34 | 9003X73-4 | 9003X53-4 |
| 1" X 18-19 | 9xx-00708 | 0.875 | 0.985 | 22.23 | 25.02 | 9xx-41 | 9003XD35 | 9003XH35 | 9003X73-5 | 9003X53-5 |
| 1-1/4" X 9 | 9xx-02932 | 0.906 | 1.015 | 23.01 | 25.78 | 9xx-42 | | | | |
| 1-1/4" X 10 | 9xx-01516 | 0.937 | 1.045 | 23.8 | 26.54 | 9xx-44 | 9003XD36 | 9003XH36 | 9003X73-6 | 9003X53-6 |
| 1-1/4" X 11 | 9xx-03132 | 0.968 | 1.093 | 24.59 | 27.76 | 9xx-52 | 9003TD51 | 9003TH51 | 9003T751 | 9003T55-1 |
| 1-1/4" X 12 | 9xx-10000 | 1 | 1.125 | 25.4 | 28.58 | 9xx-53 | | | | |
| 1-1/4" X 13 | 9xx-10132 | 1.032 | 1.156 | 26.21 | 29.36 | 9xx-55 | 9003TD52 | 9003TH52 | 9003T752 | 9003T55-2 |
| 1-1/4" X 14-15 | 9xx-10116 | 1.062 | 1.187 | 26.97 | 30.15 | 9xx-56 | 9003TD53 | 9003TH53 | 9003T753 | 9003T55-3 |
| 1-1/4" X 16-17 | 9xx-10332 | 1.093 | 1.234 | 27.76 | 31.34 | 9xx-57 | | | | |
| 1-1/4" X 18-19 | 9xx-10108 | 1.125 | 1.265 | 28.58 | 32.13 | 9xx-59 | 9003TD54 | 9003TH54 | 9003T75-1 | 9003T55-4 |
| 1-1/2" X 9 | 9xx-10532 | 1.156 | 1.296 | 29.36 | 32.92 | 9xx-60 | 9003TD55 | 9003TH55 | 9003T75-2 | 9003T55-5 |
| 1-1/2" X 10 | 9xx-10316 | 1.187 | 1.32 | 30.15 | 33.53 | 9xx-61 | | | | |
| 1-1/2" X 11 | 9xx-10732 | 1.218 | 1.359 | 30.94 | 34.52 | 9xx-63 | 9003TD56 | 9003TH56 | 9003T75-3 | 9003T55-6 |
| 1-1/2" X 12 | 9xx-10104 | 1.25 | 1.421 | 31.75 | 36.09 | 9xx-64 | | | | |
| 1-1/2" X 13 | 9xx-11764 | 1.265 | 1.437 | 32.13 | 36.5 | 9xx-65 | 9003TD57 | 9003TH57 | 9003T75-4 | 9003T55-7 |
| 1-1/2" X 14 | 9xx-10932 | 1.281 | 1.453 | 32.54 | 36.91 | 9xx-65 | | | | |
| 1-1/2" X 15-16 | 9xx-10516 | 1.312 | 1.481 | 33.32 | 37.62 | 9xx-67 | 9003TD58 | 9003TH58 | 9003T75-5 | 9003T55-8 |
| 1-1/2" X 17-18 | 9xx-11132 | 1.343 | 1.515 | 34.11 | 38.48 | 9xx-68 | 9003TD59 | 9003TH59 | 9003T75-6 | 9003T55-9 |



IMPACT ON STRESS CORROSION RISK

Stress corrosion cracking is a common tube failure mode in corrosive environments, which can lead to significant downtime and cost. While there are many different factors that can influence the occurrence of stress corrosion, it's largely related to the amount of stress the tube material is under during fabrication and operation. Optimizing the manufacturing process to minimize residual stress can help reduce the likelihood of stress corrosion cracking from occurring.

STRESS CORROSION & TUBE EXPANSION

Looking at fabrication, there are several operations that impart stress on the tube material, a primary source being tube expansion.

Two common types of mechanical expansion are parallel and tapered roll expanders. Parallel Roll, also referred to as Parallel Pin, is designed so the roll and expander are aligned with a zero-degree feed angle. This orientation requires an outside force to act on the mandrel to drive it forward, typically done using a hydraulic or electrically driven system. Alternatively, tapered roll expanders use a feed angle on the roll orientation, allowing the mandrel to draw forward as the tool is rotated.

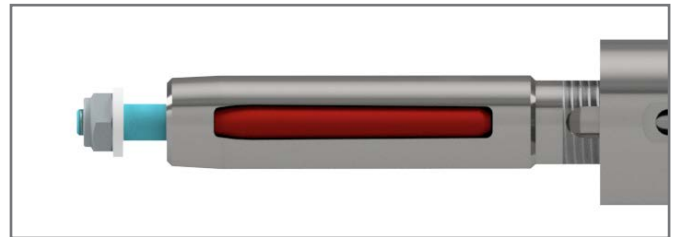

Figure 1. Parallel Roll Expander

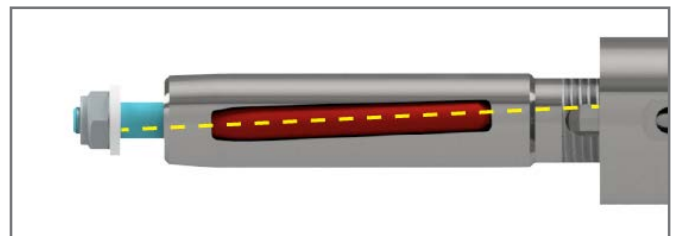

Figure 2. Tapered Roll Expander

The Experiment: Comparing Tapered & Parallel Pin

To understand what role tube expansion might have in stress corrosion cracking, Elliott conducted a study to look at the amount of stress these two methods of expansion might produce by looking at the presence of shear bands. Shear bands are a microstructure feature that develops in the material grains as a result of plastic deformation, appearing as lines inside grain boundaries.

The material selected for testing was SA213 316 Stainless Steel, $\frac{3}{4}$ " x 14BWG minimum wall tubing expanded into 2" thick 316 Stainless Steel tube sheets. The tube sheets for this experiment had 19 tube holes each and were manufactured by Elliott Tool Technologies to meet TEMA standards for triangular pitch and tube sheet hole grooves, as seen in Figure 2.

All tubes were all expanded in one operation using Elliott's Ultra Hawk assisted rolling system at 600 RPM. The tested tools utilized common components, with roll orientation being the only functional difference.

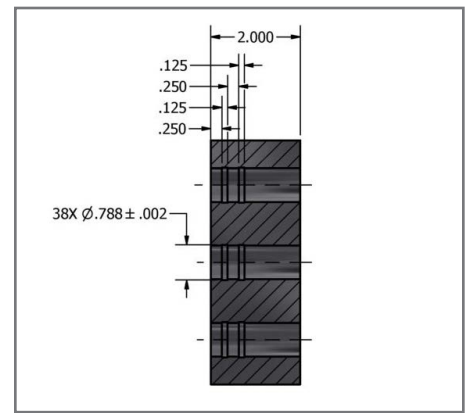
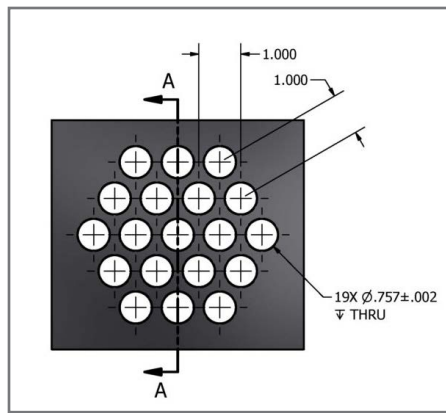

Figure 3 & 4. Tube Sheet Design

Greater Evidence Of Shear Banding In Tapered Pin At Higher Wall Reduction

After the tubes were expanded, the tube sheets were sectioned using a wire EDM and sent out for review. Metallographic samples revealed at 3% and 4% wall reduction the difference in identifiable shear bands is roughly the same between tapered and parallel pin. However, the differences become more pronounced at 6% wall reduction. Tapered pin expansion saw deeper shear banding, and as a result more residual stress, at a higher wall

reduction compared to parallel pin. Figures 3 & 4 show etched microstructures at 200x magnification. Both samples indicate some level of shear banding, but the tapered pin image shows a higher amount of shear banding on the ID surface of the tube. Elliott attributes this to be a result of the tapered roll expander generating drag along the length of the tube across the surface during expansion.

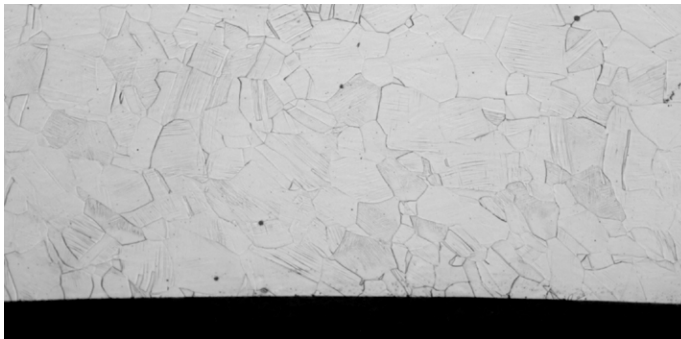

Figure 5. Parallel Pin Expansion at 6% Wall Reduction

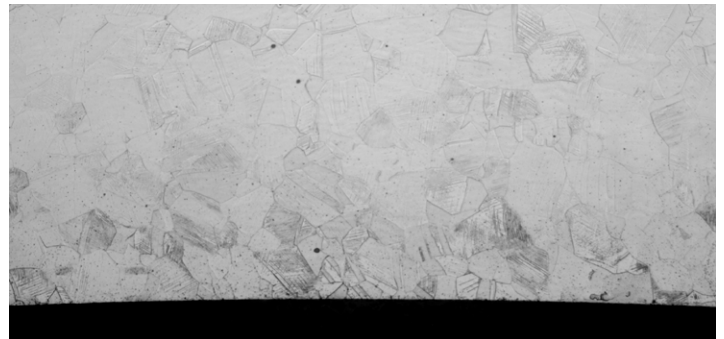

Figure 6. Tapered Pin Expansion at 6% Wall Reduction

CONCLUSIONS & INDUSTRY IMPLICATIONS

Premature tube failure is one of the leading causes of downtime in the field. Reducing any avenue for tube failure can help reduce downtime and costs. Since stress corrosion cracking failures can affect many tubes simultaneously, finding methods to reduce the likelihood of cracking would greatly reduce the cost of emergency repairs or retube efforts.

Based on Elliott's research, stress corrosion cracking is more likely to occur at higher wall reduction percentages ($\geq 6\%$), with tapered roll expansion producing more pronounced shear banding. As a result, parallel pin expansion could reduce the likelihood of this type of failure from occurring by limiting the residual stress imparted on to the surface during expansion.

1500 SERIES

Flaring Boiler Expanders

Tube Size

- 1.750" to 4.000" OD
- (44.5 to 101.6mm) OD

Type

- Flaring Boiler Expander

Application

- Firetube & Watertube Boilers



Elliott's 1500 Series Flaring Boiler Expanders are self-feeding, specifically made for use in firetube and watertube boilers.

The 1500 Series Expanders are manufactured from high quality tool steels to assure for long life under the toughest of conditions.

Features & Benefits:

- Most commonly used expander in installation of new boiler tubes due to its solid design and self-feeding rolling operation.
- High quality steel for the most demanding water tube boiler applications.
- Roll retainers hold the rolls in place when changing mandrels.

Mandrels are sold separately so users can choose from among a variety of mandrels best suited for their needs. Be sure to select a mandrel from the Spares & Accessories section below.

Spares & Accessories:

- Drum Mandrel: 10-1/2" (266.7mm) to 17-1/2" (444.5mm) long.
- Header Mandrel: For reaching through a header or water leg.
- Short Mandrel: 6-1/4" (158.8mm) long. May require two or more mandrels to obtain full expansion range of the expander.
- Roll Set: Consists of two each expanding roll, flaring roll, overlapping roll, and one set of roll retainer pins.
- Tube Rolling Lubricant *See page 19 for part numbers.*



1500 SERIES

Flaring Boiler Expanders

1500 SERIES

| Specifications / Tool Number for Sheet Thickness | | Roll Dimensions* | |
|--|----|------------------|-----------------|
| Tube Sheet Thickness | xx | Overall Length | Eff. Length |
| 1/2" - 7/8" (12.7 - 22.2mm) | 15 | 1.500" (38.1mm) | .875" (22.2mm) |
| 1" - 1-3/8" (25.4 - 34.9mm) | 21 | 2.000" (50.8mm) | 1.375" (34.9mm) |
| 1-1/2" - 1-7/8" (38.1 - 47.6mm) | 23 | 2.500" (63.5mm) | 1.875" (47.6mm) |
| 2" - 2-3/8" (50.8 - 60.3mm) | 25 | 3.000" (76.2mm) | 2.375" (60.3mm) |
| 2-1/2" - 2-7/8" (63.5 - 73.0mm) | 27 | 3.500" (88.9mm) | 2.875" (73.0mm) |
| 3" - 3-3/8" (76.2 - 85.7mm) | 29 | 4.000" (101.6mm) | 3.375" (85.7mm) |

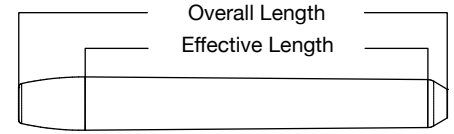

xx signifies tube sheet thickness.

| Outside Tube Diameter and BWG | Part Number | Expansion Range | | | | Enters Hand Hole Diameter | | Roll Set Number | Drum Mandrel | Header Mandrel | Short Mandrel Kits | Long Mandrel Kits |
|-------------------------------|-------------|-----------------|-------|--------|--------|---------------------------|--------|-----------------|--------------|----------------|--------------------------------|---------------------------------|
| | | Inch | | Metric | | Inch | mm | | | | Mandrel Length: 5.5" (139.7mm) | Mandrel Length: 7.25" (184.2mm) |
| | | Min. | Max. | Min. | Max. | | | | | | | |
| 1-3/4" X 9-10 | 15xx-10308 | 1.375 | 1.560 | 35.92 | 39.62 | 1-3/4" | 44.45 | 15xx-1 | 150003CD1PX | 150003CH1PX | 150003D-1 | 150003E-1 |
| 1-3/4" X 11-12 | 15xx-10716 | 1.437 | 1.625 | 36.64 | 41.27 | 1-13/16" | 46.02 | 15xx-2 | | | | |
| 1-3/4" X 13-14 | 15xx-10102 | 1.500 | 1.687 | 38.1 | 42.85 | 1-7/8" | 47.63 | 15xx-3 | | | | |
| 2" X 7-8 | 15xx-10916 | 1.562 | 1.750 | 39.67 | 44.45 | 1-15/16" | 49.20 | 15xx-4 | 150003CD3PX | 150003CH3PX | 150003D-2 | 150003E-2 |
| 2" X 9-10 | 15xx-10508 | 1.625 | 1.812 | 41.28 | 46.02 | 2" | 50.80 | 15xx-5 | | | | |
| 2" X 11-12 | 15xx-11116 | 1.687 | 1.937 | 42.85 | 49.2 | 2-1/16" | 52.37 | 15xx-6 | | | | |
| 2" X 13-14 | 15xx-10304 | 1.750 | 2.000 | 44.45 | 50.8 | 2-1/8" | 53.66 | 15xx-7 | 150003MD5PX | 150003MH5PX | 150003N-1 | 150003B-1 |
| 2-1/4" X 9-10 | 15xx-10708 | 1.875 | 2.125 | 47.62 | 53.97 | 2-1/4" | 57.15 | 15xx-8 | | | | |
| 2-1/4" X 11-12 | 15xx-11516 | 1.937 | 2.187 | 49.2 | 55.55 | 2-5/16" | 58.74 | 15xx-9 | | | | |
| 2-1/4" X 13-18 | 15xx-20000 | 2.000 | 2.250 | 50.8 | 57.15 | 2-3/8" | 60.33 | 15xx-8 | 150003MD7PX | 150003MH7PX | 150003N-2 | 150003B-2 |
| 2-1/2" X 7-8 | 15xx-20116 | 2.062 | 2.312 | 52.87 | 58.72 | 2-7/16" | 61.90 | 15xx-9 | | | | |
| 2-1/2" X 9-10 | 15xx-20108 | 2.125 | 2.375 | 53.97 | 60.32 | 2-1/2" | 63.50 | 15xx-10 | | | | |
| 2-1/2" X 11-12 | 15xx-20316 | 2.187 | 2.500 | 55.55 | 63.5 | 2-9/16" | 65.10 | 15xx-12 | 150003MD8PX | 150003MH8PX | 150003N-3 | 150003B-3 |
| 2-1/2" X 13-18 | 15xx-20104 | 2.250 | 2.562 | 57.15 | 65.07 | 2-5/8" | 66.68 | 15xx-11 | | | | |
| 3" X 3 | 15xx-20516 | 2.312 | 2.625 | 58.72 | 66.67 | 2-11/16" | 68.25 | 15xx-12 | | | | |
| 3" X 4 | 15xx-20308 | 2.375 | 2.687 | 60.32 | 68.25 | 2-3/4" | 69.85 | 15xx-13 | | | | |
| 3" X 5-6 | 15xx-20716 | 2.437 | 2.750 | 61.9 | 69.85 | 2-13/16" | 71.42 | 15xx-14 | 150003MD10PX | 150003MH10PX | 150003N-5 | 150003B-5 |
| 3" X 7 | 15xx-20102 | 2.500 | 2.812 | 63.5 | 71.42 | 2-7/8" | 73.03 | 15xx-15 | | | | |
| 3" X 8-9 | 15xx-20916 | 2.562 | 2.875 | 65.07 | 73.02 | 2-15/16" | 74.60 | 15xx-16 | | | | |
| 3" X 10-11 | 15xx-20508 | 2.625 | 2.937 | 66.67 | 74.6 | 3" | 76.20 | 15xx-17 | | | | |
| 3" X 12-13 | 15xx-21116 | 2.687 | 3.000 | 68.25 | 76.2 | 3-1/16" | 77.77 | 15xx-16 | 150003MD10PX | 150003MH10PX | 150003N-5 | 150003B-5 |
| 3-1/4" X 7 | 15xx-20304 | 2.750 | 3.062 | 69.85 | 77.77 | 3-1/8" | 79.38 | 15xx-17 | | | | |
| 3-1/4" X 8-9 | 15xx-21316 | 2.812 | 3.125 | 71.42 | 79.37 | 3-3/16" | 80.95 | 15xx-18 | | | | |
| 3-1/4" X 10-11 | 15xx-20708 | 2.875 | 3.187 | 73.02 | 80.95 | 3-1/4" | 82.55 | 15xx-19 | | | | |
| 3-1/4" X 12-13 | 15xx-21516 | 2.937 | 3.250 | 74.6 | 82.55 | 3-5/16" | 84.12 | 15xx-20 | 150003MD10PX | 150003MH10PX | 150003N-5 | 150003B-5 |
| 3-1/2" X 7 | 15xx-30000 | 3.000 | 3.375 | 76.2 | 85.72 | 3-3/8" | 85.73 | 15xx-20 | | | | |
| 3-1/2" X 8-9 | 15xx-30116 | 3.062 | 3.437 | 77.77 | 87.3 | 3-7/16" | 87.30 | 15xx-21 | | | | |
| 3-1/2" X 10-11 | 15xx-30108 | 3.125 | 3.500 | 79.37 | 88.9 | 3-1/2" | 88.90 | 15xx-22 | | | | |
| 3-1/2" X 12-13 | 15xx-30316 | 3.187 | 3.562 | 80.95 | 90.47 | 3-9/16" | 90.47 | 15xx-23 | 150003MD10PX | 150003MH10PX | 150003N-5 | 150003B-5 |
| 4" X 2 | 15xx-30104 | 3.250 | 3.625 | 82.55 | 92.07 | 3-5/8" | 92.08 | 15xx-24 | | | | |
| 4" X 3 | 15xx-30516 | 3.312 | 3.687 | 84.12 | 93.65 | 3 11/16" | 93.65 | 15xx-25 | | | | |
| 4" X 4 | 15xx-30308 | 3.375 | 3.750 | 85.72 | 95.25 | 3-3/4" | 95.25 | 15xx-24 | | | | |
| 4" X 5-6 | 15xx-30716 | 3.437 | 3.812 | 87.3 | 96.82 | 3-13/16" | 96.82 | 15xx-25 | 150003MD10PX | 150003MH10PX | 150003N-5 | 150003B-5 |
| 4" X 7 | 15xx-30102 | 3.500 | 3.875 | 88.9 | 98.42 | 3-7/8" | 98.43 | 15xx-26 | | | | |
| 4" X 8-9 | 15xx-30916 | 3.562 | 3.937 | 90.47 | 100.0 | 3-15/16" | 100.00 | 15xx-27 | | | | |
| 4" X 10-11 | 15xx-30508 | 3.625 | 4.000 | 92.07 | 101.6 | 4" | 101.60 | 15xx-28 | | | | |
| 4" X 12-13 | 15xx-31116 | 3.687 | 4.062 | 93.65 | 103.17 | 4-1/16" | 103.17 | 15xx-27 | | | | |

For sizes larger than shown, contact Customer Service for details.



3400 SERIES

Flaring Boiler Expanders

Tube Size

- 1.500" to 4.000" OD
- (38.1 to 101.6mm) OD

Type

- Flaring Boiler Expander

Application

- Firetube & Watertube Boilers



Elliott's 3400 Series Flaring Boiler Expanders are the recommended tube expanders for flaring tubes in watertube and firetube boilers.

The prong style collar allows for uniform flare lengths as well as torque controlled tube rolling to obtain uniform expanded joints.

The 3400 Series Expanders are manufactured from high quality tool steels to assure for long life under the toughest of conditions.

Features & Benefits:

- Prong style thrust collar - uniform flare lengths without risk of driving flare rolling into tube sheet.
- High quality steel for the most demanding boiler applications.

Mandrels are sold separately so users can choose from among a variety of mandrels best suited for their needs. Be sure to select a mandrel from the Spares & Accessories section below.

Spares & Accessories:

- Drum Mandrel: Most commonly used mandrel. Best used when tube sheet is readily accessible to operator. 9-5/8" (244.5mm) to 17" (431.8mm) long.
- Header Mandrel: For reaching through a header or water leg. 18" (457.2mm) to 25" (635.0mm) long.
- Short Mandrel: Used in place of Drum Mandrel when working in tight areas or where tube bends too quickly. May require two or more mandrels to obtain full expansion range of the expander. 6-1/4" (158.8mm) long.
- Roll Set: Consists of (3) expanding rolls, (3) flaring rolls, and (6) roll retainer pins.
- Tube Rolling Lubricant *See page 19 for part numbers.*



3400 SERIES

Flaring Boiler Expanders

| Specifications / Tool Number for Sheet Thickness | | Roll Dimensions* | |
|--|----|------------------|-----------------|
| Tube Sheet Thickness | xx | Overall Length | Eff. Length |
| 1/2" - 7/8" (12.7 - 22.2mm) | 15 | 1.500" (38.1mm) | .875" (22.2mm) |
| 1" - 1-3/8" (25.4 - 34.9mm) | 21 | 2.000" (50.8mm) | 1.375" (34.9mm) |

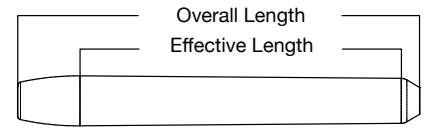

xx signifies tube sheet thickness.
 Enter two digits for desired roll length for expander and roll set part numbers.
 *Expanding Roll

| Outside Tube Diameter and BWG | Part Number | Expansion Range | | | | Roll Set Number | Drum Mandrel | Header Mandrel | Short Mandrel Kits | Short Mandrel Kits |
|-------------------------------|-------------|-----------------|--------|--------|-------|-----------------|--------------|----------------|--------------------------------|---------------------------------|
| | | Inch | | Metric | | | | | Mandrel Length: 5.5" (139.7mm) | Mandrel Length: 7.25" (184.2mm) |
| | | Min. | Max. | Min. | Max. | | | | | |
| 1-1/2" X 12 | 34xx-10104 | 1.250" | 1.421" | 31.75 | 36.09 | 34xx-64 | 9003TD57 | 9003TH57 | 9003T55-7 | 9003T75-4 |
| 1-1/2" X 13 | 34xx-11764 | 1.265" | 1.437" | 32.13 | 36.4 | 34xx-65 | | | | |
| 1-1/2" X 14 | 34xx-10932 | 1.281" | 1.453" | 32.54 | 36.9 | 34xx-65 | | | | |
| 1-1/2" X 15-16 | 34xx-10516 | 1.312" | 1.484" | 33.32 | 37.69 | 34xx-67 | 9003TD58 | 9003TH58 | 9003T55-8 | 9003T75-5 |
| 1-1/2" X 17-18 | 34xx-11132 | 1.343" | 1.515" | 34.11 | 38.48 | 34xx-68 | | | | |
| 1-3/4" X 9-10 | 34xx-10308 | 1.375" | 1.560" | 35.92 | 39.62 | 34xx-1 | 9003TD59 | 9003TH59 | 9003T55-9 | 9003T75-6 |
| 1-3/4" X 11-12 | 34xx-10716 | 1.437" | 1.625" | 36.64 | 41.27 | 34xx-2 | | | | |
| 1-3/4" X 13-14 | 34xx-10102 | 1.500" | 1.687" | 38.1 | 42.85 | 34xx-3 | | | | |
| 2" X 7-8 | 34xx-10916 | 1.562" | 1.750" | 39.67 | 44.45 | 34xx-4 | 150003CD1PX | 150003CH1PX | 150003D-1 | 150003E-1 |
| 2" X 9-10 | 34xx-10508 | 1.625" | 1.812" | 41.28 | 46.02 | 34xx-5 | | | | |
| 2" X 11-12 | 34xx-11116 | 1.687" | 1.937" | 42.85 | 49.2 | 34xx-5 | | | | |
| 2" X 13-14 | 34xx-10304 | 1.750" | 2.000" | 44.45 | 50.8 | 34xx-6 | | | | |
| 2" X 15-18 | 34xx-11316 | 1.812" | 2.062" | 46.02 | 52.37 | 34xx-7 | | | | |
| 2-1/4" X 9-10 | 34xx-10708 | 1.875" | 2.125" | 47.62 | 53.97 | 34xx-8 | | | | |
| 2-1/4" X 11-12 | 34xx-11516 | 1.937" | 2.187" | 49.2 | 55.55 | 34xx-9 | 150003CD3PX | 150003CH3PX | 150003D-2 | 150003E-2 |
| 2-1/4" X 13-18 | 34xx-20000 | 2.000" | 2.250" | 50.8 | 57.15 | 34xx-8 | | | | |
| 2-1/2" X 7-8 | 34xx-20116 | 2.062" | 2.312" | 52.87 | 58.72 | 34xx-9 | | | | |
| 2-1/2" X 9-10 | 34xx-20108 | 2.125" | 2.375" | 53.97 | 60.32 | 34xx-10 | 150003MD5PX | 150003MH5PX | 150003N-1 | 150003B-1 |
| 2-1/2" X 11-12 | 34xx-20316 | 2.187" | 2.500" | 55.55 | 63.5 | 34xx-12 | | | | |
| 2-1/2" X 13-18 | 34xx-20104 | 2.250" | 2.562" | 57.15 | 65.07 | 34xx-11 | | | | |
| 3" X 3 | 34xx-20516 | 2.312" | 2.625" | 58.72 | 66.67 | 34xx-12 | 150003MD7PX | 150003MH7PX | 150003N-2 | 150003B-2 |
| 3" X 4 | 34xx-20308 | 2.375" | 2.687" | 60.32 | 68.25 | 34xx-13 | | | | |
| 3" X 5-6 | 34xx-20716 | 2.437" | 2.750" | 61.9 | 69.85 | 34xx-14 | | | | |
| 3" X 7 | 34xx-20102 | 2.500" | 2.812" | 63.5 | 71.42 | 34xx-15 | | | | |
| 3" X 8-9 | 34xx-20916 | 2.562" | 2.875" | 65.07 | 73.02 | 34xx-16 | | | | |
| 3" X 10-11 | 34xx-20508 | 2.625" | 2.937" | 66.67 | 74.6 | 34xx-17 | | | | |
| 3" X 12-13 | 34xx-21116 | 2.687" | 3.000" | 68.25 | 76.2 | 34xx-16 | 150003MD8PX | 150003MH8PX | 150003N-3 | 150003B-3 |
| 3-1/4" X 7 | 34xx-20304 | 2.750" | 3.062" | 69.85 | 77.77 | 34xx-17 | | | | |
| 3-1/4" X 8-9 | 34xx-21316 | 2.812" | 3.125" | 71.42 | 79.37 | 34xx-18 | | | | |
| 3-1/4" X 10-11 | 34xx-20708 | 2.875" | 3.187" | 73.02 | 80.95 | 34xx-19 | 150003MD9PX | 150003MH9PX | 150003N-4 | 150003B-4 |
| 3-1/4" X 12-13 | 34xx-21516 | 2.937" | 3.250" | 74.6 | 82.55 | 34xx-20 | | | | |
| 3-1/2" X 7 | 34xx-30000 | 3.000" | 3.375" | 76.2 | 85.72 | 34xx-20 | | | | |
| 3-1/2" X 8-9 | 34xx-30116 | 3.062" | 3.437" | 77.77 | 87.3 | 34xx-21 | 150003MD10PX | 150003MH10PX | 150003N-5 | 150003B-5 |
| 3-1/2" X 10-11 | 34xx-30108 | 3.125" | 3.500" | 79.37 | 88.9 | 34xx-22 | | | | |
| 3-1/2" X 12-13 | 34xx-30316 | 3.187" | 3.562" | 80.95 | 90.47 | 34xx-23 | | | | |
| 4" X 2 | 34xx-30104 | 3.250" | 3.625" | 82.55 | 92.07 | 34xx-24 | 150003MD10PX | 150003MH10PX | 150003N-5 | 150003B-5 |
| 4" X 3 | 34xx-30516 | 3.312" | 3.687" | 84.12 | 93.65 | 34xx-25 | | | | |
| 4" X 4 | 34xx-30308 | 3.375" | 3.750" | 85.72 | 95.25 | 34xx-24 | | | | |
| 4" X 5-6 | 34xx-30716 | 3.437" | 3.812" | 87.3 | 96.82 | 34xx-25 | | | | |
| 4" X 7 | 34xx-30102 | 3.500" | 3.875" | 88.9 | 98.42 | 34xx-26 | | | | |
| 4" X 8-9 | 34xx-30916 | 3.562" | 3.937" | 90.47 | 100.0 | 34xx-27 | | | | |
| 4" X 10-11 | 34xx-30508 | 3.625" | 4.000" | 92.07 | 101.6 | 34xx-28 | | | | |

For sizes larger than shown, contact Customer Service for details.



3300 SERIES

Straight Boiler Expanders

Tube Size

- 1.500" to 4.000" OD
- (38.1 to 101.6mm) OD

Type

- Straight Boiler Expander

Application

- Firetube & Self-Contained Steam Boiler Units



Elliott's 3300 Series Straight Boiler Expanders are the preferred tube expanders for firetube boilers and self-contained steam boiler units.

The standard expanders are provided with thrust collars for rolling tubes flush to the tube sheet. Prong style collars are also available for tube ends extending beyond the tube sheet face.

Features & Benefits:

- For performing a straight roll operation or re-rolling leaky joints.
- Ball bearing thrust collar prevents force feed of expander into tube.
- High quality steel for the most demanding boiler applications.

Mandrels are sold separately so users can choose from among a variety of mandrels best suited for their needs. Be sure to select a mandrel from the Spares & Accessories section below.

Spares & Accessories:

- Drum Mandrel: Most commonly used mandrel. Best used when tube sheet is readily accessible to operator. 9-5/8" (244.5mm) to 17" (431.8mm) long.
- Header Mandrel: For reaching through a header or water leg. 18" (457.2mm) to 25" (635.0mm) long.
- Short Mandrel: Used in place of Drum Mandrel when working in tight areas or where tube bends too quickly. May require two or more mandrels to obtain full expansion range of the expander. 6-1/4" (158.8mm) long.
- Roll Set: Consists of (3) straight rolls and (6) roll retainer pins
- Tube Rolling Lubricant **See page 19 for part numbers.**
- Prong Style Collar: Available upon request to accommodate tube projection.



3300 SERIES

Straight Boiler Expanders

3300 SERIES

| Specifications / Tool Number for Sheet Thickness | | Roll Dimensions | |
|--|----|------------------|-----------------|
| Tube Sheet Thickness | xx | Overall Length | Eff. Length |
| 1/2" - 7/8" (12.7 - 22.2mm) | 15 | 1.500" (38.1mm) | 0.875" (22.2mm) |
| 1" - 1-3/8" (25.4 - 34.9mm) | 21 | 2.000" (50.8mm) | 1.375" (34.9mm) |
| 1-1/2" - 1-7/8" (38.1 - 47.6mm) | 23 | 2.500" (63.5mm) | 1.875" (47.6mm) |
| 2" - 2-3/8" (50.8 - 60.3mm) | 25 | 3.000" (76.2mm) | 2.375" (60.3mm) |
| 2-1/2" - 2-7/8" (63.5 - 73.0mm) | 27 | 3.500" (88.9mm) | 2.875" (73.0mm) |
| 3" - 3-3/8" (76.2 - 85.7mm) | 29 | 4.000" (101.6mm) | 3.375" (85.7mm) |

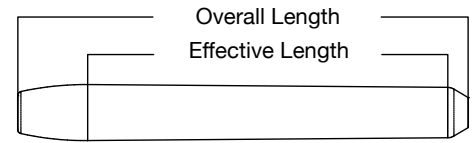

xx signifies tube sheet thickness. Enter two digits for desired roll length for expander and roll set part numbers.

| Outside Tube Diameter and BWG | Part Number | Expansion Range | | | | Roll Set Number | Drum Mandrel | Header Mandrel | Short Mandrel Kits | Long Mandrel Kits |
|-------------------------------|-------------|-----------------|--------|--------|-------|-----------------|--------------|----------------|--------------------------------|---------------------------------|
| | | Inch | | Metric | | | | | Mandrel Length: 5.5" (139.7mm) | Mandrel Length: 7.25" (184.2mm) |
| | | Min. | Max. | Min. | Max. | | | | | |
| 1-1/2" X 12 | 33xx-10104 | 1.250" | 1.421" | 31.75 | 36.09 | 33xx-64A | 9003TD57 | 9003TH57 | 9003T55-7 | 9003T75-4 |
| 1-1/2" X 13 | 33xx-11764 | 1.265" | 1.437" | 32.13 | 36.4 | 33xx-65A | | | | |
| 1-1/2" X 14 | 33xx-10932 | 1.281" | 1.453" | 32.54 | 36.9 | 33xx-65A | | | | |
| 1-1/2" X 15-16 | 33xx-10516 | 1.312" | 1.484" | 33.32 | 37.69 | 33xx-67A | 9003TD58 | 9003TH58 | 9003T55-8 | 9003T75-5 |
| 1-1/2" X 17-18 | 33xx-11132 | 1.343" | 1.515" | 34.11 | 38.48 | 33xx-68A | | | | |
| 1-3/4" X 9-10 | 33xx-10308 | 1.375" | 1.560" | 35.92 | 39.62 | 33xx-1A | | | | |
| 1-3/4" X 11-12 | 33xx-10716 | 1.437" | 1.625" | 36.64 | 41.27 | 33xx-2A | 150003CD1PX | 150003CH1PX | 150003D-1 | 150003E-1 |
| 1-3/4" X 13-14 | 33xx-10102 | 1.500" | 1.687" | 38.1 | 42.85 | 33xx-3A | | | | |
| 2" X 7-8 | 33xx-10916 | 1.562" | 1.750" | 39.67 | 44.45 | 33xx-4A | | | | |
| 2" X 9-10 | 33xx-10508 | 1.625" | 1.812" | 41.28 | 46.02 | 33xx-5A | 150003CD3PX | 150003CH3PX | 150003D-2 | 150003E-2 |
| 2" X 11-12 | 33xx-11116 | 1.687" | 1.937" | 42.85 | 49.2 | 33xx-5A | | | | |
| 2" X 13-14 | 33xx-10304 | 1.750" | 2.000" | 44.45 | 50.8 | 33xx-6A | | | | |
| 2" X 15-18 | 33xx-11316 | 1.812" | 2.062" | 46.02 | 52.37 | 33xx-7A | 150003CD3PX | 150003CH3PX | 150003D-2 | 150003E-2 |
| 2-1/4" X 9-10 | 33xx-10708 | 1.875" | 2.125" | 47.62 | 53.97 | 33xx-8A | | | | |
| 2-1/4" X 11-12 | 33xx-11516 | 1.937" | 2.187" | 49.2 | 55.55 | 33xx-9A | | | | |
| 2-1/4" X 13-18 | 33xx-20000 | 2.000" | 2.250" | 50.8 | 57.15 | 33xx-8A | 150003MD5PX | 150003MH5PX | 150003N-1 | 150003B-1 |
| 2-1/2" X 7-8 | 33xx-20116 | 2.062" | 2.312" | 52.87 | 58.72 | 33xx-9A | | | | |
| 2-1/2" X 9-10 | 33xx-20108 | 2.125" | 2.375" | 53.97 | 60.32 | 33xx-10A | | | | |
| 2-1/2" X 11-12 | 33xx-20316 | 2.187" | 2.500" | 55.55 | 63.5 | 33xx-12A | 150003MD7PX | 150003MH7PX | 150003N-2 | 150003B-2 |
| 2-1/2" X 13-18 | 33xx-20104 | 2.250" | 2.562" | 57.15 | 65.07 | 33xx-11A | | | | |
| 3" X 3 | 33xx-20516 | 2.312" | 2.625" | 58.72 | 66.67 | 33xx-12A | | | | |
| 3" X 4 | 33xx-20308 | 2.375" | 2.687" | 60.32 | 68.25 | 33xx-13A | 150003MD7PX | 150003MH7PX | 150003N-2 | 150003B-2 |
| 3" X 5-6 | 33xx-20716 | 2.437" | 2.750" | 61.9 | 69.85 | 33xx-14A | | | | |
| 3" X 7 | 33xx-20102 | 2.500" | 2.812" | 63.5 | 71.42 | 33xx-15A | | | | |
| 3" X 8-9 | 33xx-20916 | 2.562" | 2.875" | 65.07 | 73.02 | 33xx-16A | 150003MD8PX | 150003MH8PX | 150003N-3 | 150003B-3 |
| 3" X 10-11 | 33xx-20508 | 2.625" | 2.937" | 66.67 | 74.6 | 33xx-17A | | | | |
| 3" X 12-13 | 33xx-21116 | 2.687" | 3.000" | 68.25 | 76.2 | 33xx-16A | | | | |
| 3-1/4" X 7 | 33xx-20304 | 2.750" | 3.062" | 69.85 | 77.77 | 33xx-17A | 150003MD8PX | 150003MH8PX | 150003N-3 | 150003B-3 |
| 3-1/4" X 8-9 | 33xx-21316 | 2.812" | 3.125" | 71.42 | 79.37 | 33xx-18A | | | | |
| 3-1/4" X 10-11 | 33xx-20708 | 2.875" | 3.187" | 73.02 | 80.95 | 33xx-19A | | | | |
| 3-1/4" X 12-13 | 33xx-21516 | 2.937" | 3.250" | 74.6 | 82.55 | 33xx-20A | 150003MD9PX | 150003MH9PX | 150003N-4 | 150003B-4 |
| 3-1/2" X 7 | 33xx-30000 | 3.000" | 3.375" | 76.2 | 85.72 | 33xx-20A | | | | |
| 3-1/2" X 8-9 | 33xx-30116 | 3.062" | 3.437" | 77.77 | 87.3 | 33xx-21A | | | | |
| 3-1/2" X 10-11 | 33xx-30108 | 3.125" | 3.500" | 79.37 | 88.9 | 33xx-22A | 150003MD9PX | 150003MH9PX | 150003N-4 | 150003B-4 |
| 3-1/2" X 12-13 | 33xx-30316 | 3.187" | 3.562" | 80.95 | 90.47 | 33xx-23A | | | | |
| 4" X 2 | 33xx-30104 | 3.250" | 3.625" | 82.55 | 92.07 | 33xx-24A | | | | |
| 4" X 3 | 33xx-30516 | 3.312" | 3.687" | 84.12 | 93.65 | 33xx-25A | 150003MD10PX | 150003MH10PX | 150003N-5 | 150003B-5 |
| 4" X 4 | 33xx-30308 | 3.375" | 3.750" | 85.72 | 95.25 | 33xx-24A | | | | |
| 4" X 5-6 | 33xx-30716 | 3.437" | 3.812" | 87.3 | 96.82 | 33xx-25A | | | | |
| 4" X 7 | 33xx-30102 | 3.500" | 3.875" | 88.9 | 98.42 | 33xx-26A | 150003MD10PX | 150003MH10PX | 150003N-5 | 150003B-5 |
| 4" X 8-9 | 33xx-30916 | 3.562" | 3.937" | 90.47 | 100.0 | 33xx-27A | | | | |
| 4" X 10-11 | 33xx-30508 | 3.625" | 4.000" | 92.07 | 101.6 | 33xx-28A | | | | |

For sizes larger than shown, contact Customer Service for details.



DRE SERIES

Deep Roll Boiler Expanders

Tube Size

- 1.750" to 4.000" OD
- (44.5 to 101.6mm) OD

Type

- Deep Roll Boiler Expander

Application

- Steam & Mud Drums in High Pressure Boilers



Elliott's DRE Series Deep Roll Boiler Expanders are used for deep and hard rolling of steam and mud drums found in high pressure boilers.

The DRE Series Expanders are furnished with a minimum reach of 3-1/2" (88.9mm) to maximum reach of 10-1/2" (266.7mm).

The DRE and 1500 Series Boiler Expanders make a great combination for boiler tube erection and boiler tube replacement.

Features & Benefits:

- Long expanding rolls allow for a quicker & easier step-rolling operation.
- For use in heavy drum thicknesses for rolling tubes. With a reach up to 10-1/2" it ensures that any required reach or depth is easily performed with this tool.
- High quality steel for the most demanding water tube boiler applications.

Mandrels are sold separately.

Spares & Accessories:

- Header Mandrel
- Roll Set: Consists of (3) overlapping rolls and (6) roll retainer pins.
- Tube Rolling Lubricant *See page 19 for part numbers.*



DRE SERIES

Deep Roll Boiler Expanders

| Outside Tube Diameter Inches and BWG | Part Number | Expansion Range Inch | | | | Roll Set* | Header Mandrel |
|---|-------------|----------------------|--------|--------|-------|-----------|-------------------|
| | | Inch | | Metric | | | |
| | | Min. | Max. | Min. | Max. | | |
| 1-3/4" X 9-10 | DRE10308 | 1.375" | 1.560" | 35.92 | 39.62 | DRE3 | 150003CHL0 |
| 1-3/4" X 11-12 | DRE10716 | 1.437" | 1.625" | 36.64 | 41.27 | DRE4 | |
| 1-3/4" X 13-14 | DRE10102 | 1.500" | 1.687" | 38.1 | 42.85 | DRE5 | |
| 2" X 7-8 | DRE10916 | 1.562" | 1.750" | 39.67 | 44.45 | DRE6 | 150003CHL1 |
| 2" X 9-10 | DRE10508 | 1.625" | 1.812" | 41.28 | 46.02 | DRE5 | |
| 2" X 11-12 | DRE11116 | 1.687" | 1.937" | 42.85 | 49.2 | DRE7 | |
| 2" X 13-14 | DRE10304 | 1.750" | 2.000" | 44.45 | 50.8 | DRE8 | 150003MHL5 |
| 2" X 15-18 | DRE11316 | 1.812" | 2.062" | 46.02 | 52.37 | DRE9 | |
| 2-1/4" X 9-10 | DRE10708 | 1.875" | 2.125" | 47.62 | 53.97 | DRE10 | |
| 2-1/4" X 11-12 | DRE11516 | 1.937" | 2.187" | 49.2 | 55.55 | DRE11 | 150003MHL7 |
| 2-1/4" X 13-18 | DRE20000 | 2.000" | 2.250" | 50.8 | 57.15 | DRE8 | |
| 2-1/2" X 7-8 | DRE20116 | 2.062" | 2.312" | 52.87 | 58.72 | DRE9 | |
| 2-1/2" X 9-10 | DRE20108 | 2.125" | 2.375" | 53.97 | 60.32 | DRE10 | 150003MHL8 |
| 2-1/2" X 11-12 | DRE20316 | 2.187" | 2.500" | 55.55 | 63.5 | DRE12 | |
| 2-1/2" X 13-18 | DRE20104 | 2.250" | 2.562" | 57.15 | 65.07 | DRE11 | |
| 3" X 3 | DRE20516 | 2.312" | 2.625" | 58.72 | 66.67 | DRE12 | 150003MHL9 |
| 3" X 4 | DRE20308 | 2.375" | 2.687" | 60.32 | 68.25 | DRE13 | |
| 3" X 5-6 | DRE20716 | 2.437" | 2.750" | 61.9 | 69.85 | DRE14 | |
| 3" X 7 | DRE20102 | 2.500" | 2.812" | 63.5 | 71.42 | DRE15 | 150003MHL10 |
| 3" X 8-9 | DRE20916 | 2.562" | 2.875" | 65.07 | 73.02 | DRE16 | |
| 3" X 10-11 | DRE20508 | 2.625" | 2.937" | 66.67 | 74.6 | DRE17 | |
| 3" X 12-13 | DRE21116 | 2.687" | 3.000" | 68.25 | 76.2 | DRE16 | 150003MHL8 |
| 3-1/4" X 7 | DRE20304 | 2.750" | 3.062" | 69.85 | 77.77 | DRE17 | |
| 3-1/4" X 8-9 | DRE21316 | 2.812" | 3.125" | 71.42 | 79.37 | DRE18 | |
| 3-1/4" X 10-11 | DRE20708 | 2.875" | 3.187" | 73.02 | 80.95 | DRE19 | 150003MHL9 |
| 3-1/4" X 12-13 | DRE21516 | 2.937" | 3.250" | 74.6 | 82.55 | DRE20 | |
| 3-1/2" X 7 | DRE30000 | 3.000" | 3.375" | 76.2 | 85.72 | DRE20 | |
| 3-1/2" X 8-9 | DRE30116 | 3.062" | 3.437" | 77.77 | 87.3 | DRE21 | 150003MHL10 |
| 3-1/2" X 10-11 | DRE30108 | 3.125" | 3.500" | 79.37 | 88.9 | DRE22 | |
| 3-1/2" X 12-13 | DRE30316 | 3.187" | 3.562" | 80.95 | 90.47 | DRE23 | |
| 4" X 2 | DRE30104 | 3.250" | 3.625" | 82.55 | 92.07 | DRE24 | 150003MHL10 |
| 4" X 3 | DRE30516 | 3.312" | 3.687" | 84.12 | 93.65 | DRE25 | |
| 4" X 4 | DRE30308 | 3.375" | 3.750" | 85.72 | 95.25 | DRE24 | |
| 4" X 5-6 | DRE30716 | 3.437" | 3.812" | 87.3 | 96.82 | DRE25 | 150003MHL10 |
| 4" X 7 | DRE30102 | 3.500" | 3.875" | 88.9 | 98.42 | DRE26 | |
| 4" X 8-9 | DRE30916 | 3.562" | 3.937" | 90.47 | 100.0 | DRE27 | |
| 4" X 10-11 | DRE30508 | 3.625" | 4.000" | 92.07 | 101.6 | DRE28 | |

For sizes larger than shown, contact Customer Service for details.

*Effective Roll Length: 2-5/8"



40 SERIES

Straight Boiler Expanders

Tube Size

- 2.000" to 3.000" OD
- (50.8 to 76.2mm) OD

Type

- Straight Boiler Expander

Application

- Re-Rolling Leaky Tubes in Firetube Boilers By Hand



Elliott's 40 Series Straight Boiler Expanders are recommended for re-rolling leaky tube joints in firetube boilers. Self-feeding, these expanders should primarily be used by hand.

The guard prong is 1/2" (12.7mm) long, allowing you to roll boiler tubes with a projection, while also controlling the mandrel feed to prevent over-rolling.

The bronze bearing between the expander's frame and guard reduces friction and allows for torque controlled tube rolling.

Features & Benefits:

- Only for re-rolling leaky tube joints in firetube boilers.
- Tapered expansion aggressively seals leaky joints allowing for quick cycle time.
- Guard prong accommodates tube projections, allowing you to roll boiler tubes with projection while controlling the mandrel feed.
- An economical, durable tool.

Mandrels are sold separately.

Spares & Accessories:

- Drum Mandrel
- Roll Set
- Tube Rolling Lubricant *See page 19 for part numbers.*

| Outside Tube Diameter and BWG | Part Number | Expansion Range | | | | Roll Set | Drum Mandrel | Mandrel Square |
|-------------------------------|-------------|-----------------|-------|--------|-------|----------|--------------|----------------|
| | | Inch | | Metric | | | | |
| | | Min. | Max. | Min. | Max. | | | |
| 2" X 12-18 | 40-20000 | 1.718 | 2.000 | 43.64 | 50.80 | 4005-20 | 40C3P20000 | 3/4" |
| 2-1/2" X 10-18 | 40-20102 | 2.156 | 2.500 | 54.76 | 63.50 | 4005-25 | 40C3P20102 | 3/4" |
| 3" X 10-18 | 40-30000 | 2.625 | 3.000 | 66.68 | 76.20 | 4005-30 | 40M3P30000 | 1" |



UNIQUE APPLICATIONS REQUIRE CUSTOM SOLUTIONS

Take On The Toughest Applications With Custom Engineered Solutions.

With over 130 years of developmental experience, Elliott's in-house engineering team designs custom solutions for some of the industry's most unique applications.

Past Projects Include:

24' Condenser Expander
U-Joint One-Revolution Cutter
Baffle Expanders
& Much More



Learn more at elliott-tool.com or
contact us today



KELLER & ASSOCIATES INC. FINDS:

THE BEST BEAD IN THE MARKET



QUICK SUMMARY

The Challenge

- Provide the best quality work for their customers.
- Air hammer and beading tool were too labor intensive.
- Existing vendor's beading expander did not provide a smooth bead to tube sheet transition.
- Poor support from their existing vendor left them with little options.

The Solution

- Operators tested Elliott's 4480 Single Roll Beading Expander on a production job.

The Results

- Produced a smooth bead to tube sheet transition.
- Saved labor costs compared to manual beading.
- Extended tube life compared to a ridged bead transition.

The Challenge

As Operations Director of Keller & Associates Inc., a boiler contractor and repair shop in Lakeland, Florida, Ted Keller wants retube tools that will do the best job for his customers while minimizing time and costs on his end.

A roll beading expander that will roll, bead, and reroll the tube in one operation is an important tool for firetube boilers.

Keller & Associates' operators tried using an air hammer with beading tool but found that it was very time consuming since the three separate operations of rolling, beading, and re-rolling were required. Additionally, the air hammer was very hard on the body, making operators sore after just a few tubes.

Then they tried a single roll beading expander manufactured by a competitor of Elliott Tool. While the expander performed the three operations of roll, bead, and re-roll in only one function, thus saving time and labor costs, it did not produce a smooth bead to tube sheet transition. In fact, the bead had an evident lip (edge) on it.

A lip on the bead restricts the flame that is going through the firetube boiler tube which places stress on the tube. This stress decreases tube life which means that customers must get their firetube boilers retubed more often than they should need to.

Ted Keller actually called the single roll beading expander manufacturer to improve the quality of their bead since they want to do the best quality work for their firetube boiler customers. The manufacturer responded that they were working on the problem but Ted Keller never heard back!

The Solution

The Keller & Associates operators tried Elliott's Single Roll Beading Expander and immediately appreciated its key features:

Rolling and beading in one operation together with fast feeding boosts productivity.

Easy on body compared to air hammer and beading tool.

- Eliminates the high torque requirement of others' Double Roll Beading Expanders.
- Only minimal component part changes to enable expansion of different tube gauges.
- Smooth bead to tube sheet transition to increase tube life.

Although Keller & Associates were extremely pleased with all of the above features, they were most impressed with the smooth bead to tube sheet transition that Elliott's Single Roll Beading Expander produced.

In fact, Keller & Associates employees, including Ted Keller, did a side by side beading test using the Elliott expander versus the other manufacturer's expander on the same firetube boiler. All agreed that Elliott's Single Roll Beading Expander clearly provided for a better bead than the other beading expander.

Ted Keller was impressed to see that Elliott's Single Roll Beading Expander solved the problem that he was experiencing with his current roll beading expanders so that he could provide the best quality to his customers.

The Results

Elliott's Single Roll Beading Expander saves Keller & Associates on labor costs as compared with the manual method of using an air hammer and beading tool which takes three operations instead of one.

The Elliott Single Roll Beading Expander also produces a smooth bead to tube sheet transition as compared with the other single roll beading expander manufacturer. The smooth bead allows firetube boiler tubes to last longer than those with ridged beads.

Keller & Associates knows that with the Elliott Single Roll Beading Expander, they are providing the best quality to their customers.

“

I like the smooth bead to tube sheet transition because it eliminates stress on the tube to make it last longer. I have been asking another roll beading expander manufacturer to improve the quality of their bead and they said they're working on it.

Ted Keller
Operations Director



4480 SERIES

Single Roll Beading Expanders

Tube Size

- 1.500" to 3.000" OD
- (38.1 to 76.2mm) OD

Type

- Single Roll Beading Expander

Application

- Firetube Boilers



Elliott's 4480 Series Single Roll Beading Expanders expand the tube into the tube sheet while forming a bead at the end of the tube required in firetube boiler applications.

The 4480 Series combines three operations (rolling, beading, re-rolling) into one, saving significant time and money. Additionally, the single beading roll design enables standard motors to provide enough torque to successfully bead the tube.

4480 Serie Package Includes:

- Roll Beading Expander
- Mandrel
- Grease Gun

Spares & Accessories:

- Mandrel
- Front Square Drive Mandrel: Recommended in applications where space is limited and tubes must be re-rolled from behind the boiler
- Expanding Roll Set: Includes 3 or 4 overlapping rolls (depending upon expander size) and 1 expanding roll
- Guide Roll
- Bead Roll
- Grease Gun (4480-20-26) / Grease (4480-20-30)
- Bead Coolant *See page 19 for part numbers.*
- Electric and Pneumatic Rolling Motors *See page on page 60 and 74.*

Features & Benefits:

- Rolling and beading in one operation together with fast feeding boosts productivity.
- Easy on body compared to air hammer and beading tool.
- Eliminates the high torque requirement of other Single Roll Beading expanders.
- Smooth bead to tube sheet transition: increases tube life.
- Only minimal component part changes to enable expansion of different tube gauges.

“ We have used Elliott's single roll beading expander on two different retube projects so far and the finished look of the tube bead is **machine quality**. Our boilermakers said this was the best tool they have ever used. They will never pick up a pneumatic hammer and beading tool again!

Burgess J. Holt, Owner
NBW Inc



| Single Roll Beading Expander | | | | | | | | | | | |
|------------------------------|-----|-------------|---------------------|---------------------|----------------|------------|--------------------|--------------|-------------|--------------|----------------------------|
| OD | BWG | Tool Number | Expansion Range | | Bead Roll | Guide Roll | Expanding Roll Set | Mandrel | Cage | Drive Square | Front Square Drive Mandrel |
| | | | Min. | Max. | | | | | | | |
| 1-1/2" (38.1mm) | 11 | 4480-1511 | 1.260" (32.00mm) | 1.340" (34.04mm) | 4480-15011-12 | 4480-15111 | 4480-1500 | 4480-1511-02 | 4480-1511BK | 3/4" | N/A |
| | 12 | 4480-1512 | 1.282" (32.56mm) | 1.340" (34.04mm) | | 4480-15112 | | | | | |
| | 13 | 4480-1513 | 1.310" (33.27mm) | 1.390" (35.31mm) | 4480-15013-14 | 4480-15113 | | 4480-1513-02 | 4480-1513BK | | |
| | 14 | 4480-1514 | 1.334" (33.88mm) | 1.390" (35.31mm) | | 4480-15114 | | | | | |
| 2" (50.8mm) | 10 | 4480-2010 | 1.732" (43.99mm) | 1.875" (47.63mm) | 4480-20010-011 | 4480-20110 | 4480-2000 | 4480-20-02 | 4480-20BK | 3/4" | 4480-20-02FS |
| | 11 | 4480-2011 | 1.760" (44.70mm) | 1.875" (47.63mm) | 4480-20010-011 | 4480-20111 | 4480-2000 | 4480-20-02 | | | |
| | 12 | 4480-2012 | 1.782" (45.26mm) | 1.875" (47.63mm) | 4480-20012-013 | 4480-20112 | 4480-2000 | 4480-20-02 | | | |
| | 13 | 4480-2013 | 1.810" (45.97mm) | 1.875" (47.63mm) | 4480-20012-013 | 4480-20113 | 4480-2000 | 4480-20-02 | | | |
| 2.5" (63.5mm) | 10 | 4480-2510 | 2.232" (56.69mm) | 2.375" (60.33mm) | 4480-25010-011 | 4480-25110 | 4480-2500 | 4480-25-02 | 4480-25BK | 1" | 4480-25-02FS |
| | 11 | 4480-2511 | 2.260" (57.40mm) | 2.375" (60.33mm) | 4480-25010-011 | 4480-25111 | 4480-2500 | 4480-25-02 | | | |
| | 12 | 4480-2512 | 2.282" (57.96mm) | 2.375" (60.33mm) | 4480-25012-013 | 4480-25112 | 4480-2500 | 4480-25-02 | | | |
| | 13 | 4480-2513 | 2.310" (58.67mm) | 2.375" (60.33mm) | 4480-25012-013 | 4480-25113 | 4480-2500 | 4480-25-02 | | | |
| 3" (76.2mm) | 10 | 4480-3010 | 2.732" (69.39mm) | 2.900" (73.66mm) | 4480-30010-011 | 4480-30110 | 4480-3000 | 4480-30-02 | 4480-30BK | 1" | 4480-30-02FS |
| | 11 | 4480-3011 | 2.760" (70.10mm) | 2.900" (73.66mm) | 4480-30010-011 | 4480-30111 | 4480-3000 | 4480-30-02 | | | |
| | 12 | 4480-3012 | 2.782" (70.66mm) | 2.900" (73.66mm) | 4480-30012 | 4480-30112 | 4480-3000 | 4480-30-02 | | | |



Grease Gun



23 SERIES

Heat Exchanger & Condenser Expanders

Tube Size

- 0.250" – 0.375" OD
- 6.4 mm – 9.5 mm OD



Elliott's 23 Series Condenser Expanders are ideal for expanding small tubes commonly found in oil coolers and other small heat exchangers.

The 23 Series Expanders are available in both standard and longer reaches to suit your application. The 23 Series works great with Elliott's new ET720 Series Rolling Motors. With quality US manufacturing and proven tool life, the 23 Series consistently expands tubes in smaller vessels.

Spares & Accessories:

- Mandrel
- Roll Set
- Lubricant: *See page 19 for part numbers.*
- ET Series Torque Controlled Pneumatic Rolling Motors: *See page 66.*

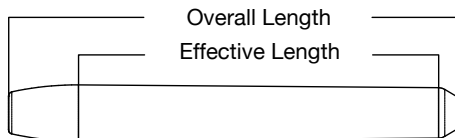

| Roll Part Number | Overall Roll Length | Effective Roll Length |
|------------------|---------------------|-----------------------|
| 231R01 - 231R17 | 0.750" (19.1mm) | 0.606" (15.4mm) |
| 232R09 - 232R17 | 1.250" (31.8mm) | 1.106" (28.1mm) |

| 3 Roll Expanders | | | | | | | | | | | |
|------------------|----------------|-------------|-----------------|-------|--------|------|---|-------|-------------------------|----------------|-------------|
| Tube Size | | | Expansion Range | | | | Tube Sheet (Min/Max Reach) 1/4" - 3/4" (6.4 - 19.1mm) Overall Roll Length 3/4" (19.1mm) | | | Common Mandrel | |
| OD | Wall Thickness | | Inch | | Metric | | Expander Assembly | | Roll Set (3 per set) | | |
| | BWG | In | Metric | Min. | Max. | Min. | Max. | Flush | | | 1/8" Recess |
| 1/4" (6.4mm) | 18 | 0.049 | 1.24 | 0.149 | 0.173 | 3.78 | 4.39 | 23101 | 23101RA8 | 231R01-3 | 23M01 |
| | 19 | 0.042 | 1.07 | 0.161 | 0.185 | 4.09 | 4.71 | 23102 | 23102RA8 | | |
| | 20 | 0.035 | 0.89 | 0.173 | 0.200 | 4.39 | 5.08 | 23103 | 23103RA8 | 231R02-3 | 23M03 |
| | 21 | 0.032 | 0.81 | 0.181 | 0.208 | 4.60 | 5.29 | 23104 | 23104RA8 | | |
| | 22-23 | 0.028-0.025 | 0.71-0.64 | 0.188 | 0.219 | 4.78 | 5.56 | 23105 | 23105RA8 | 231R04-3 | 23M05 |
| | 24-25 | 0.022-0.020 | 0.56-0.51 | 0.198 | 0.229 | 5.03 | 5.82 | 23106 | 23106RA8 | | |
| | 26-30 | 0.018-0.012 | 0.46-0.31 | 0.205 | 0.236 | 5.21 | 6.00 | 23107 | 23107RA8 | 231R06-3 | 23M07 |

Mandrel drive square size is 1/4"





| 3 Roll Expanders | | | | | | | | | | | | | | | |
|------------------|----------------|-------------|-----------------|-------|-------|--------|--|-------------------|-------------|----------------------|---|-------------|----------------------|----------|----------------|
| Tube Size | | | Expansion Range | | | | Tube Sheet (Min/Max Reach) 1/4" - 1-1/4" (6.4 - 31.8mm) Overall Roll Length 3/4" (19.1mm) | | | | Tube Sheet (Min/Max Reach) 3/4" - 1-1/4" (19.1 - 31.8mm) Overall Roll Length 1-1/4" (31.8mm) | | | | Common Mandrel |
| OD | Wall Thickness | | | Inch | | Metric | | Expander Assembly | | Roll Set (3 per set) | Expander Assembly | | Roll Set (3 per set) | | |
| | BWG | In | Metric | Min. | Max. | Min. | Max. | Flush | 1/8" Recess | | Flush | 1/8" Recess | | | |
| 3/8" (9.5mm) | 14 | 0.083 | 2.11 | 0.203 | 0.235 | 5.16 | 5.96 | 23108 | 23108RA8 | 231R08-3 | - | - | - | 23M08 | |
| | 15 | 0.072 | 1.83 | 0.226 | 0.261 | 5.74 | 6.64 | 23109 | 23109RA8 | 231R09-3 | 23209 | 23209RA8 | 232R09-3 | 23M09 | |
| | 16 | 0.065 | 1.65 | 0.240 | 0.275 | 6.10 | 6.99 | 23110 | 23110RA8 | 231R10-3 | 23210 | 23210RA8 | 232R10-3 | | |
| | 17 | 0.058 | 1.47 | 0.254 | 0.291 | 6.45 | 7.38 | 23111 | 23111RA8 | | 231R12-3 | 23211 | | 23211RA8 | 232R12-3 |
| | 18 | 0.049 | 1.24 | 0.269 | 0.306 | 6.83 | 7.77 | 23112 | 23112RA8 | 231R13-3 | 23212 | 23212RA8 | 232R12-3 | 23M13 | |
| | 19 | 0.042 | 1.07 | 0.283 | 0.325 | 7.19 | 8.27 | 23113 | 23113RA8 | | 23213 | 23213RA8 | 232R13-3 | | |
| | 20 | 0.035 | 0.89 | 0.297 | 0.332 | 7.54 | 8.43 | 23114 | 23114RA8 | 231R15-3 | 23214 | 23214RA8 | 232R13-3 | 23M14 | |
| | 21 | 0.032 | 0.81 | 0.303 | 0.338 | 7.70 | 8.60 | 23115 | 23115RA8 | | 23215 | 23215RA8 | 232R15-3 | | |
| | 22-23 | 0.028-0.025 | 0.71-0.64 | 0.309 | 0.351 | 7.85 | 8.92 | 23116 | 23116RA8 | 231R16-3 | 23216 | 23216RA8 | 232R16-3 | 23M16 | |
| 24-26 | 0.022-0.018 | 0.56-0.46 | 0.321 | 0.363 | 8.15 | 9.21 | 23117 | 23117RA8 | 231R17-3 | 23217 | 23217RA8 | 232R17-3 | | | |

Mandrel drive square size is 1/4"



| 3 Roll Expanders - 3" Reach | | | | | | | | | | | | | | | |
|-----------------------------|----------------|-------------|-----------------|-------|-------|--------|--|-------------------|-------------|----------------------|---|-------------|----------------------|------------|----------------|
| Tube Size | | | Expansion Range | | | | Tube Sheet (Min/Max Reach) 1/4" - 3" (6.4 - 76.2mm) Overall Roll Length 3/4" (19.1mm) | | | | Tube Sheet (Min/Max Reach) 3/4" - 3" (19.1 - 76.2mm) Overall Roll Length 1-1/4" (31.8mm) | | | | Common Mandrel |
| OD | Wall Thickness | | | Inch | | Metric | | Expander Assembly | | Roll Set (3 per set) | Expander Assembly | | Roll Set (3 per set) | | |
| | BWG | In | Metric | Min. | Max. | Min. | Max. | Flush | 1/8" Recess | | Flush | 1/8" Recess | | | |
| 3/8" (9.5mm) | 15 | 0.072 | 1.83 | 0.226 | 0.261 | 5.74 | 6.64 | 23109-3 | 23109RA8-3 | 231R09-3 | 23209-3 | 23209RA8-3 | 232R09-3 | 23M09-3 | |
| | 16 | 0.065 | 1.65 | 0.240 | 0.275 | 6.10 | 6.99 | 23110-3 | 23110RA8-3 | 231R10-3 | 23210-3 | 23210RA8-3 | 232R10-3 | | |
| | 17 | 0.058 | 1.47 | 0.254 | 0.291 | 6.45 | 7.38 | 23111-3 | 23111RA8-3 | | 231R12-3 | 23211-3 | | 23211RA8-3 | 232R12-3 |
| | 18 | 0.049 | 1.24 | 0.269 | 0.306 | 6.83 | 7.77 | 23112-3 | 23112RA8-3 | 231R13-3 | 23212-3 | 23212RA8-3 | 232R12-3 | | |
| | 19 | 0.042 | 1.07 | 0.283 | 0.325 | 7.19 | 8.27 | 23113-3 | 23113RA8-3 | | 231R15-3 | 23213-3 | 23213RA8-3 | 232R13-3 | 23M13-3 |
| | 20 | 0.035 | 0.89 | 0.297 | 0.332 | 7.54 | 8.43 | 23114-3 | 23114RA8-3 | 23214-3 | | 23214RA8-3 | 232R13-3 | 23M14-3 | |
| | 21 | 0.032 | 0.81 | 0.303 | 0.338 | 7.70 | 8.60 | 23115-3 | 23115RA8-3 | 231R16-3 | 23215-3 | 23215RA8-3 | 232R15-3 | | 23M16-3 |
| | 22-23 | 0.028-0.025 | 0.71-0.64 | 0.309 | 0.351 | 7.85 | 8.92 | 23116-3 | 23116RA8-3 | 231R17-3 | 23216-3 | 23216RA8-3 | 232R16-3 | | |
| 24-26 | 0.022-0.018 | 0.56-0.46 | 0.321 | 0.363 | 8.15 | 9.21 | 23117-3 | 23117RA8-3 | 231R17-3 | 23217-3 | 23217RA8-3 | 232R17-3 | | | |

Mandrel drive square size is 1/4"



EXPANDING THICKER TUBE SHEETS IN HEAT EXCHANGERS

Heat exchangers are critical components in nuclear, petrochemical, and energy production, often operating under high pressure and corrosive environments. These demanding conditions frequently necessitate the use of thicker tube sheets to ensure longevity and structural integrity. While thicker tube sheets offer enhanced durability, they present unique challenges during the tube expansion process. This article provides a practical guide for operators and end-users on effectively expanding tubes into thicker tube sheets.

UNDERSTANDING THE CHALLENGES OF THICKER TUBE SHEETS

Tube sheet thickness is determined by several factors, including pressure requirements, thermal expansion considerations, corrosion allowance, and the necessary tube support. Industry standards like TEMA, API, and ASME provide specific guidelines for determining appropriate thicknesses. However, thicker tube sheets introduce complexities in the expansion process:

- **Increased Torque Requirements:** Expanding a thicker tube sheet requires long reach tooling, leading to significantly higher torque being applied. This increased torque can damage tooling through galling, pitting, or heat damage.
- **Uneven Expansion:** The stepped expansion process used with thicker tube sheets can result in uneven expansion if not performed carefully. Missed areas can create ridges or “catch points” in the tube, which become potential failure points during operation.
- **Work Hardening:** Overlapping expansion areas or multiple operations in the same location can lead to work hardening of the tube material. This can cause elongation and embrittlement, reducing the tube’s lifespan.
- **Increased Time and Labor:** Expanding thicker tube sheets can require 2 – 4Xs the labor compared to thinner sheets. This is due to the step rolling process, the increased number of tools needed, higher costs, and more extensive setup time for each expansion step.

THE EXPANSION PROCESS: A STEP-BY-STEP GUIDE

1. Choosing the Right Expander

Selecting the appropriate expander is crucial for successful tube expansion. Consider the following:

Tube and Tube Sheet Material Compatibility: If the tube and tube sheet materials have similar yield strengths, a multi-roll tool is generally recommended. For high-yield tube materials (e.g., super duplex stainless steel), a short-roll tool is often preferred due to the lower torque applied to the tool.

Double Radius Rolls: Using double radius rolls can minimize the formation of ridges during expansion, simplifying the overlap between expansion steps.

2. Step Rolling Technique

Step rolling is essential for achieving uniform expansion in thicker tube sheets. Follow these steps:

- **Expander Setup:** Begin with a long-reach expander. Set the tool so that the roll ends approximately $1/8''$ before the back face of the tube sheet. For the next step, use another long-reach tool and set it to overlap the previous expansion by about $1/4''$. Continue this process until you reach the operator side of the tube sheet.
- **Sequential Expansion:** Expand all tubes at the deepest setting first, working from the back face to the front face. Then, use the next shorter reach expander in the series and expand all tubes again. Repeat this process, progressively shortening the expander reach. Avoid using the long-reach tool for all expansions, as this increases the load on the tool and the risk of damage.
- **Tool Maintenance:** Maintain the tools in optimal condition. Keep them cool and clean, lubricate frequently, and remove any debris. Regularly swap out expanders to prevent overheating and premature wear.

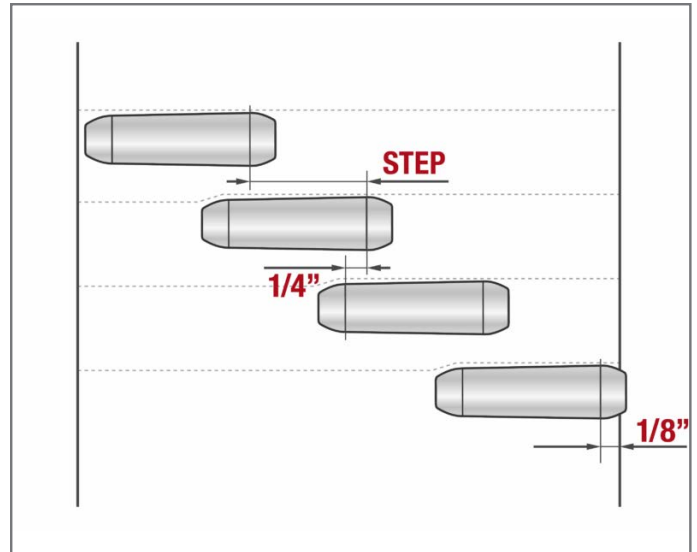

Figure 2. Step Rolling Process

BEST PRACTICES FOR EXPANDING THICKER TUBE SHEETS

- **Proper Lubrication:** Use a high-quality lubricant specifically designed for tube expansion to reduce friction and minimize tool wear.
- **Controlled Expansion:** Avoid over-expanding the tubes. Follow the manufacturer's recommendations for torque and expansion rates.
- **Inspection:** Thoroughly inspect each expanded tube for any defects, such as cracks, ridges, or uneven expansion.
- **Training:** Ensure that operators are adequately trained on the proper techniques for expanding tubes in thicker tube sheets.

CONCLUSION

Expanding tubes into thicker tube sheets requires careful planning, the right tools, and a thorough understanding of the challenges involved. By following the guidelines outlined in this article, operators can achieve consistent, high-quality expansions, ensuring the long-term reliability and performance of heat exchangers in demanding applications. Remember to always consult relevant industry standards (TEMA, API, ASME) for specific requirements and best practices.



Figure 1. SA350 LF2 Tube Sheet,
Image provided by SHECO - Southern Heat Exchanger

24 SERIES

Heat Exchanger & Condenser Expanders

Tube Size

- 0.500" – 2.000" OD
- 12.7 mm – 50.8 mm OD



PROVEN TOOL LIFE FROM THE INVENTOR OF THE TUBE EXPANDER

Elliott's 24 Series Condenser Expanders are ideal for expanding tubes in chillers, heat exchangers, feedwater heaters, fin fan coolers, and surface condensers.

24 Series Expanders are available in both standard and longer reaches. 4 and 5 roll expanders are also available for rolling thin wall stainless steel and titanium tubes.

24 Series Offerings:

| | |
|--|----|
| 3 Roll 4" Reach Expanders | 46 |
| 3 Roll 8" Reach Expanders | 48 |
| 3 Roll 12" Reach Expanders | 50 |
| 4 & 5 Roll Expanders..... | 52 |
| 4 & 5 Roll Expanders with Nylon Pilot..... | 54 |
| 5 Roll 8" & 12" Reach Expanders..... | 55 |

Spares:

- Collars **see page 45**
- Mandrels
- Roll Sets

Accessories:





- Lubricant **see page 19**
- Rolling Motors and Torque Controls **see page 62**

“ Elliott's 24 Series Tube Expanders have excellent tool life. They held consistent rolled ID numbers and are easy to adjust. I'm purchasing more immediately.

Jim Damon
Lean Manufacturing Engineer



Elliott offers several types of collars for the 24 Series Condenser Expanders to accommodate all of your tube expansion job requirements.

| Application | Collar Type | Other Information | |
|---|--------------------|---|---|
| Roll tubes flush with tube sheet. | Flush Collar | This is the standard collar furnished with the 24 Series. |  |
| Roll tubes that extend a uniform distance beyond tube sheet. | Recessed Collar | Elliott will recess collars to your requirements in depth increments of 1/64" each. |  |
| Roll tubes that extend at irregular distance beyond tube sheet. | Telescoping Collar | The end of the collar butts against the sheet thus maintaining a constant depth roll in the sheet without thrusting against end of tube. |  |
| Roll thin wall tubes flush with tube sheet. | Thin Wall Collar | Thin wall insert fits inside of the thin wall collar housing to prevent the thin wall tube from being drawn into the collar during expansion. |  |

Custom collars available upon request.

ALL NEW JAM NUT STYLE COLLARS

Elliott's standard collar will now feature a Jam Nut Style design. Optional collar kits are available for purchase during the transition.



24 SERIES

3 Roll Expanders

Tube Size

- 0.500" – 2.000" OD
- 12.7 mm – 50.8 mm OD



| 3 Roll Expanders | | | | | | | | | | | | | | | |
|------------------|----------------|-------------|-----------------|-------|--------|------|---|-------------|-------------------------|-------------------|---|-------------------------|-------------|----------|----------------|
| Tube Size | | | Expansion Range | | | | Tube Sheet (Min/Max Reach) 0.500"–3.830" (12.7-97.3mm) Overall Roll Length 1-5/8" (41.3mm) **Overall Roll Length 1-1/2" (38.1mm) | | | | Tube Sheet (Min/Max Reach) 1.250" - 4.200" (31.8-106.7mm) Overall Roll Length 2-3/8" (60.3mm) ***Overall Roll Length 2-1/4" (57.15mm) | | | | Common Mandrel |
| | | | | | | | Expander Assembly | | Roll Set (3 per set) | Expander Assembly | | Roll Set (3 per set) | | | |
| OD | Wall Thickness | | Inch | | Metric | | Flush | 1/8" Recess | | Flush | 1/8" Recess | | | | |
| | BWG | In | Metric | Min. | Max. | Min. | | | Max. | | | | | | |
| 1/2" (12.7mm) | 13 | 0.095 | 2.41 | 0.305 | 0.340 | 7.7 | 8.6 | 24121 | 24121RB8 | 241R21-3** | 24221 | 24221RB8 | 242R21-3*** | 24M21 | |
| | 14 | 0.083 | 2.11 | 0.324 | 0.366 | 8.4 | 9.3 | 24122 | 24122RB8 | 241R22-3** | 24222 | 24222RB8 | 242R22-3*** | 24M22 | |
| | 15 | 0.072 | 1.83 | 0.346 | 0.386 | 8.8 | 9.7 | 24123 | 24123RA8 | | 24223 | 24223RA8 | 24M23 | | |
| | 16-17 | 0.065-0.085 | 1.65-1.47 | 0.367 | 0.410 | 9.1 | 10.4 | 24124 | 24124RA8 | 241R24-3** | 24224 | 24224RA8 | 242R24-3*** | 24M24 | |
| | 18 | 0.049 | 1.24 | 0.392 | 0.447 | 10.0 | 11.3 | 24125 | 24125RA8 | 241R25-3** | 24225 | 24225RA8 | 242R25-3*** | 24M25 | |
| | 19-20 | 0.042-0.035 | 1.07-0.89 | 0.402 | 0.457 | 10.2 | 11.6 | 24126 | 24126RA8 | 241R26-3** | 24226 | 24226RA8 | 242R26-3*** | | |
| | 21-22 | 0.035-0.028 | 0.81-0.71 | 0.425 | 0.482 | 10.8 | 12.3 | 24127 | 24127RA8 | 241R27-3** | 24227 | 24227RB8 | 242R27-3*** | 24M27 | |
| 5/8" (15.9mm) | 12 | 0.109 | 2.77 | 0.392 | 0.447 | 10.0 | 11.3 | 24125 | 24125RB8 | 241R25-3** | 24225 | 24225RB8 | 242R25-3*** | 24M25 | |
| | 13 | 0.095 | 2.41 | 0.425 | 0.482 | 10.8 | 12.3 | 24127 | 24127RB8 | 241R27-3** | 24227 | 24227RB8 | 242R27-3*** | 24M27 | |
| | 14 | 0.083 | 2.11 | 0.449 | 0.506 | 11.4 | 12.8 | 24128 | 24128RA8 | 241R28-3 | 24228 | 24228RA8 | 242R28-3 | 24M28 | |
| | 15 | 0.072 | 1.83 | 0.471 | 0.524 | 12.0 | 13.3 | 24129 | 24129RA8 | 241R29-3 | 24229 | 24229RA8 | 242R29-3 | 24M29 | |
| | 16 | 0.065 | 1.65 | 0.485 | 0.538 | 12.3 | 13.7 | 24129B | 24129BRA8 | | 24229B | 24229BRA8 | | | |
| | 17 | 0.058 | 1.47 | 0.499 | 0.564 | 12.7 | 14.3 | 24130 | 24130RA8 | 241R30-3 | 24230 | 24230RA8 | 242R30-3 | 24M30 | |
| | 18-19 | 0.049-0.042 | 1.24-1.07 | 0.517 | 0.584 | 13.1 | 14.8 | 24131 | 24131RA8 | 241R31-3 | 24231 | 24231RA8 | 242R31-3 | 24M31 | |
| 20-22 | 0.035-0.028 | 0.89-0.71 | 0.540 | 0.609 | 13.7 | 15.5 | 24132 | 24132RA8 | 241R32-3 | 24232 | 24232RA8 | 242R32-3 | 24M32 | | |
| 3/4" (19.1mm) | 10 | 0.134 | 3.40 | 0.471 | 0.538 | 12.0 | 13.7 | 24129 | 24129RB8 | 241R29-3 | 24229 | 24229RB8 | 242R29-3 | 24M29 | |
| | 11 | 0.120 | 3.05 | 0.499 | 0.564 | 12.7 | 14.3 | 24130 | 24130RB8 | 241R30-3 | 24230 | 24230RB8 | 242R30-3 | 24M30 | |
| | 12 | 0.109 | 2.77 | 0.517 | 0.584 | 13.1 | 14.8 | 24131 | 24131RB8 | 241R31-3 | 24231 | 24231RB8 | 242R31-3 | 24M31 | |
| | 13 | 0.095 | 2.41 | 0.540 | 0.609 | 13.7 | 15.5 | 24132 | 24132RB8 | 241R32-3 | 24232 | 24232RB8 | 242R32-3 | 24M32 | |
| | 14 | 0.083 | 2.11 | 0.562 | 0.631 | 14.3 | 16.0 | 24133 | 24133RA8 | 241R33-3 | 24233 | 24233RA8 | 242R33-3 | | |
| | 15-16 | 0.072-0.065 | 1.83-1.65 | 0.592 | 0.672 | 15.0 | 17.1 | 24134 | 24134RA8 | 241R34-3 | 24234 | 24234RA8 | 242R34-3 | 24M34 | |
| | 17-18 | 0.058-0.049 | 1.47-1.24 | 0.620 | 0.697 | 15.7 | 17.7 | 24135 | 24135RA8 | 241R35-3 | 24235 | 24235RA8 | 242R35-3 | 24M35 | |
| 19-22 | 0.042-0.028 | 1.07-0.71 | 0.641 | 0.731 | 16.3 | 18.6 | 24136 | 24136RA8 | 241R36-3 | 24236 | 24236RA8 | 242R36-3 | 24M36 | | |
| 7/8" (22.2mm) | 10 | 0.134 | 3.40 | 0.592 | 0.672 | 15.0 | 17.1 | 24134 | 24134RB8 | 241R34-3 | 24234 | 24234RB8 | 242R34-3 | 24M34 | |
| | 11 | 0.120 | 3.05 | 0.620 | 0.697 | 15.7 | 17.7 | 24135 | 24135RB8 | 241R35-3 | 24235 | 24235RB8 | 242R35-3 | 24M35 | |
| | 12 | 0.109 | 2.77 | 0.641 | 0.731 | 16.3 | 18.6 | 24136 | 24136RB8 | 241R36-3 | 24236 | 24236RB8 | 242R36-3 | 24M36 | |
| | 13 | 0.095 | 2.41 | 0.655 | 0.745 | 16.6 | 18.9 | 24138 | 24138RA8 | 241R38-3 | 24238 | 24238RA8 | 242R38-3 | | |
| | 14 | 0.083 | 2.11 | 0.675 | 0.765 | 17.1 | 19.4 | 24139 | 24139RA8 | 241R39-3 | 24239 | 24239RA8 | 242R39-3 | 24M40 | |
| | 15-16 | 0.072-0.065 | 1.83-1.65 | 0.715 | 0.800 | 18.2 | 20.3 | 24140 | 24140RA8 | | 24240 | 24240RA8 | | | |
| | 17-19 | 0.058-0.049 | 1.47-1.07 | 0.743 | 0.828 | 18.9 | 21.0 | 24141 | 24141RA8 | 241R41-3 | 24241 | 24241RA8 | 242R41-3 | 24M42 | |
| 20-22 | 0.035-0.028 | 0.89-0.71 | 0.795 | 0.865 | 20.2 | 22.0 | 24142 | 24142RA8 | 241R42-3 | 24242 | 24242RA8 | 242R42-3 | 24M42 | | |
| 1" (25.4mm) | 8 | 0.165 | 4.19 | 0.655 | 0.745 | 16.6 | 18.9 | 24138 | 24138RB8 | 241R38-3 | 24238 | 24238RB8 | 242R38-3 | 24M36 | |
| | 9 | 0.148 | 3.76 | 0.675 | 0.765 | 17.1 | 19.4 | 24139 | 24139RB8 | 241R39-3 | 24239 | 24239RB8 | 242R39-3 | | |
| | 10 | 0.134 | 3.40 | 0.715 | 0.800 | 18.2 | 20.3 | 24140 | 24140RB8 | | 24240 | 24240RB8 | | 242R41-3 | 24M40 |
| | 11 | 0.120 | 3.05 | 0.743 | 0.828 | 18.9 | 21.0 | 24141 | 24141RB8 | 241R41-3 | 24241 | 24241RB8 | | | |
| | 12-13 | 0.109-0.095 | 2.77-2.41 | 0.769 | 0.866 | 19.5 | 22.0 | 24143 | 24143RA8 | 241R42-3 | 24243 | 24243RA8 | 242R42-3 | 24M43 | |
| | 14 | 0.083 | 2.11 | 0.799 | 0.896 | 20.3 | 22.7 | 24144 | 24144RA8 | 241R44-3 | 24244 | 24244RA8 | 242R44-3 | | |
| | 15-16 | 0.072-0.065 | 1.83-1.65 | 0.841 | 0.922 | 21.4 | 23.4 | 24145 | 24145RA8 | | 24245 | 24245RA8 | | 24M45* | |
| 17-19 | 0.058-0.042 | 1.47-1.07 | 0.872 | 0.968 | 22.1 | 24.6 | 24146 | 24146RA8 | 241R46-3 | 24246 | 24246RA8 | 242R46-3 | 24M46* | | |
| 20-22 | 0.035-0.028 | 0.89-0.71 | 0.894 | 0.990 | 22.7 | 25.2 | 24147 | 24147RA8 | 241R47-3 | 24247 | 24247RA8 | 242R47-3 | | | |



Mandrel drive square size is 3/8"

*Mandrel drive square size is 1/2"

**Mandrel drive square size is 3/4"

24 SERIES

3 Roll Expanders

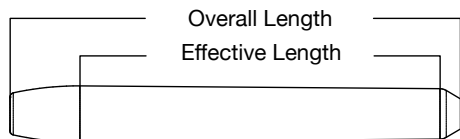

| Roll Part Number | Overall Roll Length | Effective Roll Length |
|------------------|---------------------|-----------------------|
| 241R21 - 241R27 | 1.500" (38.1mm) | 1.187" (30.1mm) |
| 241R28 - 241R42 | 1.625" (41.3mm) | 1.301" (33.0mm) |
| 241R43 - 241R69 | | 1.239" (31.5mm) |
| 242R21 - 242R27 | 2.250" (57.2mm) | 1.937" (49.2mm) |
| 242R28 - 242R42 | 2.365" (60.3mm) | 2.051" (52.1mm) |
| 242R43 - 242R69 | | 1.989" (50.5mm) |

| 3 Roll Expanders | | | | | | | | | | | | | | |
|--------------------|----------------|-------------|-----------------|-------|-------|--------|---|-------------------|-------------|----------------------|---|-------------|----------------------|----------------|
| Tube Size | | | Expansion Range | | | | Tube Sheet (Min/Max Reach) 0.500"-3.830" (12.7-97.3mm) Overall Roll Length 1-5/8" (41.3mm) **Overall Roll Length 1-1/2" (38.1mm) | | | | Tube Sheet (Min/Max Reach) 1.250" - 4.200" (31.8-106.7mm) Overall Roll Length 2-3/8" (60.3mm) ***Overall Roll Length 2-1/4" (57.15mm) | | | Common Mandrel |
| OD | Wall Thickness | | | Inch | | Metric | | Expander Assembly | | Roll Set (3 per set) | Expander Assembly | | Roll Set (3 per set) | |
| | BWG | In | Metric | Min. | Max. | Min. | Max. | Flush | 1/8" Recess | | Flush | 1/8" Recess | | |
| 1-1/8" (28.6mm) | 8 | 0.165 | 4.19 | 0.769 | 0.866 | 19.5 | 22.0 | 24143 | 24143RB8 | 241R42-3 | 24243 | 24243RB8 | 242R42-3 | 24M43 |
| | 9 | 0.148 | 3.76 | 0.799 | 0.896 | 20.3 | 22.7 | 24144 | 24144RB8 | 241R44-3 | 24244 | 24244RB8 | 242R44-3 | |
| | 10 | 0.134 | 3.40 | 0.841 | 0.922 | 21.4 | 23.4 | 24145 | 24145RB8 | | 241R46-3 | 24245 | | 24245RB8 |
| | 11-12 | 0.120-0.109 | 3.05-2.77 | 0.872 | 0.968 | 22.1 | 24.6 | 24146 | 24146RB8 | 241R47-3 | | 24246 | 24246RB8 | 242R47-3 |
| | 13 | 0.095 | 2.41 | 0.894 | 1.009 | 22.7 | 25.6 | 24149 | 24149RA8 | | 241R50-3 | 24249 | 24249RA8 | |
| | 14-15 | 0.083-0.072 | 2.11-1.83 | 0.924 | 1.039 | 23.5 | 26.4 | 24150 | 24150RA8 | 241R52-3 | | 24250 | 24250RA8 | 242R52-3 |
| | 16-18 | 0.065-0.049 | 1.65-1.24 | 0.978 | 1.078 | 24.8 | 27.4 | 24151 | 24151RA8 | | 241R53-3 | 24251 | 24251RA8 | |
| 19-22 | 0.042-0.028 | 1.07-0.71 | 1.016 | 1.116 | 25.8 | 28.4 | 24152 | 24152RA8 | 241R55-3 | 24252 | | 24252RA8 | 242R55-3 | 24M58* |
| 1-1/4" (31.8mm) | 8 | 0.165 | 4.19 | 0.894 | 1.009 | 22.7 | 25.6 | 24149 | | 24149RB8 | 241R47-3 | 24249 | | |
| | 9 | 0.148 | 3.76 | 0.924 | 1.039 | 23.5 | 26.4 | 24150 | 24150RB8 | 241R50-3 | 24250 | 24250RB8 | 242R50-3 | 24M53* |
| | 10-11 | 0.134-0.120 | 3.40-3.05 | 0.962 | 1.083 | 24.4 | 27.5 | 24153 | 24153RA8 | 241R53-3 | 24253 | 24253RA8 | 242R53-3 | |
| | 12-13 | 0.109-0.095 | 2.77-2.41 | 1.012 | 1.128 | 25.7 | 28.7 | 24155 | 24155RA8 | 241R52-3 | 24255 | 24255RA8 | 242R52-3 | 24M56* |
| | 14-17 | 0.083-0.058 | 2.11-1.47 | 1.066 | 1.195 | 27.1 | 30.3 | 24156 | 24156RA8 | 241R56-3 | 24256 | 24256RA8 | 242R56-3 | |
| 18-22 | 0.049-0.028 | 1.24-0.71 | 1.112 | 1.240 | 28.2 | 31.5 | 24157 | 24157RA8 | 241R57-3 | 24257 | 24257RA8 | 242R57-3 | 24M59* | |
| 1-3/8" (34.9mm) | 8 | 0.165 | 4.19 | 1.012 | 1.128 | 25.7 | 28.7 | 24155 | 24155RB8 | 241R52-3 | 24255 | 24255RB8 | | 242R52-3 |
| | 9-10 | 0.148-0.134 | 3.76-3.40 | 1.066 | 1.195 | 27.1 | 30.3 | 24156 | 24156RB8 | 241R56-3 | 24256 | 24256RB8 | 242R56-3 | 24M56* |
| | 11 | 0.120 | 3.05 | 1.115 | 1.218 | 28.3 | 30.9 | 24158 | 24158RA8 | 241R58-3 | 24258 | 24258RA8 | 242R58-3 | |
| | 12-13 | 0.109-0.095 | 2.77-2.41 | 1.127 | 1.263 | 28.6 | 32.1 | 24159 | 24159RA8 | 241R57-3 | 24259 | 24259RA8 | 242R57-3 | 24M60* |
| | 14-17 | 0.083-0.058 | 2.11-1.47 | 1.180 | 1.322 | 30.0 | 33.6 | 24160 | 24160RA8 | 241R60-3 | 24260 | 24260RA8 | 242R60-3 | |
| 18-22 | 0.049-0.028 | 1.24-0.71 | 1.224 | 1.365 | 31.1 | 34.7 | 24161 | 24161RA8 | 241R61-3 | 24261 | 24261RA8 | 242R61-3 | 24M66** | |
| 1-1/2" (38.1mm) | 8 | 0.165 | 4.19 | 1.127 | 1.263 | 28.6 | 32.1 | 24159 | 24159RB8 | 241R57-3 | 24259 | 24259RB8 | | 242R57-3 |
| | 9-10 | 0.148-0.134 | 3.76-3.40 | 1.180 | 1.322 | 30.0 | 33.6 | 24160 | 24160RB8 | 241R60-3 | 24260 | 24260RB8 | 242R60-3 | 24M60* |
| | 11-12 | 0.120-0.109 | 3.05-2.77 | 1.224 | 1.365 | 31.1 | 34.7 | 24161 | 24161RB8 | 241R61-3 | 24261 | 24261RB8 | 242R61-3 | |
| | 13-14 | 0.095-0.083 | 2.41-2.11 | 1.285 | 1.415 | 32.6 | 35.9 | 24163 | 24163RA8 | | 241R64-3 | 24264 | | 24264RA8 |
| | 15-17 | 0.072-0.058 | 1.83-1.47 | 1.325 | 1.455 | 33.7 | 36.9 | 24164 | 24164RA8 | 241R65-3 | 24265 | 24265RA8 | 242R65-3 | 24M67** |
| 18-22 | 0.049-0.028 | 1.24-0.71 | 1.361 | 1.490 | 34.6 | 37.9 | 24165 | 24165RA8 | 241R66-3 | 24266 | 24266RA8 | 242R66-3 | 24M69** | |
| 2" (50.8mm) | 13-16 | 0.095-0.065 | 2.41-1.65 | 1.750 | 1.952 | 44.0 | 49.6 | 24167 | 24167RA8 | 241R67-3 | 24267 | 24267RA8 | | 242R67-3 |
| | 17-22 | 0.058-0.028 | 1.47-0.71 | 1.848 | 1.990 | 46.9 | 50.5 | 24169 | 24169RA8 | | 24269 | 24169RA8 | 24269 | |

Mandrel drive square size is 3/8"

*Mandrel drive square size is 1/2"

**Mandrel drive square size is 3/4"



24 SERIES

3 Roll Expanders - 8" Reach

Tube Size

- 0.500" to 2.000" OD
- (12.7 to 50.8mm) OD



3 Roll Expanders

| Tube Size | | Expansion Range | | Tube Sheet (Min/Max Reach) 0.500" - 7.830" (12.7-198.9mm) Overall Roll Length 1-5/8" (41.3mm) **Overall Roll Length 1-1/2" (38.1mm) | | | | Tube Sheet (Min/Max Reach) 1.250" - 8.200" (31.8-208.3mm) Overall Roll Length 2-3/8" (60.3mm) ***Overall Roll Length 2-1/4" (57.15mm) | | | | Common Mandrel | | |
|------------------|----------------|-----------------|-----------|--|--------|------|-------------------|--|-------------------------|-------------------|------------|----------------|-------------------------|----------|
| OD | Wall Thickness | | Inch | | Metric | | Expander Assembly | | Roll Set (3 per set) | Expander Assembly | | | Roll Set (3 per set) | |
| | BWG | In | Metric | Min. | Max. | Min. | Max. | Flush | | 1/8" Recess | Flush | 1/8" Recess | | |
| 1/2" (12.7mm) | 13 | 0.095 | 2.41 | 0.305 | 0.340 | 7.7 | 8.6 | 24121-8 | 24121RB8-8 | 241R21-3** | 24221-8 | 24221RB8-8 | 242R21-3*** | 24M21-8 |
| | 14 | 0.083 | 2.11 | 0.324 | 0.366 | 8.4 | 9.3 | 24122-8 | 24122RB8-8 | 241R22-3** | 24222-8 | 24222RB8-8 | 242R22-3*** | 24M22-8 |
| | 15 | 0.072 | 1.83 | 0.346 | 0.386 | 8.8 | 9.7 | 24123-8 | 24123RA8-8 | | 24223-8 | 24223RA8-8 | | 24M23-8 |
| | 16-17 | 0.065-0.085 | 1.65-1.47 | 0.367 | 0.410 | 9.1 | 10.4 | 24124-8 | 24124RA8-8 | 241R24-3** | 24224-8 | 24224RA8-8 | 242R24-3*** | 24M24-8 |
| | 18 | 0.049 | 1.24 | 0.392 | 0.447 | 10.0 | 11.3 | 24125-8 | 24125RA8-8 | 241R25-3** | 24225-8 | 24225RA8-8 | 242R25-3*** | 24M25-8 |
| | 19-20 | 0.042-0.035 | 1.07-0.89 | 0.402 | 0.457 | 10.2 | 11.6 | 24126-8 | 24126RA8-8 | 241R26-3** | 24226-8 | 24226RA8-8 | 242R26-3*** | |
| | 21-22 | 0.035-0.028 | 0.81-0.71 | 0.425 | 0.482 | 10.8 | 12.3 | 24127-8 | 24127RA8-8 | 241R27-3** | 24227-8 | 24227RA8-8 | 242R27-3*** | 24M27-8 |
| 5/8" (15.9mm) | 12 | 0.109 | 2.77 | 0.392 | 0.447 | 10.0 | 11.3 | 24125-8 | 24125RB8-8 | 241R25-3** | 24225-8 | 24225RB8-8 | 242R25-3*** | 24M25-8 |
| | 13 | 0.095 | 2.41 | 0.425 | 0.482 | 10.8 | 12.3 | 24127-8 | 24127RB8-8 | 241R27-3** | 24227-8 | 24227RB8-8 | 242R27-3*** | 24M27-8 |
| | 14 | 0.083 | 2.11 | 0.449 | 0.506 | 11.4 | 12.8 | 24128-8 | 24128RA8-8 | 241R28-3 | 24228-8 | 24228RA8-8 | 242R28-3 | 24M28-8 |
| | 15 | 0.072 | 1.83 | 0.471 | 0.524 | 12.0 | 13.3 | 24129-8 | 24129RA8-8 | 241R29-3 | 24229-8 | 24229RA8-8 | 242R29-3 | 24M29-8 |
| | 16 | 0.065 | 1.65 | 0.485 | 0.538 | 12.3 | 13.7 | 24129B-8 | 24129BRA8-8 | | 24229B-8 | 24229BRA8-8 | | |
| | 17 | 0.058 | 1.47 | 0.499 | 0.564 | 12.7 | 14.3 | 24130-8 | 24130RA8-8 | 241R30-3 | 24230-8 | 24230RA8-8 | 242R30-3 | 24M30-8 |
| | 18-19 | 0.049-0.042 | 1.24-1.07 | 0.517 | 0.584 | 13.1 | 14.8 | 24131-8 | 24131RA8-8 | 241R31-3 | 24231-8 | 24231RA8-8 | 242R31-3 | 24M31-8 |
| 20-22 | 0.035-0.028 | 0.89-0.71 | 0.540 | 0.609 | 13.7 | 15.5 | 24132-8 | 24132RA8-8 | 241R32-3 | 24232-8 | 24232RA8-8 | 242R32-3 | 24M32-8 | |
| 3/4" (19.1mm) | 10 | 0.134 | 3.40 | 0.471 | 0.538 | 12.0 | 13.7 | 24129-8 | 24129RB8-8 | 241R29-3 | 24229-8 | 24229RB8-8 | 242R29-3 | 24M29-8 |
| | 11 | 0.120 | 3.05 | 0.499 | 0.564 | 12.7 | 14.3 | 24130-8 | 24130RB8-8 | 241R30-3 | 24230-8 | 24230RB8-8 | 242R30-3 | 24M30-8 |
| | 12 | 0.109 | 2.77 | 0.517 | 0.584 | 13.1 | 14.8 | 24131-8 | 24131RB8-8 | 241R31-3 | 24231-8 | 24231RB8-8 | 242R31-3 | 24M31-8 |
| | 13 | 0.095 | 2.41 | 0.540 | 0.609 | 13.7 | 15.5 | 24132-8 | 24132RB8-8 | 241R32-3 | 24232-8 | 24232RB8-8 | 242R32-3 | 24M32-8 |
| | 14 | 0.083 | 2.11 | 0.562 | 0.631 | 14.3 | 16.0 | 24133-8 | 24133RA8-8 | 241R33-3 | 24233-8 | 24233RA8-8 | 242R33-3 | |
| | 15-16 | 0.072-0.065 | 1.83-1.65 | 0.592 | 0.672 | 15.0 | 17.1 | 24134-8 | 24134RA8-8 | 241R34-3 | 24234-8 | 24234RA8-8 | 242R34-3 | 24M34-8 |
| | 17-18 | 0.058-0.049 | 1.47-1.24 | 0.620 | 0.697 | 15.7 | 17.7 | 24135-8 | 24135RA8-8 | 241R35-3 | 24235-8 | 24235RA8-8 | 242R35-3 | 24M35-8 |
| 19-22 | 0.042-0.028 | 1.07-0.71 | 0.641 | 0.731 | 16.3 | 18.6 | 24136-8 | 24136RA8-8 | 241R36-3 | 24236-8 | 24236RA8-8 | 242R36-3 | 24M36-8 | |
| 7/8" (22.2mm) | 10 | 0.134 | 3.40 | 0.592 | 0.672 | 15.0 | 17.1 | 24134-8 | 24134RB8-8 | 241R34-3 | 24234-8 | 24234RB8-8 | 242R34-3 | 24M34-8 |
| | 11 | 0.120 | 3.05 | 0.620 | 0.697 | 15.7 | 17.7 | 24135-8 | 24135RB8-8 | 241R35-3 | 24235-8 | 24235RB8-8 | 242R35-3 | 24M35-8 |
| | 12 | 0.109 | 2.77 | 0.641 | 0.731 | 16.3 | 18.6 | 24136-8 | 24136RB8-8 | 241R36-3 | 24236-8 | 24236RB8-8 | 242R36-3 | 24M36-8 |
| | 13 | 0.095 | 2.41 | 0.655 | 0.745 | 16.6 | 18.9 | 24138-8 | 24138RA8-8 | 241R38-3 | 24238-8 | 24238RA8-8 | 242R38-3 | |
| | 14 | 0.083 | 2.11 | 0.675 | 0.765 | 17.1 | 19.4 | 24139-8 | 24139RA8-8 | 241R39-3 | 24239-8 | 24239RA8-8 | 242R39-3 | |
| | 15-16 | 0.072-0.065 | 1.83-1.65 | 0.715 | 0.800 | 18.2 | 20.3 | 24140-8 | 24140RA8-8 | | 24240-8 | 24240RA8-8 | | |
| | 17-19 | 0.058-0.049 | 1.47-1.07 | 0.743 | 0.828 | 18.9 | 21.0 | 24141-8 | 24141RA8-8 | 241R41-3 | 24241-8 | 24241RA8-8 | 242R41-3 | 24M40-8 |
| 20-22 | 0.035-0.028 | 0.89-0.71 | 0.795 | 0.865 | 20.2 | 22.0 | 24142-8 | 24142RA8-8 | 241R42-3 | 24242-8 | 24242RA8-8 | 242R42-3 | | |
| 1" (25.4mm) | 8 | 0.165 | 4.19 | 0.655 | 0.745 | 16.6 | 18.9 | 24138-8 | 24138RB8-8 | 241R38-3 | 24238-8 | 24238RB8-8 | 242R38-3 | 24M36-8 |
| | 9 | 0.148 | 3.76 | 0.675 | 0.765 | 17.1 | 19.4 | 24139-8 | 24139RB8-8 | 241R39-3 | 24239-8 | 24239RB8-8 | 242R39-3 | |
| | 10 | 0.134 | 3.40 | 0.715 | 0.800 | 18.2 | 20.3 | 24140-8 | 24140RB8-8 | | 24240-8 | 24240RB8-8 | | 24M40-8 |
| | 11 | 0.120 | 3.05 | 0.743 | 0.828 | 18.9 | 21.0 | 24141-8 | 24141RB8-8 | 241R41-3 | 24241-8 | 24241RB8-8 | 242R41-3 | |
| | 12-13 | 0.109-0.095 | 2.77-2.41 | 0.769 | 0.866 | 19.5 | 22.0 | 24143-8 | 24143RA8-8 | 241R42-3 | 24243-8 | 24243RA8-8 | 242R42-3 | 24M43-8 |
| | 14 | 0.083 | 2.11 | 0.799 | 0.896 | 20.3 | 22.7 | 24144-8 | 24144RA8-8 | 241R44-3 | 24244-8 | 24244RA8-8 | 242R44-3 | |
| | 15-16 | 0.072-0.065 | 1.83-1.65 | 0.841 | 0.922 | 21.4 | 23.4 | 24145-8 | 24145RA8-8 | | 24245-8 | 24245RA8-8 | | 24M45-8* |
| | 17-19 | 0.058-0.042 | 1.47-1.07 | 0.872 | 0.968 | 22.1 | 24.6 | 24146-8 | 24146RA8-8 | 241R46-3 | 24246-8 | 24246RA8-8 | 242R46-3 | |
| 20-22 | 0.035-0.028 | 0.89-0.71 | 0.894 | 0.990 | 22.7 | 25.2 | 24147-8 | 24147RA8-8 | 241R47-3 | 24247-8 | 24247RA8-8 | 242R47-3 | | |



Mandrel drive square size is 3/8". *Mandrel drive square size is 1/2". **Mandrel drive square size is 3/4".

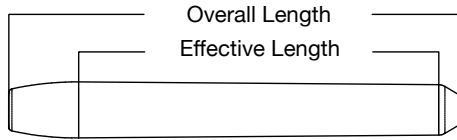

| Roll Part Number | Overall Roll Length | Effective Roll Length |
|------------------|---------------------|-----------------------|
| 241R21 - 241R27 | 1.500" (38.1mm) | 1.187" (30.1mm) |
| 241R28 - 241R42 | 1.625" (41.3mm) | 1.301" (33.0mm) |
| 241R43 - 241R69 | | 1.239" (31.5mm) |
| 242R21 - 242R27 | 2.250" (57.2mm) | 1.937" (49.2mm) |
| 242R28 - 242R42 | 2.365" (60.3mm) | 2.051" (52.1mm) |
| 242R43 - 242R69 | | 1.989" (50.5mm) |

| 3 Roll Expanders | | | | | | | | | | | | | | | | |
|--------------------|----------------|-------------|-----------|-----------------|-------|--------|------|--|-------------|-------------------------------------|-------------------------|--|----------|--------------------------------------|-----------|----------------|
| Tube Size | | | | Expansion Range | | | | Tube Sheet (Min/Max Reach) 0.500" - 7.830" (12.7-198.9mm) | | | | Tube Sheet (Min/Max Reach) 1.250" - 8.200" (31.8-208.3mm) | | | | Common Mandrel |
| | | | | | | | | Overall Roll Length 1-5/8" (41.3mm) | | Overall Roll Length 1-1/2" (38.1mm) | | Overall Roll Length 2-3/8" (60.3mm) | | Overall Roll Length 2-1/4" (57.15mm) | | |
| OD | Wall Thickness | | | Inch | | Metric | | Expander Assembly | | | Roll Set (3 per set) | Expander Assembly | | Roll Set (3 per set) | | |
| | BWG | In | Metric | Min. | Max. | Min. | Max. | Flush | 1/8" Recess | Flush | | 1/8" Recess | | | | |
| 1-1/8" (28.6mm) | 8 | 0.165 | 4.19 | 0.769 | 0.866 | 19.5 | 22.0 | 24143-8 | 24143RB8-8 | 241R42-3 | 24243-8 | 24243RB8-8 | 242R42-3 | 24M43-8 | | |
| | 9 | 0.148 | 3.76 | 0.799 | 0.896 | 20.3 | 22.7 | 24144-8 | 24144RB8-8 | 241R44-3 | 24244-8 | 24244RB8-8 | 242R44-3 | | | |
| | 10 | 0.134 | 3.40 | 0.841 | 0.922 | 21.4 | 23.4 | 24145-8 | 24145RB8-8 | | 24245-8 | 24245RB8-8 | | 242R45-8 | | |
| | 11-12 | 0.120-0.109 | 3.05-2.77 | 0.872 | 0.968 | 22.1 | 24.6 | 24146-8 | 24146RB8-8 | 241R46-3 | 24246-8 | 24246RB8-8 | 242R46-3 | | 24M46-8* | |
| | 13 | 0.095 | 2.41 | 0.894 | 1.009 | 22.7 | 25.6 | 24149-8 | 24149RA8-8 | 241R47-3 | 24249-8 | 24249RA8-8 | 242R47-3 | 24M49-8* | | |
| | 14-15 | 0.083-0.072 | 2.11-1.83 | 0.924 | 1.039 | 23.5 | 26.4 | 24150-8 | 24150RA8-8 | 241R50-3 | 24250-8 | 24250RA8-8 | 242R50-3 | | | |
| | 16-18 | 0.065-0.049 | 1.65-1.24 | 0.978 | 1.078 | 24.8 | 27.4 | 24151-8 | 24151RA8-8 | | 24251-8 | 24251RA8-8 | | 242R51-8 | | |
| | 19-22 | 0.042-0.028 | 1.07-0.71 | 1.016 | 1.116 | 25.8 | 28.4 | 24152-8 | 24152RA8-8 | 241R52-3 | 24252-8 | 24252RA8-8 | 242R52-3 | | 24M51-8* | |
| 1-1/4" (31.8mm) | 8 | 0.165 | 4.19 | 0.894 | 1.009 | 22.7 | 25.6 | 24149-8 | 24149RB8-8 | 241R47-3 | 24249-8 | 24249RB8-8 | 242R47-3 | 24M49-8* | | |
| | 9 | 0.148 | 3.76 | 0.924 | 1.039 | 23.5 | 26.4 | 24150-8 | 24150RB8-8 | 241R50-3 | 24250-8 | 24250RB8-8 | 242R50-3 | | | |
| | 10-11 | 0.134-0.120 | 3.40-3.05 | 0.962 | 1.083 | 24.4 | 27.5 | 24153-8 | 24153RA8-8 | 241R53-3 | 24253-8 | 24253RA8-8 | 242R53-3 | 24M53-8* | | |
| | 12-13 | 0.109-0.095 | 2.77-2.41 | 1.012 | 1.128 | 25.7 | 28.7 | 24155-8 | 24155RA8-8 | 241R52-3 | 24255-8 | 24255RA8-8 | 242R52-3 | | 24M55-8* | |
| | 14-17 | 0.083-0.058 | 2.11-1.47 | 1.066 | 1.195 | 27.1 | 30.3 | 24156-8 | 24156RA8-8 | 241R56-3 | 24256-8 | 24256RA8-8 | 242R56-3 | 24M56-8* | | |
| | 18-22 | 0.049-0.028 | 1.24-0.71 | 1.112 | 1.240 | 28.2 | 31.5 | 24157-8 | 24157RA8-8 | 241R57-3 | 24257-8 | 24257RA8-8 | 242R57-3 | | | |
| 1-3/8" (34.9mm) | 8 | 0.165 | 4.19 | 1.012 | 1.128 | 25.7 | 28.7 | 24155-8 | 24155RB8-8 | 241R52-3 | 24255-8 | 24255RB8-8 | 242R52-3 | 24M55-8* | | |
| | 9-10 | 0.148-0.134 | 3.76-3.40 | 1.066 | 1.195 | 27.1 | 30.3 | 24156-8 | 24156RB8-8 | 241R56-3 | 24256-8 | 24256RB8-8 | 242R56-3 | | 24M56-8* | |
| | 11 | 0.120 | 3.05 | 1.115 | 1.218 | 28.3 | 30.9 | 24158-8 | 24158RA8-8 | 241R58-3 | 24258-8 | 24258RA8-8 | 242R58-3 | 24M58-8* | | |
| | 12-13 | 0.109-0.095 | 2.77-2.41 | 1.127 | 1.263 | 28.6 | 32.1 | 24159-8 | 24159RA8-8 | 241R57-3 | 24259-8 | 24259RA8-8 | 242R57-3 | | 24M59-8* | |
| | 14-17 | 0.083-0.058 | 2.11-1.47 | 1.180 | 1.322 | 30.0 | 33.6 | 24160-8 | 24160RA8-8 | 241R60-3 | 24260-8 | 24260RA8-8 | 242R60-3 | 24M60-8* | | |
| | 18-22 | 0.049-0.028 | 1.24-0.71 | 1.224 | 1.365 | 31.1 | 34.7 | 24161-8 | 24161RA8-8 | 241R61-3 | 24261-8 | 24261RA8-8 | 242R61-3 | | | |
| 1-1/2" (38.1mm) | 8 | 0.165 | 4.19 | 1.127 | 1.263 | 28.6 | 32.1 | 24159-8 | 24159RB8-8 | 241R57-3 | 24259-8 | 24259RB8-8 | 242R57-3 | 24M59-8* | | |
| | 9-10 | 0.148-0.134 | 3.76-3.40 | 1.180 | 1.322 | 30.0 | 33.6 | 24160-8 | 24160RB8-8 | 241R60-3 | 24260-8 | 24260RB8-8 | 242R60-3 | | 24M60-8* | |
| | 11-12 | 0.120-0.109 | 3.05-2.77 | 1.224 | 1.365 | 31.1 | 34.7 | 24161-8 | 24161RB8-8 | 241R61-3 | 24261-8 | 24261RB8-8 | 242R61-3 | | | |
| | 13-14 | 0.095-0.083 | 2.41-2.11 | 1.285 | 1.415 | 32.6 | 35.9 | 24163-8 | 24163RA8-8 | | 24263-8 | 24263RA8-8 | | | | |
| | 15-17 | 0.072-0.058 | 1.83-1.47 | 1.325 | 1.455 | 33.7 | 36.9 | 24164-8 | 24164RA8-8 | 241R64-3 | 24264-8 | 24264RA8-8 | 242R64-3 | 24M63-8* | | |
| | 18-22 | 0.049-0.028 | 1.24-0.71 | 1.361 | 1.490 | 34.6 | 37.9 | 24165-8 | 24165RA8-8 | 241R65-3 | 24265-8 | 24265RA8-8 | 242R65-3 | | | |
| 1-3/4" (44.5mm) | 14-16 | 0.083-0.065 | 2.11-1.65 | 1.534 | 1.700 | 38.9 | 43.7 | 24166-8 | 24166RA8-8 | 241R66-3 | 24266-8 | 24266RA8-8 | 242R66-3 | 24M66-8** | | |
| 2" (50.8mm) | 13-16 | 0.095-0.065 | 2.41-1.65 | 1.750 | 1.952 | 44.0 | 49.6 | 24167-8 | 24167RA8-8 | 241R67-3 | 24267-8 | 24267RA8-8 | 242R67-3 | 24M67-8** | | |
| | 17-22 | 0.058-0.028 | 1.47-0.71 | 1.848 | 1.990 | 46.9 | 50.5 | 24169-8 | 24169RA8-8 | | 24269-8 | 24169RA8-8 | | 242R69-3 | 24M69-8** | |



24 SERIES

3 Roll Expanders - 12" Reach

Tube Size

- 0.500" to 2.000" OD
- (12.7 to 50.8mm) OD



3 Roll Expanders

| Tube Size | | Expansion Range | | Tube Sheet (Min/Max Reach) | | | | | | Tube Sheet (Min/Max Reach) | | | | Common Mandrel |
|------------------|-------------|-----------------|-----------|---------------------------------|-------|--------|----------|-------------------|--------------|---------------------------------|-------------------|--------------|----------------------|----------------|
| | | | | 1.500" - 11.830" (38.1-300.5mm) | | | | | | 2.250" - 12.200" (57.2-309.9mm) | | | | |
| OD | | Wall Thickness | | Inch | | Metric | | Expander Assembly | | Roll Set (3 per set) | Expander Assembly | | Roll Set (3 per set) | |
| | | BWG | In | Metric | Min. | Max. | Min. | Max. | Flush | | 1/8" Recess | Flush | | 1/8" Recess |
| 1/2" (12.7mm) | 14 | 0.083 | 2.11 | 0.324 | 0.366 | 8.4 | 9.3 | 24122-12 | 24122RB8-12 | 241R22-3** | 24222-12 | 24222RB8-12 | 242R22-3*** | 24M22-12 |
| | 15 | 0.072 | 1.83 | 0.346 | 0.386 | 8.8 | 9.7 | 24123-12 | 24123RA8-12 | | 24223-12 | 24223RA8-12 | | 24M23-12 |
| | 16-17 | 0.065-0.085 | 1.65-1.47 | 0.367 | 0.410 | 9.1 | 10.4 | 24124-12 | 24124RA8-12 | 241R24-3** | 24224-12 | 24224RA8-12 | 242R24-3*** | 24M24-12 |
| | 18 | 0.049 | 1.24 | 0.392 | 0.447 | 10.0 | 11.3 | 24125-12 | 24125RA8-12 | 241R25-3** | 24225-12 | 24225RA8-12 | 242R25-3*** | 24M25-12 |
| | 19-20 | 0.042-0.035 | 1.07-0.89 | 0.402 | 0.457 | 10.2 | 11.6 | 24126-12 | 24126RA8-12 | 241R26-3** | 24226-12 | 24226RA8-12 | 242R26-3*** | |
| 5/8" (15.9mm) | 21-22 | 0.035-0.028 | 0.81-0.71 | 0.425 | 0.482 | 10.8 | 12.3 | 24127-12 | 24127RA8-12 | 241R27-3** | 24227-12 | 24227RA8-12 | 242R27-3*** | 24M27-12 |
| | 12 | 0.109 | 2.77 | 0.392 | 0.447 | 10.0 | 11.3 | 24125-12 | 24125RB8-12 | 241R25-3** | 24225-12 | 24225RB8-12 | 242R25-3*** | 24M25-12 |
| | 13 | 0.095 | 2.41 | 0.425 | 0.482 | 10.8 | 12.3 | 24127-12 | 24127RB8-12 | 241R27-3** | 24227-12 | 24227RB8-12 | 242R27-3*** | 24M27-12 |
| | 14 | 0.083 | 2.11 | 0.449 | 0.506 | 11.4 | 12.8 | 24128-12 | 24128RA8-12 | 241R28-3 | 24228-12 | 24228RA8-12 | 242R28-3 | 24M28-12 |
| | 15 | 0.072 | 1.83 | 0.471 | 0.524 | 12.0 | 13.3 | 24129-12 | 24129RA8-12 | 241R29-3 | 24229-12 | 24229RA8-12 | 242R29-3 | 24M29-12 |
| | 16 | 0.065 | 1.65 | 0.485 | 0.538 | 12.3 | 13.7 | 24129B-12 | 24129BRA8-12 | | 24229B-12 | 24229BRA8-12 | | |
| | 17 | 0.058 | 1.47 | 0.499 | 0.564 | 12.7 | 14.3 | 24130-12 | 24130RA8-12 | 241R30-3 | 24230-12 | 24230RA8-12 | 242R30-3 | 24M30-12 |
| 18-19 | 0.049-0.042 | 1.24-1.07 | 0.517 | 0.584 | 13.1 | 14.8 | 24131-12 | 24131RA8-12 | 241R31-3 | 24231-12 | 24231RA8-12 | 242R31-3 | 24M31-12 | |
| 20-22 | 0.035-0.028 | 0.89-0.71 | 0.540 | 0.609 | 13.7 | 15.5 | 24132-12 | 24132RA8-12 | 241R32-3 | 24232-12 | 24232RA8-12 | 242R32-3 | 24M32-12 | |
| 3/4" (19.1mm) | 10 | 0.134 | 3.40 | 0.471 | 0.538 | 12.0 | 13.7 | 24129-12 | 24129RB8-12 | 241R29-3 | 24229-12 | 24229RB8-12 | 242R29-3 | 24M29-12 |
| | 11 | 0.120 | 3.05 | 0.499 | 0.564 | 12.7 | 14.3 | 24130-12 | 24130RB8-12 | 241R30-3 | 24230-12 | 24230RB8-12 | 242R30-3 | 24M30-12 |
| | 12 | 0.109 | 2.77 | 0.517 | 0.584 | 13.1 | 14.8 | 24131-12 | 24131RB8-12 | 241R31-3 | 24231-12 | 24231RB8-12 | 242R31-3 | 24M31-12 |
| | 13 | 0.095 | 2.41 | 0.540 | 0.609 | 13.7 | 15.5 | 24132-12 | 24132RB8-12 | 241R32-3 | 24232-12 | 24232RB8-12 | 242R32-3 | 24M32-12 |
| | 14 | 0.083 | 2.11 | 0.562 | 0.631 | 14.3 | 16.0 | 24133-12 | 24133RA8-12 | 241R33-3 | 24233-12 | 24233RA8-12 | 242R33-3 | |
| | 15-16 | 0.072-0.065 | 1.83-1.65 | 0.592 | 0.672 | 15.0 | 17.1 | 24134-12 | 24134RA8-12 | 241R34-3 | 24234-12 | 24234RA8-12 | 242R34-3 | 24M34-12 |
| | 17-18 | 0.058-0.049 | 1.47-1.24 | 0.620 | 0.697 | 15.7 | 17.7 | 24135-12 | 24135RA8-12 | 241R35-3 | 24235-12 | 24235RA8-12 | 242R35-3 | 24M35-12 |
| 19-22 | 0.042-0.028 | 1.07-0.71 | 0.641 | 0.731 | 16.3 | 18.6 | 24136-12 | 24136RA8-12 | 241R36-3 | 24236-12 | 24236RA8-12 | 242R36-3 | 24M36-12 | |
| 7/8" (22.2mm) | 10 | 0.134 | 3.40 | 0.592 | 0.672 | 15.0 | 17.1 | 24134-12 | 24134RB8-12 | 241R34-3 | 24234-12 | 24234RB8-12 | 242R34-3 | 24M34-12 |
| | 11 | 0.120 | 3.05 | 0.620 | 0.697 | 15.7 | 17.7 | 24135-12 | 24135RB8-12 | 241R35-3 | 24235-12 | 24235RB8-12 | 242R35-3 | 24M35-12 |
| | 12 | 0.109 | 2.77 | 0.641 | 0.731 | 16.3 | 18.6 | 24136-12 | 24136RB8-12 | 241R36-3 | 24236-12 | 24236RB8-12 | 242R36-3 | 24M36-12 |
| | 13 | 0.095 | 2.41 | 0.655 | 0.745 | 16.6 | 18.9 | 24138-12 | 24138RA8-12 | 241R38-3 | 24238-12 | 24238RA8-12 | 242R38-3 | |
| | 14 | 0.083 | 2.11 | 0.675 | 0.765 | 17.1 | 19.4 | 24139-12 | 24139RA8-12 | 241R39-3 | 24239-12 | 24239RA8-12 | 242R39-3 | |
| | 15-16 | 0.072-0.065 | 1.83-1.65 | 0.715 | 0.800 | 18.2 | 20.3 | 24140-12 | 24140RA8-12 | | 24240-12 | 24240RA8-12 | 242R40-12 | 24M40-12 |
| | 17-19 | 0.058-0.049 | 1.47-1.07 | 0.743 | 0.828 | 18.9 | 21.0 | 24141-12 | 24141RA8-12 | 241R41-3 | 24241-12 | 24241RA8-12 | 242R41-3 | 24M41-12 |
| 20-22 | 0.035-0.028 | 0.89-0.71 | 0.795 | 0.865 | 20.2 | 22.0 | 24142-12 | 24142RA8-12 | 241R42-3 | 24242-12 | 24242RA8-12 | 242R42-3 | 24M42-12 | |
| 1" (25.4mm) | 8 | 0.165 | 4.19 | 0.655 | 0.745 | 16.6 | 18.9 | 24138-12 | 24138RB8-12 | 241R38-3 | 24238-12 | 24238RB8-12 | 242R38-3 | 24M36-12 |
| | 9 | 0.148 | 3.76 | 0.675 | 0.765 | 17.1 | 19.4 | 24139-12 | 24139RB8-12 | 241R39-3 | 24239-12 | 24239RB8-12 | 242R39-3 | 24M40-12 |
| | 10 | 0.134 | 3.40 | 0.715 | 0.800 | 18.2 | 20.3 | 24140-12 | 24140RB8-12 | | 24240-12 | 24240RB8-12 | | |
| | 11 | 0.120 | 3.05 | 0.743 | 0.828 | 18.9 | 21.0 | 24141-12 | 24141RB8-12 | 241R41-3 | 24241-12 | 24241RB8-12 | 242R41-3 | 24M43-12 |
| | 12-13 | 0.109-0.095 | 2.77-2.41 | 0.769 | 0.866 | 19.5 | 22.0 | 24143-12 | 24143RA8-12 | 241R42-3 | 24243-12 | 24243RA8-12 | 242R42-3 | |
| | 14 | 0.083 | 2.11 | 0.799 | 0.896 | 20.3 | 22.7 | 24144-12 | 24144RA8-12 | 241R44-3 | 24244-12 | 24244RA8-12 | 242R44-3 | 24M45-12* |
| | 15-16 | 0.072-0.065 | 1.83-1.65 | 0.841 | 0.922 | 21.4 | 23.4 | 24145-12 | 24145RA8-12 | | 24245-12 | 24245RA8-12 | | |
| | 17-19 | 0.058-0.042 | 1.47-1.07 | 0.872 | 0.968 | 22.1 | 24.6 | 24146-12 | 24146RA8-12 | 241R46-3 | 24246-12 | 24246RA8-12 | 242R46-3 | 24M46-12* |
| 20-22 | 0.035-0.028 | 0.89-0.71 | 0.894 | 0.990 | 22.7 | 25.2 | 24147-12 | 24147RA8-12 | 241R47-3 | 24247-12 | 24247RA8-12 | 242R47-3 | | |



Mandrel drive square size is 3/8". *Mandrel drive square size is 1/2". **Mandrel drive square size is 3/4".
Extended reaches available upon request.

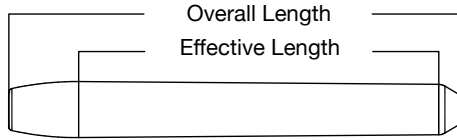

| Roll Part Number | Overall Roll Length | Effective Roll Length |
|------------------|---------------------|-----------------------|
| 241R21 - 241R27 | 1.500" (38.1mm) | 1.187" (30.1mm) |
| 241R28 - 241R42 | 1.625" (41.3mm) | 1.301" (33.0mm) |
| 241R43 - 241R69 | | 1.239" (31.5mm) |
| 242R21 - 242R27 | 2.250" (57.2mm) | 1.937" (49.2mm) |
| 242R28 - 242R42 | 2.365" (60.3mm) | 2.051" (52.1mm) |
| 242R43 - 242R69 | | 1.989" (50.5mm) |

| 3 Roll Expanders | | | | | | | | | | | | | | | |
|--------------------|----------------|-------------|-----------------|-------|-------|--------|---------------------------------|-------------------|-------------|----------------------|---------------------------------|-------------|----------------------|------------|----------------|
| Tube Size | | | Expansion Range | | | | Tube Sheet (Min/Max Reach) | | | | Tube Sheet (Min/Max Reach) | | | | Common Mandrel |
| | | | | | | | 1.500" - 11.830" (38.1-300.5mm) | | | | 2.250" - 12.200" (57.2-309.9mm) | | | | |
| OD | Wall Thickness | | | Inch | | Metric | | Expander Assembly | | Roll Set (3 per set) | Expander Assembly | | Roll Set (3 per set) | | |
| | BWG | In | Metric | Min. | Max. | Min. | Max. | Flush | 1/8" Recess | | Flush | 1/8" Recess | | | |
| 1-1/8" (28.6mm) | 8 | 0.165 | 4.19 | 0.769 | 0.866 | 19.5 | 22.0 | 24143-12 | 24143RB8-12 | 241R42-3 | 24243-12 | 24243RB8-12 | 242R42-3 | 24M43-12 | |
| | 9 | 0.148 | 3.76 | 0.799 | 0.896 | 20.3 | 22.7 | 24144-12 | 24144RB8-12 | 241R44-3 | 24244-12 | 24244RB8-12 | 242R44-3 | 24M45-12* | |
| | 10 | 0.134 | 3.40 | 0.841 | 0.922 | 21.4 | 23.4 | 24145-12 | 24145RB8-12 | | 24245-12 | 24245RB8-12 | | 24M46-12* | |
| | 11-12 | 0.120-0.109 | 3.05-2.77 | 0.872 | 0.968 | 22.1 | 24.6 | 24146-12 | 24146RB8-12 | 241R46-3 | 24246-12 | 24246RB8-12 | 242R46-3 | 24M46-12* | |
| | 13 | 0.095 | 2.41 | 0.894 | 1.009 | 22.7 | 25.6 | 24149-12 | 24149RA8-12 | 241R47-3 | 24249-12 | 24249RA8-12 | 242R47-3 | 24M49-12* | |
| | 14-15 | 0.083-0.072 | 2.11-1.83 | 0.924 | 1.039 | 23.5 | 26.4 | 24150-12 | 24150RA8-12 | 241R50-3 | 24250-12 | 24250RA8-12 | 242R50-3 | 24M51-12* | |
| | 16-18 | 0.065-0.049 | 1.65-1.24 | 0.978 | 1.078 | 24.8 | 27.4 | 24151-12 | 24151RA8-12 | | 24251-12 | 24251RA8-12 | | 24M51-12* | |
| 19-22 | 0.042-0.028 | 1.07-0.71 | 1.016 | 1.116 | 25.8 | 28.4 | 24152-12 | 24152RA8-12 | 241R52-3 | 24252-12 | 24252RA8-12 | 242R52-3 | | | |
| 1-1/4" (31.8mm) | 8 | 0.165 | 4.19 | 0.894 | 1.009 | 22.7 | 25.6 | 24149-12 | 24149RB8-12 | 241R47-3 | 24249-12 | 24249RB8-12 | 242R47-3 | 24M49-12* | |
| | 9 | 0.148 | 3.76 | 0.924 | 1.039 | 23.5 | 26.4 | 24150-12 | 24150RB8-12 | 241R50-3 | 24250-12 | 24250RB8-12 | 242R50-3 | | |
| | 10-11 | 0.134-0.120 | 3.40-3.05 | 0.962 | 1.083 | 24.4 | 27.5 | 24153-12 | 24153RA8-12 | 241R53-3 | 24253-12 | 24253RA8-12 | 242R53-3 | 24M53-12* | |
| | 12-13 | 0.109-0.095 | 2.77-2.41 | 1.012 | 1.128 | 25.7 | 28.7 | 24155-12 | 24155RA8-12 | 241R52-3 | 24255-12 | 24255RA8-12 | 242R52-3 | 24M55-12* | |
| | 14-17 | 0.083-0.058 | 2.11-1.47 | 1.066 | 1.195 | 27.1 | 30.3 | 24156-12 | 24156RA8-12 | 241R56-3 | 24256-12 | 24256RA8-12 | 242R56-3 | 24M56-12* | |
| 1-3/8" (34.9mm) | 18-22 | 0.049-0.028 | 1.24-0.71 | 1.112 | 1.240 | 28.2 | 31.5 | 24157-12 | 24157RA8-12 | 241R57-3 | 24257-12 | 24257RA8-12 | 242R57-3 | | |
| | 8 | 0.165 | 4.19 | 1.012 | 1.128 | 25.7 | 28.7 | 24155-12 | 24155RB8-12 | 241R52-3 | 24255-12 | 24255RB8-12 | 242R52-3 | 24M55-12* | |
| | 9-10 | 0.148-0.134 | 3.76-3.40 | 1.066 | 1.195 | 27.1 | 30.3 | 24156-12 | 24156RB8-12 | 241R56-3 | 24256-12 | 24256RB8-12 | 242R56-3 | 24M56-12* | |
| | 11 | 0.120 | 3.05 | 1.115 | 1.218 | 28.3 | 30.9 | 24158-12 | 24158RA8-12 | 241R58-3 | 24258-12 | 24258RA8-12 | 242R58-3 | 24M58-12* | |
| | 12-13 | 0.109-0.095 | 2.77-2.41 | 1.127 | 1.263 | 28.6 | 32.1 | 24159-12 | 24159RA8-12 | 241R57-3 | 24259-12 | 24259RA8-12 | 242R57-3 | 24M59-12* | |
| | 14-17 | 0.083-0.058 | 2.11-1.47 | 1.180 | 1.322 | 30.0 | 33.6 | 24160-12 | 24160RA8-12 | 241R60-3 | 24260-12 | 24260RA8-12 | 242R60-3 | 24M60-12* | |
| 1-1/2" (38.1mm) | 18-22 | 0.049-0.028 | 1.24-0.71 | 1.224 | 1.365 | 31.1 | 34.7 | 24161-12 | 24161RA8-12 | 241R61-3 | 24261-12 | 24261RA8-12 | 242R61-3 | | |
| | 8 | 0.165 | 4.19 | 1.127 | 1.263 | 28.6 | 32.1 | 24159-12 | 24159RB8-12 | 241R57-3 | 24259-12 | 24259RB8-12 | 242R57-3 | 24M59-12* | |
| | 9-10 | 0.148-0.134 | 3.76-3.40 | 1.180 | 1.322 | 30.0 | 33.6 | 24160-12 | 24160RB8-12 | 241R60-3 | 24260-12 | 24260RB8-12 | 242R60-3 | 24M60-12* | |
| | 11-12 | 0.120-0.109 | 3.05-2.77 | 1.224 | 1.365 | 31.1 | 34.7 | 24161-12 | 24161RB8-12 | 241R61-3 | 24261-12 | 24261RB8-12 | 242R61-3 | | |
| | 13-14 | 0.095-0.083 | 2.41-2.11 | 1.285 | 1.415 | 32.6 | 35.9 | 24163-12 | 24163RA8-12 | | 24263-12 | 24263RA8-12 | | 24M63-12* | |
| | 15-17 | 0.072-0.058 | 1.83-1.47 | 1.325 | 1.455 | 33.7 | 36.9 | 24164-12 | 24164RA8-12 | 241R64-3 | 24264-12 | 24264RA8-12 | 242R64-3 | | |
| 18-22 | 0.049-0.028 | 1.24-0.71 | 1.361 | 1.490 | 34.6 | 37.9 | 24165-12 | 24165RA8-12 | 241R65-3 | 24265-12 | 24265RA8-12 | 242R65-3 | | | |
| 1-3/4" (44.5mm) | 14-16 | 0.083-0.065 | 2.11-1.65 | 1.534 | 1.700 | 38.9 | 43.7 | 24166-12 | 24166RA8-12 | 241R66-3 | 24266-12 | 24266RA8-12 | 242R66-3 | 24M66-12** | |
| 2" (50.8mm) | 13-16 | 0.095-0.065 | 2.41-1.65 | 1.750 | 1.952 | 44.0 | 49.6 | 24167-12 | 24267RA8-12 | 241R67-3 | 24267-12 | 24267RA8-12 | 242R67-3 | 24M67-12** | |
| | 17-22 | 0.058-0.028 | 1.47-0.71 | 1.848 | 1.990 | 46.9 | 50.5 | 24169-12 | 24169RA8-12 | | 24269-12 | 24169RA8-12 | 242R67-3 | 24M69-12** | |



24 SERIES

4 & 5 Roll Expanders

Tube Size

- 0.625" to 1.500" OD
- (15.9 to 38.1mm) OD



24 SERIES

| 4 Roll Expanders | | | | | | | | | | | | | |
|------------------|----------------|-------------|-----------------|-------|-------|--------|---|-------------------------|----------------------|--|----------------------|---------|----------------|
| Tube Size | | | Expansion Range | | | | Tube Sheet (Min/Max Reach) 0.500" - 3.830" (12.7-97.3mm) Overall Roll Length 1-5/8" (41.3mm) | | | Tube Sheet (Min/Max Reach) 1.250" - 4.200" (31.8-106.7mm) Overall Roll Length 2-3/8" (60.3mm) | | | Common Mandrel |
| OD | Wall Thickness | | | Inch | | Metric | | Expander Assembly Flush | Roll Set (4 per set) | Expander Assembly Flush | Roll Set (4 per set) | | |
| | BWG | In | Metric | Min. | Max. | Min. | Max. | | | | | | |
| 5/8" (15.9mm) | 18-19 | 0.049-0.042 | 1.24-1.07 | 0.512 | 0.583 | 13.0 | 14.8 | 24131-4 | 241R29-4 | 24231-4 | 242R29-4 | 24M31-4 | |
| | 20-24 | 0.035-0.022 | 0.89-0.56 | 0.538 | 0.609 | 13.7 | 15.5 | 24132-4 | 241R31-4 | 24232-4 | 242R31-4 | 24M31-4 | |

| 5 Roll Expanders | | | | | | | | | | | | | | |
|--------------------|----------------|-------------|-----------|-----------------|-------|--------|------|---|-------------|----------------------|--|-------------|----------------------|----------------|
| Tube Size | | | | Expansion Range | | | | Tube Sheet (Min/Max Reach) 0.500" - 3.830" (12.7-97.3mm) Overall Roll Length 1-5/8" (41.3mm) | | | Tube Sheet (Min/Max Reach) 1.250" - 4.200" (31.8-106.7mm) Overall Roll Length 2-3/8" (60.3mm) | | | Common Mandrel |
| OD | Wall Thickness | | | Inch | | Metric | | Expander Assembly | | Roll Set (5 per set) | Expander Assembly | | Roll Set (5 per set) | |
| | BWG | In | Metric | Min. | Max. | Min. | Max. | Flush | 1/8" Recess | | Flush | 1/8" Recess | | |
| 3/4" (19.1mm) | 12 | 0.109 | 2.77 | 0.517 | 0.584 | 13.1 | 14.8 | 24131-5 | 24131RB8-5 | 241R28-5 | 24231-5 | 24231RB8-5 | 242R28-5 | 24M31-5 |
| | 13 | 0.095 | 2.41 | 0.540 | 0.609 | 13.7 | 15.5 | 24132-5 | 24132RB8-5 | 241R29-5 | 24232-5 | 24232RB8-5 | 242R29-5 | 24M32-5 |
| | 14 | 0.083 | 2.11 | 0.562 | 0.631 | 14.3 | 16.0 | 24133-5 | 24133RA8-5 | 241R30-5 | 24233-5 | 24233RA8-5 | 242R30-5 | 24M33-5 |
| | 15-17 | 0.072-0.058 | 1.83-1.47 | 0.592 | 0.672 | 15.0 | 17.1 | 24134-5 | 24134RA8-5 | 241R31-5 | 24234-5 | 24234RA8-5 | 242R31-5 | 24M34-5 |
| | 18-19 | 0.049-0.042 | 1.24-1.07 | 0.626 | 0.711 | 15.9 | 18.1 | 24136-5 | 24136RA8-5 | 241R33-5 | 24236-5 | 24236RA8-5 | 242R33-5 | 24M36-5 |
| | 20-24 | 0.035-0.022 | 0.89-0.56 | 0.655 | 0.740 | 16.6 | 18.8 | 24137-5 | 24137RA8-5 | 241R34-5 | 24237-5 | 24237RA8-5 | 242R34-5 | 24M37-5 |
| 7/8" (22.2mm) | 18-19 | 0.049-0.042 | 1.24-1.07 | 0.749 | 0.831 | 19.0 | 21.1 | 24141-5 | 24141RB8-5 | 241R36-5 | 24241-5 | 24241RB8-5 | 242R36-5 | 24M41-5* |
| | 20-24 | 0.035-0.022 | 0.89-0.56 | 0.783 | 0.865 | 19.9 | 22.0 | 24142-5 | - | 241R39-5 | 24242-5 | - | 242R39-5 | 24M41-5* |
| 1" (25.4mm) | 11 | 0.120 | 3.05 | 0.749 | 0.831 | 19.0 | 21.1 | 24141-5 | 24141RB8-5 | 241R36-5 | 24241-5 | 24241RB8-5 | 242R36-5 | 24M41-5* |
| | 12-13 | 0.109-0.095 | 2.77-2.41 | 0.769 | 0.866 | 19.5 | 22.0 | 24143-5 | 24143RA8-5 | 241R39-5 | 24243-5 | 24243RA8-5 | 242R39-5 | 24M43-5* |
| | 14 | 0.083 | 2.11 | 0.799 | 0.896 | 20.3 | 22.7 | 24144-5 | 24144RA8-5 | 241R41-5 | 24244-5 | 24244RA8-5 | 242R41-5 | 24M44-5* |
| | 15-17 | 0.072-0.058 | 1.83-1.47 | 0.841 | 0.922 | 21.4 | 23.4 | 24145-5 | 24145RA8-5 | 241R41-5 | 24245-5 | 24245RA8-5 | 242R41-5 | 24M45-5* |
| | 18-19 | 0.049-0.042 | 1.24-1.07 | 0.880 | 0.976 | 22.4 | 24.8 | 24146-5 | 24146RA8-5 | 241R42-5 | 24246-5 | 24246RA8-5 | 242R42-5 | 24M46-5* |
| | 20-24 | 0.035-0.022 | 0.89-0.56 | 0.894 | 0.990 | 22.7 | 25.2 | 24147-5 | 24147RA8-5 | 241R43-5 | 24247-5 | 24247RA8-5 | 242R43-5 | 24M46-5* |
| 1-1/8" (28.6mm) | 18-24 | 0.049-0.022 | 1.24-0.56 | 0.997 | 1.116 | 25.3 | 28.4 | 24152-5 | - | 241R47-5 | 24252-5 | - | 242R47-5 | 24M52-5* |
| 1-1/4" (31.8mm) | 18-24 | 0.049-0.022 | 1.24-0.56 | 1.112 | 1.240 | 28.2 | 31.5 | 24157-5 | - | 241R52-5 | 24257-5 | - | 242R52-5 | 24M57-5* |
| 1-3/8" (34.9mm) | 18-24 | 0.049-0.022 | 1.24-0.56 | 1.237 | 1.365 | 31.4 | 34.7 | 24161-5 | - | 241R58-5 | 24261-5 | - | 242R58-5 | 24M61-5* |
| 1-1/2" (38.1mm) | 18-24 | 0.049-0.022 | 1.24-0.56 | 1.361 | 1.490 | 34.6 | 37.9 | 24165-5 | 24165RA8-5 | 241R60-5 | 24265-5 | 24265RA8-5 | 242R60-5 | 24M65-5* |
| 2" (50.8mm) | 17-22 | 0.058-0.028 | 1.47-0.71 | 1.840 | 1.990 | 46.7 | 50.5 | 24169-5 | 24169RA8-5 | 241R66-5 | 24269-5 | 24269RA8-5 | 242R66-5 | 24M69-5* |

Mandrel drive square size is 3/8". *Mandrel drive square size is 1/2".

| Roll Part Number | Overall Roll Length | Effective Roll Length |
|------------------|---------------------|-----------------------|
| 241R28 - 241R42 | 1.625" (41.3mm) | 1.301" (33.0mm) |
| 241R43 - 241R69 | | 1.239" (31.5mm) |
| 242R28 - 242R42 | 2.365" (60.3mm) | 2.051" (52.1mm) |
| 242R43 - 242R69 | | 1.989" (50.5mm) |

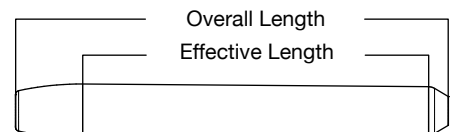

BOOST PRODUCTIVITY WITHOUT BREAKING THE BUDGET

Rent Elliott's premium tube tools and experience proven performance—without the upfront investment.

Why rent from Elliott?

Perhaps you could benefit from the productivity that a tool would bring but do not anticipate enough usage to cost-effectively justify the purchase. Or maybe you would just like to “try before you buy”. Look no further because Elliott offers more than **430 tube tool SKUs** for rent.

Rent from us today

When you're ready to purchase, receive **50%** credit of your current rental charges toward a new or used tool of the same model.



Learn more about rentals at
elliott-tool.com or contact us today



445 SERIES RIGHT ANGLE
ROLLING MOTORS



COLLET STYLE TUBE TUGGER



STUB TUGGER

24 SERIES

4 & 5 Roll Expanders With Nylon Pilot

Tube Size

- 0.625" to 1.500" OD
- (15.9 to 38.1mm) OD



4 Roll Expanders

| Tube Size | | Expansion Range | | Tube Sheet (Min/Max Reach) 0.500" - 3.830" (12.7-97.3mm) Overall Roll Length 1-5/8" (41.3mm) | | | | Tube Sheet (Min/Max Reach) 1.250" - 4.200" (31.8-106.7mm) Overall Roll Length 2-3/8" (60.3mm) | | | | Common Mandrel | Mandrel Drive Square |
|------------------|----------------|-----------------|-----------|---|-------|--------|------|--|----------------------|--|----------------------|----------------|----------------------|
| OD | Wall Thickness | | | Inch | | Metric | | Expander Assembly Nylon Pilot With Thin Wall Collar* | Roll Set (4 per set) | Expander Assembly Nylon Pilot With Thin Wall Collar* | Roll Set (4 per set) | | |
| | BWG | In | Metric | Min. | Max. | Min. | Max. | | | | | | |
| 5/8" (15.9mm) | 18-19 | 0.049-0.042 | 1.24-1.07 | 0.512 | 0.583 | 13.0 | 14.8 | 24131PTW-4 | 241R29-4 | 24231PTW-4 | 242R29-4 | 24MP31-4 | 3/8" |
| | 20-24 | 0.035-0.022 | 0.89-0.56 | 0.538 | 0.609 | 13.7 | 15.5 | 24132PTW-4 | 241R31-4 | 24232PTW-4 | 242R31-4 | 24MP31-4 | |

*Nylon Pilot Expander Assembly comes with Thin Wall Collar. For other collar options, contact Elliott.

5 Roll Expanders

| Tube Size | | Expansion Range | | Tube Sheet (Min/Max Reach) 0.500" - 3.830" (12.7-97.3mm) Overall Roll Length 1-5/8" (41.3mm) | | | | Tube Sheet (Min/Max Reach) 1.250" - 4.200" (31.8-106.7mm) Overall Roll Length 2-3/8" (60.3mm) | | | | Common Mandrel | Mandrel Drive Square |
|--------------------|----------------|-----------------|-----------|---|-------|--------|------|--|----------------------|--|----------------------|----------------|----------------------|
| OD | Wall Thickness | | | Inch | | Metric | | Expander Assembly Nylon Pilot With Thin Wall Collar* | Roll Set (5 per set) | Expander Assembly Nylon Pilot With Thin Wall Collar* | Roll Set (5 per set) | | |
| | BWG | In | Metric | Min. | Max. | Min. | Max. | | | | | | |
| 3/4" (19.1mm) | 18-19 | 0.049-0.042 | 1.24-1.07 | 0.626 | 0.711 | 15.9 | 18.1 | 24136PTW-5 | 241R33-5 | 24236PTW-5 | 242R33-5 | 24MP36-5 | 3/8" |
| | 20-24 | 0.035-0.022 | 0.89-0.56 | 0.655 | 0.740 | 16.6 | 18.8 | 24137PTW-5 | 241R34-5 | 24237PTW-5 | 242R34-5 | 24MP37-5 | |
| 7/8" (22.2mm) | 18-19 | 0.049-0.042 | 1.24-1.07 | 0.749 | 0.831 | 19.0 | 21.1 | 24141PTW-5 | 241R36-5 | 24241PTW-5 | 242R36-5 | 24MP41-5 | 1/2" |
| | 20-24 | 0.035-0.022 | 0.89-0.56 | 0.783 | 0.865 | 19.9 | 22.0 | 24142PTW-5 | 241R39-5 | 24242PTW-5 | 242R39-5 | 24MP41-5 | |
| 1" (25.4mm) | 18-19 | 0.049-0.042 | 1.24-1.07 | 0.880 | 0.976 | 22.4 | 24.8 | 24146PTW-5 | 241R42-5 | 24246PTW-5 | 242R42-5 | 24MP46-5 | 1/2" |
| | 20-24 | 0.035-0.022 | 0.89-0.56 | 0.894 | 0.990 | 22.7 | 25.2 | 24147PTW-5 | 241R43-5 | 24247PTW-5 | 242R43-5 | 24MP46-5 | |
| 1-1/8" (28.6mm) | 18-24 | 0.049-0.022 | 1.24-0.56 | 0.997 | 1.116 | 25.3 | 28.4 | 24152PTW-5 | 241R47-5 | 24252PTW-5 | 242R47-5 | 24MP52-5 | 1/2" |
| 1-1/4" (31.8mm) | 18-24 | 0.049-0.022 | 1.24-0.56 | 1.112 | 1.240 | 28.2 | 31.5 | 24157PTW-5 | 241R52-5 | 24257PTW-5 | 242R52-5 | 24MP57-5 | |
| 1-3/8" (34.9mm) | 18-24 | 0.049-0.022 | 1.24-0.56 | 1.237 | 1.365 | 31.4 | 34.7 | 24161PTW-5 | 241R58-5 | 24261PTW-5 | 242R58-5 | 24MP61-5 | 1/2" |
| 1-1/2" (38.1mm) | 18-24 | 0.049-0.022 | 1.24-0.56 | 1.361 | 1.490 | 34.6 | 37.9 | 24165PTW-5 | 241R60-5 | 24265PTW-5 | 242R60-5 | 24MP65-5 | |

*Nylon Pilot Expander Assembly comes with Thin Wall Collar. For other collar options, contact Elliott.

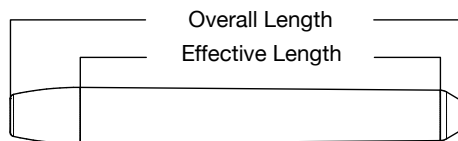

| Roll Part Number | Overall Roll Length | Effective Roll Length |
|------------------|---------------------|-----------------------|
| 241R28 - 241R42 | 1.625" (41.3mm) | 1.301" (33.0mm) |
| 241R43 - 241R69 | | 1.239" (31.5mm) |
| 242R28 - 242R42 | 2.365" (60.3mm) | 2.051" (52.1mm) |
| 242R43 - 242R69 | | 1.989" (50.5mm) |



Tube Size

- 0.750" to 1.000" OD
- (19.0 to 25.4mm) OD

| Roll Part Number | Overall Roll Length | Effective Roll Length |
|------------------|---------------------|-----------------------|
| 241R28 - 241R42 | 1.625" (41.3mm) | 1.301" (33.0mm) |
| 241R43 - 241R69 | | 1.239" (31.5mm) |
| 242R28 - 242R42 | 2.365" (60.3mm) | 2.051" (52.1mm) |
| 242R43 - 242R69 | | 1.989" (50.5mm) |

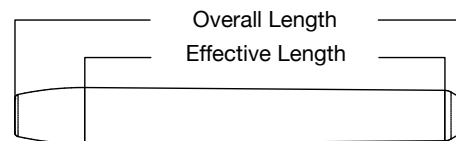

24 SERIES

| 5 Roll Expanders - 8" Reach | | | | | | | | | | | | | | | |
|-----------------------------|----------------|-------------|-----------------|-------|-------|--------|---|-------------------|--------------|----------|---|-------------------|----------|----------------|-------------------------|
| Tube Size | | | Expansion Range | | | | Tube Sheet (Min/Max Reach) 0.500"-7.830" (12.7-198.9mm) Overall Roll Length 1-5/8" (41.3mm) | | | | Tube Sheet (Min/Max Reach) 1.250" - 8.200" (31.8-208.3mm) Overall Roll Length 2-3/8" (60.3mm) | | | Common Mandrel | |
| OD | Wall Thickness | | | Inch | | Metric | | Expander Assembly | | | Roll Set (5 per set) | Expander Assembly | | | Roll Set (5 per set) |
| | BWG | In | Metric | Min. | Max. | Min. | Max. | Flush | 1/8" Recess | Flush | | 1/8" Recess | | | |
| 3/4" (19.1mm) | 12 | 0.109 | 2.77 | 0.517 | 0.584 | 13.1 | 14.8 | 24131-5-8 | 24131RB8-5-8 | 241R28-5 | 24231-5-8 | 24231RB8-5-8 | 242R28-5 | 24M31-5-8 | |
| | 13 | 0.095 | 2.41 | 0.540 | 0.609 | 13.7 | 15.5 | 24132-5-8 | 24132RB8-5-8 | 241R29-5 | 24232-5-8 | 24232RB8-5-8 | 242R29-5 | 24M32-5-8 | |
| | 14 | 0.083 | 2.11 | 0.562 | 0.631 | 14.3 | 16.0 | 24133-5-8 | 24133RA8-5-8 | 241R30-5 | 24233-5-8 | 24233RA8-5-8 | 242R30-5 | 24M33-5-8 | |
| | 15-16 | 0.072-0.065 | 1.83-1.65 | 0.592 | 0.672 | 15.0 | 17.1 | 24134-5-8 | 24134RA8-5-8 | 241R31-5 | 24234-5-8 | 24234RA8-5-8 | 242R31-5 | 24M34-5-8 | |
| | 17-19 | 0.058-0.042 | 1.47-1.07 | 0.626 | 0.711 | 15.9 | 18.0 | 24136-5-8 | 24136RA8-5-8 | 241R33-5 | 24236-5-8 | 24236RA8-5-8 | 242R33-5 | 24M36-5-8 | |
| | 20-24 | 0.035-0.022 | 0.89-0.56 | 0.655 | 0.740 | 16.6 | 18.8 | 24137-5-8 | 24137RA8-5-8 | 241R34-5 | 24237-5-8 | 24237RA8-5-8 | 242R34-5 | 24M37-5-8 | |
| 1" (25.4mm) | 11 | 0.120 | 3.05 | 0.749 | 0.831 | 19.0 | 21.1 | 24141-5-8 | 24141RB8-5-8 | 241R36-5 | 24241-5-8 | 24241RB8-5-8 | 242R36-5 | 24M41-5-8* | |
| | 12-13 | 0.109-0.095 | 2.77-2.41 | 0.769 | 0.866 | 19.5 | 22.0 | 24143-5-8 | 24143RA8-5-8 | 241R39-5 | 24243-5-8 | 24243RA8-5-8 | 242R39-5 | 24M43-5-8* | |
| | 14 | 0.083 | 2.11 | 0.799 | 0.896 | 20.3 | 22.7 | 24144-5-8 | 24144RA8-5-8 | 241R41-5 | 24244-5-8 | 24244RA8-5-8 | 242R41-5 | 24M44-5-8* | |
| | 15-16 | 0.072-0.065 | 1.83-1.65 | 0.841 | 0.922 | 21.4 | 23.4 | 24145-5-8 | 24145RA8-5-8 | 241R41-5 | 24245-5-8 | 24245RA8-5-8 | 242R41-5 | 24M45-5-8* | |
| | 17-19 | 0.058-0.042 | 1.47-1.07 | 0.880 | 0.976 | 22.3 | 24.8 | 24146-5-8 | 24146RA8-5-8 | 241R42-5 | 24246-5-8 | 24246RA8-5-8 | 242R42-5 | 24M46-5-8* | |
| | 20-24 | 0.035-0.022 | 0.89-0.56 | 0.894 | 0.990 | 22.7 | 25.2 | 24147-5-8 | 24147RA8-5-8 | 241R43-5 | 24247-5-8 | 24247RA8-5-8 | 242R43-5 | 24M46-5-8* | |

Mandrel drive square size is 3/8". *Mandrel drive square size is 1/2". **Mandrel drive square size is 3/4".

| 5 Roll Expanders - 12" Reach | | | | | | | | | | | | | | | |
|------------------------------|----------------|-------------|-----------------|-------|-------|--------|--|-------------------|---------------|----------|--|-------------------|----------|----------------|-------------------------|
| Tube Size | | | Expansion Range | | | | Tube Sheet (Min/Max Reach) 1.500"-11.830" (38.1-300.5mm) Overall Roll Length 1-5/8" (41.3mm) | | | | Tube Sheet (Min/Max Reach) 2.250" - 12.200" (57.2-309.9mm) Overall Roll Length 2-3/8" (60.3mm) | | | Common Mandrel | |
| OD | Wall Thickness | | | Inch | | Metric | | Expander Assembly | | | Roll Set (5 per set) | Expander Assembly | | | Roll Set (5 per set) |
| | BWG | In | Metric | Min. | Max. | Min. | Max. | Flush | 1/8" Recess | Flush | | 1/8" Recess | | | |
| 3/4" (19.1mm) | 12 | 0.109 | 2.77 | 0.517 | 0.584 | 13.1 | 14.8 | 24131-5-12 | 24131RB8-5-12 | 241R28-5 | 24231-5-12 | 24231RB8-5-12 | 242R28-5 | 24M31-5-12 | |
| | 13 | 0.095 | 2.41 | 0.540 | 0.609 | 13.7 | 15.5 | 24132-5-12 | 24132RB8-5-12 | 241R29-5 | 24232-5-12 | 24232RB8-5-12 | 242R29-5 | 24M32-5-12 | |
| | 14 | 0.083 | 2.11 | 0.562 | 0.631 | 14.3 | 16.0 | 24133-5-12 | 24133RA8-5-12 | 241R30-5 | 24233-5-12 | 24233RA8-5-12 | 242R30-5 | 24M33-5-12 | |
| | 15-16 | 0.072-0.065 | 1.83-1.65 | 0.592 | 0.672 | 15.0 | 17.1 | 24134-5-12 | 24134RA8-5-12 | 241R31-5 | 24234-5-12 | 24234RA8-5-12 | 242R31-5 | 24M34-5-12 | |
| | 17-19 | 0.058-0.042 | 1.47-1.07 | 0.626 | 0.711 | 15.9 | 18.1 | 24136-5-12 | 24136RA8-5-12 | 241R33-5 | 24236-5-12 | 24236RA8-5-12 | 242R33-5 | 24M36-5-12 | |
| | 20-24 | 0.035-0.022 | 0.89-0.56 | 0.655 | 0.740 | 16.6 | 18.8 | 24137-5-12 | 24137RA8-5-12 | 241R34-5 | 24237-5-12 | 24237RA8-5-12 | 242R34-5 | 24M37-5-12 | |
| 1" (25.4mm) | 11 | 0.120 | 3.05 | 0.749 | 0.831 | 19.0 | 21.1 | 24141-5-12 | 24141RB8-5-12 | 241R36-5 | 24241-5-12 | 24241RB8-5-12 | 242R36-5 | 24M41-5-12* | |
| | 12-13 | 0.109-0.095 | 2.77-2.41 | 0.769 | 0.866 | 19.5 | 22.0 | 24143-5-12 | 24143RA8-5-12 | 241R39-5 | 24243-5-12 | 24243RA8-5-12 | 242R39-5 | 24M43-5-12* | |
| | 14 | 0.083 | 2.11 | 0.799 | 0.896 | 20.3 | 22.7 | 24144-5-12 | 24144RA8-5-12 | 241R41-5 | 24244-5-12 | 24244RA8-5-12 | 242R41-5 | 24M44-5-12* | |
| | 15-16 | 0.072-0.065 | 1.83-1.65 | 0.841 | 0.922 | 21.4 | 23.4 | 24145-5-12 | 24145RA8-5-12 | 241R41-5 | 24245-5-12 | 24245RA8-5-12 | 242R41-5 | 24M45-5-12* | |
| | 17-19 | 0.058-0.042 | 1.47-1.07 | 0.880 | 0.976 | 22.3 | 24.8 | 24146-5-12 | 24146RA8-5-12 | 241R42-5 | 24246-5-12 | 24246RA8-5-12 | 242R42-5 | 24M46-5-12* | |
| | 20-24 | 0.035-0.022 | 0.89-0.56 | 0.894 | 0.990 | 22.7 | 25.2 | 24147-5-12 | 24147RA8-5-12 | 241R43-5 | 24247-5-12 | 24247RA8-5-12 | 242R43-5 | 24M46-5-12* | |

Mandrel drive square size is 3/8". *Mandrel drive square size is 1/2". **Mandrel drive square size is 3/4".



24 SERIES EXPANDER

US FABRICATOR CUT COSTS & BOOSTED QUALITY

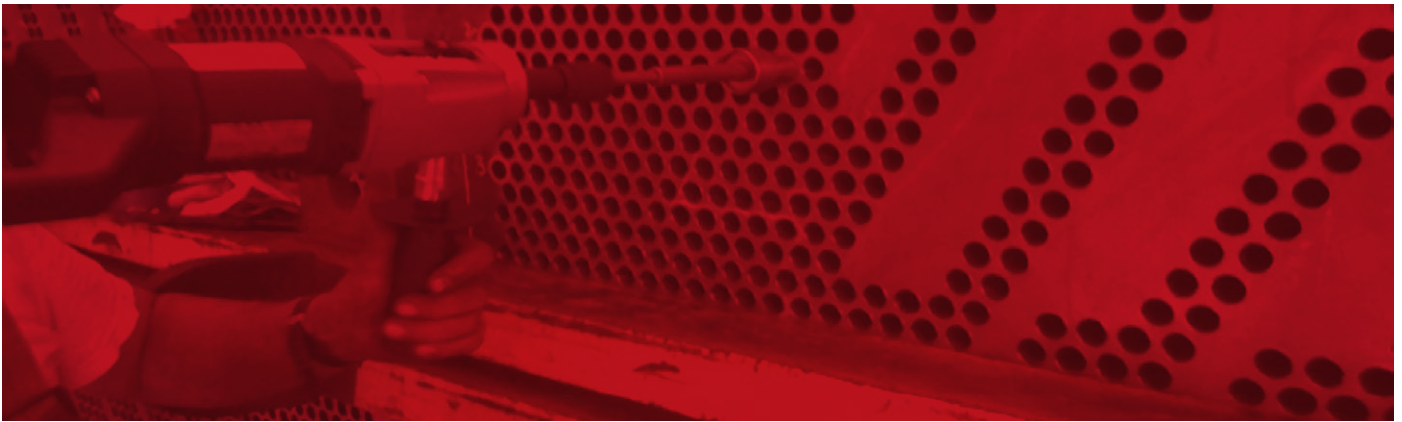

QUICK SUMMARY

The Challenge

- Provide a quality product to customers on time while controlling costs.
- Producing custom sized rolls to fit their application lead to inconsistencies in product.
- Halting production due to frequent tool breakage.

The Solution

- Tool life trial to compare Elliott's 24 Series to their current expander.

The Results

- The 24 Series increased performance enough to yield a 10% savings in labor time and costs.
- Significant increase in tool life and ease of use, reducing rework and hassles.

The Challenge

A major US fabricator provides a full range of heat transfer products and services. A large part of their business is providing, manufacturing, and servicing of heat transfer vessels such as heat exchangers, condensers, and feedwater heaters. Producing a quality product in a timely manner for customers is one of the company's primary objectives.

In order to save time and money while still ensuring satisfying results, operators need the right tool for the job and that tool must be able to last. Jim Damon, as a Lean Manufacturing Engineer, understands this statement, as he can personally relate to the challenges involved with using a tool that is not right for a particular job.

Jim and his team's current condenser expanders have rolls, which need to be customized by grinding them down in order to obtain the effective roll length required for their application. Jim was using a 5 roll expander without a thin wall collar. However, the rolls are not precisely machined, as the amount removed varies, giving different effective roll lengths even on the same expander. The lack of a thin wall collar can cause the tube to become jammed in the tube expander's flush thrust collar. Jim and his team also report expansion inconsistencies using these expanders. Due to the poor quality of the customizations, the rolls would constantly fall into the cage ID and get stuck. The operator constantly has to fix this.

In addition to using expanders whose quality could not match their needs, Jim and his team continually wanted an expander that could last longer and reduce their need for frequent replacement expanders or spare rolls and mandrels. The constant hassles, extra work, and rework were costing Jim and his team extra time and extra money. They were not satisfied with their current tools and were ready to make a change.

The Solution

Jim Damon and his team tested Elliott's new 24 Series Condenser Expanders on a nuclear power plant heat exchanger with titanium grade 2 welded tubes.

Elliott supplied a 24 Series condenser expander with nylon pilot, 5 rolls, and a thin wall collar. Jim and his team performed a side-by-side test of Elliott's 24 Series Expander versus the current expander brand they were using. During the 2-day visit, the operators expanded approximately 1,300 tube ends. Three expanders were used, and interchanged every ~30 tubes to keep them cool, clean, and lubricated.

Their initial impression of the expander and its design was extremely positive. They liked the design with the nylon pilot as well as the thin wall collar because of added

protection from tube scoring and jammed cages. Jim noticed the quality rolled joint from the 24 Series, and the target ID was hit accurately and consistently. The consistent numbers and impressive ease of use were Jim's favorite aspects of the Elliott brand expanders.

Jim and his team were very pleased to discover that the 24 Series Expanders resulted in a highly superior expansion and increased tool life. Just a few of the great benefits Jim experienced were:

- Quality rolled joints.
 - Decreased labor time, thus lower costs.
 - Minimal hassles using thin wall collars.
 - Less downtime with much faster, more efficient cleaning.
- After using Elliott's 24 Series, Jim found which tool he preferred. With the inconsistencies in the expansions and the constant hassle of fixing the stuck rolls gone, a winner was decided.

The Results

With Elliott's 24 Series, this fabricator experienced a significant increase in tool life and ease of use, which reduced rework, hassles, and improved productivity. Also, the nylon pilots greatly helped eliminate tube scratches. These benefits mean significant cost savings for them by switching to the 24 Series from their current expanders.



**Elliott's 24 Series
Tube Expanders have
excellent tool life.
They held consistent
rolled ID numbers and
are easy to adjust.
I'm purchasing more
immediately.**

**Jim Damon, Lean
Manufacturing Engineer**

In terms of specific results for Jim and his team, the 24 Series increased performance enough to yield a 10% savings in labor time. Equally, this translates to an impressive 10% savings in labor costs as well. This was directly caused by the eliminated time spent with replacing broken tools or reworking expansions. Essentially, the operators were able to work through continuously without having to stop and deal with hassles and problems.

Based on early results, increased tool life should cut tooling costs by about 35%. In addition to using less tools to complete the job, there is also increased productivity due to less time being spent on replacing tooling or removing broken tooling from the tube.

Jim Damon and his team were highly satisfied with the tool life and consistency of Elliott's 24 Series Condenser Expanders. Overall, he is now certain that the 24 Series is the superior tool, and he prefers Elliott's expanders to any others.

To learn if you can expect similar results from the 24 Series Expanders, contact your local support or Elliott Tool Technologies.

Benefits of Elliott's 24 Series

Key results achieved during tool life trial



6621 SERIES

Sugar Mill Vacuum Pan Expander

Tube Size

- 3.000" to 4.000" OD
- (76.2 to 101.6mm) OD

Elliott's 6621 Series Sugar Mill Vacuum Pan Expanders are ideal for the fabrication and re-tube of sugar mill vacuum pans.

They are operated from the top and eliminate the cumbersome and dangerous task of expanding the bottom tube sheet from underneath the pan. The 6621 Series Expanders also remove the need to purchase several short mandrels required for bottom tube sheet expansions.

6621 Short Expander Assembly For Rolling Top Sheet.



6621 Long Reach Expander Assembly For Rolling Bottom Sheet From Top Sheet.



Features & Benefits:

- Easy assembly and disassembly.
- Range for reach adjustment of up to 12" (304.8mm).
- Pin and washer mandrel retention.
- Through-hole for vertical suspension (fits standard "D" rings).
- Double radius rolls to avoid sharp edges on rolled area.
- Operator Friendly: less operator fatigue, safer than rolling from bottom.
- Less time resulting in significant labor cost savings.

6621 Series Sugar Mill Vacuum Pan Expander includes:

- Expander Assembly
- Cage Extension
- Mandrel Extension
- Mandrel Guide
- Square Socket
- 3 Set Screws

Spares & Accessories:

- Extension Set: Includes 1 Cage Extension, 1 Mandrel Extension, 1 Mandrel Guide, 1 Square Socket, and 3 Set Screws
- Roll Set
- Mandrel

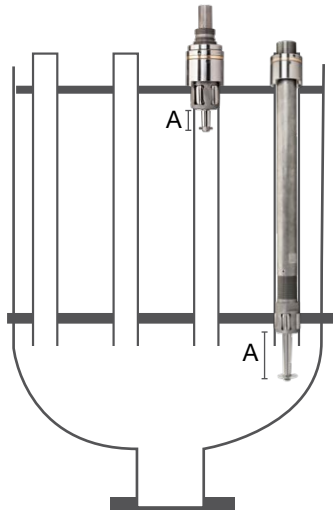

| Tube Size | Kit Part Number | 30"-42" Reach | 42"-54" Reach | 54"-66" Reach |
|----------------|-----------------|---------------|---------------|---------------|
| 3" x 14-16 | 6621-44-xx | 36 | 48 | 60 |
| 3-1/2" x 14-16 | 6621-53-xx | | | |
| 4" x 13-18 | 6621-60-xx | | | |

xx= Expander Reach

| Tube Sheet Thickness OD BWG | Range (min.-max.) | Expander Assembly | Roll Set (5 per set) | Spare Mandrel | Drive Shank | "A" Distance |
|--------------------------------|----------------------|----------------------|-------------------------|------------------|----------------|-----------------|
| 3" x 14-16 | 2.750 - 3.000 | 6621-44 | 662105-44-5 | 662103-44 | 3/4" Sq. | 6.10" |
| 3-1/2" x 14-16 | 3.250 - 3.500 | 6621-53 | 662105-53-5 | 662103-53 | 3/4" Sq. | 6.10" |
| 4" x 13-18 | 3.750 - 4.000 | 6621-60 | 662105-60-5 | 662103-60 | 1" Sq. | 6.10" |



3321 SERIES

Sugar Mill Vacuum Pan Expander

Tube Size

- 3.000" to 4.000" OD
- (76.2 to 101.6mm) OD



Elliott's 3321 Series Sugar Mill Vacuum Pan Expanders are the ideal expanders for re-rolling tubes in vacuum pans.

The 3321 Series Expanders can be used with short series mandrels for rolling in confined spaces.

Features & Benefits:

- For performing a straight roll operation or re-rolling leaky joints.
- Ball bearing thrust collar prevents force feed of expander into tube.
- High quality steel for the most demanding applications.

Mandrels are sold separately

Spares & Accessories:

- Short Series Mandrel: 6-1/4" (158.8mm) OAL with 1" (25.4mm) square drive. Both mandrels are required for the selected wall gauge.
- Roll Set

| Tube OD Size | BWG | Expansion Range | Expander Assembly | Roll Set | Drum Mandrel* | Short Mandrels | Weight |
|--------------|-------|-----------------|-------------------|----------|---------------|----------------------|--------|
| 3" | 13 | 2.687 - 3.000 | 3321-21116 | 3321-16A | 150003MD8PX | 150003N7, 150003N8 | 18 lbs |
| | 14-17 | | | | | 150003N9, 150003N10 | |
| | 18 | | | | | 150003N10 | |
| 3-1/2" | 13 | 3.187 - 3.562 | 3321-30316 | 3321-23A | 150003MD9PX | 150003N8, 150003N9 | 19 lbs |
| | 14-17 | | | | | 150003N10, 150003N11 | |
| | 18 | | | | | 150003N11, 150003N12 | |
| 4" | 13 | 3.625 - 4.000 | 3321-30508 | 3321-28A | 150003MD10PX | 150003N10, 150003N11 | 21 lbs |
| | 14 | | | | | 150003N12, 150003N13 | |
| | 15-17 | | | | | 150003N13, 150003N14 | |
| | 18 | | | | | 150003N14 | |

* Mandrels must be purchased separately.

** Roll Set includes 3 rolls and 6 roll retainer pins.



COLLET STYLE SUPPORT SHEET EXPANDERS

COLLET SUPPORT EXPANDERS

Tube Size

- 0.750" to 1.000" OD
- (19.1 to 25.4mm) OD

Elliott's Collet Style Support Sheet Expanders are used with a handheld short stroke hydraulic ram and lightweight, low-pressure hydraulic pump to support sheet expand finned or prime surface tubes commonly found in chillers. Suitable only for soft materials such as copper. Not suitable for all chiller applications, i.e. Duplex chillers which require rolled joints in a center tube sheet.

Elliott offers two packages for 3/4" (19.1mm) and 1" (25.4mm) tubes.

Features & Benefits:

- Expands copper tubes in support sheets in seconds
- Modular design allows for easy transport and storage

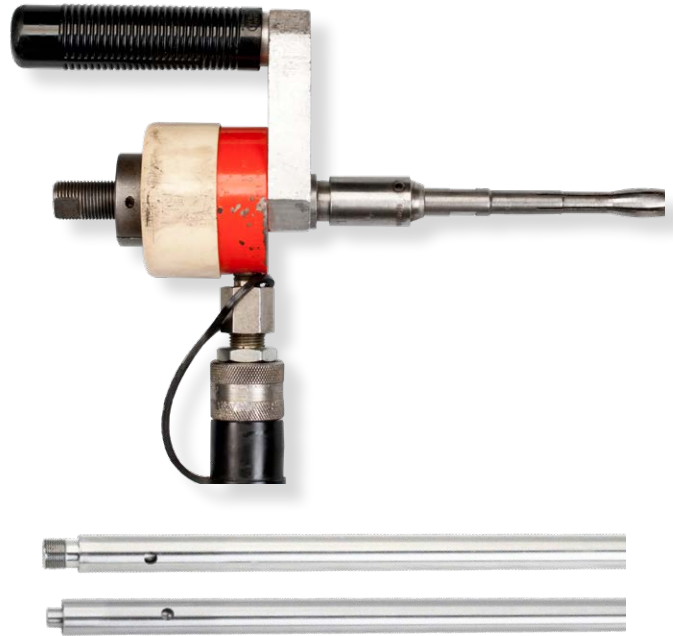

Collet Extensions

| Collet Style Support Sheet Expanders | | | | |
|--------------------------------------|--------------------------------------|-----------|----------------------|------------------|
| Tube OD | Expansion Range | Kit | Expander Part Number | Short Stroke Ram |
| 3/4" (19.1mm) | 0.530" - 0.687" (13.46 - 17.45mm) | B9765PKG | B9765A00 | M5766-00 |
| 1" (25.4mm) | 0.812" - 0.982" (20.62 - 24.94mm) | B10180PKG | B10180-00 | |

Standard package works up to 12 ft. For longer reach requirements, contact Elliott.

Rental Collet Style Support Sheet Packages:

- Collet Style Support Sheet Expander
- Short Stroke Hydraulic Ram
- M5816-00 Hydraulic Pump

Spares & Accessories:

- Draw Bar
- Draw Bar Extension: Each Draw Bar Extension will add 4 ft. (1.2M) to expander length
- Collet Extension: Each Collet Extension will add 4 ft. (1.2M) to expander length



TUBE EXPANDER ACCESSORIES

Drives



Universal Drive Handles



Drive Shaft



Socket

| | Part Number | Male Square Drive | Overall Length* | Socket | Side A | Side B | Width Across Face |
|-------------------------|-------------|-------------------|-----------------|--------|----------------------|----------------------|-------------------|
| | | | | | Female square Socket | Female square Socket | |
| Universal Drive Handles | 73UHX12 | 3/8" | 12" | 71SOX | 3/8" | 3/8" | 1-3/4" |
| | 73UHX20 | 3/8" | 20" | | | | |
| | 73UHT12 | 1/2" | 12" | 71SOXT | 3/8" | 1/2" | 1-7/8" |
| | 73UHT20 | 1/2" | 20" | | | | |
| | 73UHC12 | 3/4" | 12" | 71SOCX | 3/8" | 3/4" | 1-7/8" |
| | 73UHC20 | 3/4" | 20" | | | | |
| | 73UHM12 | 1" | 12" | 71SOT | 1/2" | 1/2" | 1-3/4" |
| 73UHM20 | 1" | 20" | | | | | |
| Drive Shaft | 73DST4 | 1/2" | 4" | 71SOCT | 1/2" | 3/4" | 1-7/8" |
| | 73DST8 | 1/2" | 8" | 71SOMT | 1/2" | 1" | 1-7/8" |
| | 73DST12 | 1/2" | 12" | | | | |
| | 73DST24 | 1/2" | 24" | 71SOBT | 5/8" | 1/2" | 1-3/8" |
| | 73DSC4 | 3/4" | 4" | | | | |
| | 73DSC8 | 3/4" | 8" | 71SOCB | 5/8" | 3/4" | 2" |
| | 73DSC12 | 3/4" | 12" | | | | |
| | 73DSC24 | 3/4" | 24" | 71SOMB | 5/8" | 1" | 2" |
| | 73DSM4 | 1" | 4" | | | | |
| | 73DSM8 | 1" | 8" | 71SOC | 3/4" | 3/4" | 2" |
| | 73DSM12 | 1" | 12" | | | | |
| | 73DSM24 | 1" | 24" | 71SOMC | 3/4" | 1" | 2" |
| | | | | | | | |
| | | | | 71SOM | 1" | 1" | 2" |

* Available in additional lengths

Drive shafts and sockets are used as a connection between two right angle gear drives.

Universal Joints



Universal Joint Drives



Series 1149 and 202

| | Part Number | Side A | Side B | | Overall Length |
|------------------------|-------------|----------------------|-------------------|----------------------|----------------|
| | | Female Square Socket | Male Square Drive | Female Square Socket | |
| Universal Joints | 72UJX1 | 3/8" | | 3/8" | 3" |
| | 72UJX2 | 3/8" | 3/8" | | |
| | 72UJT1 | 1/2" | | 1/2" | |
| | 72UJT2 | 1/2" | 1/2" | | 4" |
| | 72UJC3 | 3/4" | | 3/4" | |
| | 72UJC4 | 3/4" | 3/4" | | |
| | 72UJM7 | 1" | | 1" | 4-1/2" |
| | 72UJM8 | 1" | 1" | | |
| Universal Joint Drives | 72-1149XX | 3/8" | 3/8" | | 10" |
| | 72-1149TT | 1/2" | 1/2" | | 10" |
| | 72-1149CC | 3/4" | 3/4" | | |
| | 72-1149MM | 1" | 1" | | |
| | 72-202JMM | 1" | 1" | | 23" |



99 SERIES

Electric Rolling Motors

Tube Size

- 0.250" to 3.000" OD
- (6.4 to 76.2mm) OD



99062 Motor



99150 Motor

ALWAYS ON, ALWAYS PRECISE.

Electricity offers better consistency when rolling tubes and is more readily available than air. However, in the past, pneumatic rolling motors have offered higher RPMs and torque. Elliott is redefining the electric rolling motor with the 99 Series. Now, faster RPMs and comparable torque to pneumatic offerings are possible.

The dual speed option offers a new level of flexibility when rolling across various applications. The low speed setting offers increased torque for demanding applications while the high speed setting allows for greater speed and productivity.

To complement the 99 Series Electric Rolling Motors, Elliott offers the best electric torque controller in the market, the ELC110220. Job setup is 2 to 3 times faster and allows you to roll to the target ID each time so that costly re-rolls are eliminated.



99300 Motor

FOR
RENT

Features & Benefits:

- More consistent and convenient than pneumatic rolling motors.
- High RPMs for faster job completion.
- Dual speed: High gear for greater speed and productivity, low gear for high torque applications.
- Lightweight, balanced ergonomics for decreased operator fatigue.
- Ready for immediate use with the best electric torque controller in the market, Elliott's ELC110220.

| Tube OD Range* | | Part Numbers | Included Square Chuck | Included Tool Box | Carbon Brush Replacement Sets |
|----------------|---------------|--------------|-----------------------------|-------------------|-------------------------------|
| 1/4" - 5/8" | 6.4 - 15.9mm | 99062-110-7P | 1/4 & 3/8 Fem. Quick Change | 153G | 44-191627-8 |
| | | 99062-220-7P | | | |
| 1/2" - 1-1/2" | 12.7 - 38.1mm | 99150-110-7P | 3/8 & 1/2 Fem. Quick Change | 153G | 40-80700013-2 |
| | | 99150-220-7P | | | |
| 1" - 3" | 25.4 - 76.2mm | 99300-110 | 3/4 & 1 Fem. Socket | 153K | 40-80700021-2 |
| | | 99300-220 | | | |

*Tube size range may vary due to tube wall thickness, wall reduction, material, tube sheet thickness, lubrication, operating condition, and/or operator technique.

Please contact Customer Service if your application falls at the low or high end of the tube OD range listed to ensure the motor will work for your application.

| Motor | Voltage | Motor Type | Hz | Amps (Max.) | Free Speed RPM (No Load) | Maximum Torque (@ Max. Amps) | Approx. Weight (lbs/Kg) | Spindle Drive Size |
|--------------|---------|----------------|-------|-------------|-------------------------------------|--|-------------------------|--------------------|
| 99062-110-7P | 110 | Auto-Reverse* | 50-60 | 4.3 | 4,250 | 15 in.-lbs. @ 1,900 RPM | 2.7 / 1.2 | 3/8 Male Sq. |
| 99062-220-7P | 220 | | 50-60 | 2 | 4,000 | | | |
| 99150-110-7P | 110 | | 50-60 | 10 | 760 (Low Gear) 1,250 (High Gear) | 12 ft.-lbs. @ 290 RPM 8 ft.-lbs. @ 690 RPM | 8.5 / 3.9 | 1/2 Male Sq. |
| 99150-220-7P | 220 | | 50-60 | 5 | 760 (Low Gear) 1,250 (High Gear) | 12 ft.-lbs. @ 290 RPM 8 ft.-lbs. @ 690 RPM | | |
| 99300-110 | 110 | Manual Reverse | 50-60 | 16 | 75 (Low Gear) 250 (High Gear) | 102 ft.-lbs. @ 72 RPM 30 ft.-lbs. @ 244 RPM | 17 / 7.7 | 3/4 Male Sq. |
| 99300-220 | 220 | | 50-60 | 8 | 75 (Low Gear) 230 (High Gear) | 102 ft.-lbs. @ 72 RPM 30 ft.-lbs. @ 244 RPM | | |

*Auto-Reverse motors must be paired with Elliott's ELC110220.



Spares & Accessories:

- ELC110220 Electric Torque Controller. Required when using Elliott's "-7P" auto-reversing motors. *See page 64 for more information.*
- Motor Adapter Cord: *See page 217 for more information.*

FOR RENT

HOW TO SELECT THE RIGHT TUBE ASSISTED ROLLING SYSTEM

Many operators are challenged with completing a job correctly and on time. There are many factors that can influence a job outcome, such as tool life, operator error, and system productivity. One of the most effective ways to overcome these issues is through the use of an assisted tube rolling system.

KEY FEATURES OF ASSISTED SYSTEMS

Modern assisted systems come equipped with different features designed to enhance performance and reliability:

- **Torque Control:** Various types of torque control are used to accurately measure and control torque, allowing for consistent wall reduction with every roll. This precision is critical for eliminating rework and downtime.
- **Expander Holder and Articulated Arm:** An articulated arm and expander holder work together to securely support the motor and expander. This ensures proper tool alignment and prevents premature tool breakage often caused by axial load.
- **Auto-Lubrication:** This feature provides automatic expander lubrication to the working area of the tool, significantly increasing tool life and reducing downtime that would otherwise be spent lubricating tooling manually.

FACTORS FOR SYSTEM SELECTION

When purchasing an assisted tube rolling system, you should evaluate several factors to determine the best solution for your application: tube size, consistency, productivity, and ergonomics.

Tube Size

First, consider the tube size and materials you will be working with. While most systems cover a wide range, some are specifically designed for rolling smaller tubes, such as those found in oil coolers and small heat exchangers. These compact systems are also well-suited for confined or smaller workspaces.

Additionally, consider the tube material that you will be working with, as that will determine what torque range is required for the application. While a system may cover a range of tube sizes, the torque output could be more limiting.

Consistency

Next, examine the system's consistency. The primary goal of tube rolling is to achieve a sound mechanical tube-to-tube sheet joint. To ensure high-quality expansions, the tube wall must be reduced by a predetermined percentage that is consistent across every expansion. Maintaining this consistency drastically reduces the chance of tube leaks and costly rework later.

Assisted tube rolling systems offer significantly better consistency than manual rolling due to built-in torque control systems. While pneumatic motors offer speed, their consistency can suffer from fluctuations in air volume or pressure. To overcome this, many advanced systems utilize an electronic torque control unit that can regulate a motor regardless of its power source. An electronic torque control system is generally preferred for heat exchanger applications due to their increased precision and sensitivity.

Productivity

Productivity is also an important aspect of system selection. Using an assisted tube rolling system can significantly prolong tool life and boost overall job output. As mentioned, an expander holder ensures proper tool alignment and automatic tool lubrication extends the life of the expander—a particular advantage when working with vessels that have thick tube sheets or water boxes.

Beyond tool life, the system speed and rolling method is crucial for determining productivity. When considering cycle time, tooling change-out, and lost time due to rework, different expansion methods offer varying levels of efficiency:

1. Traditional Expansion(Good Option):

In traditional expansion, speed is defined by the rotation of the mandrel and its feed angle. Once expansion is complete, the mandrel rotation must be reversed to remove the expander. This forward and reverse can amount to a longer cycle time

2. Parallel Pin Rolling System(Better Option):

The expander is continuously rotated in one direction while the mandrel is independently pushed and pulled from the tube. This method reduces cycle times by 50% or more compared to traditional expansion.

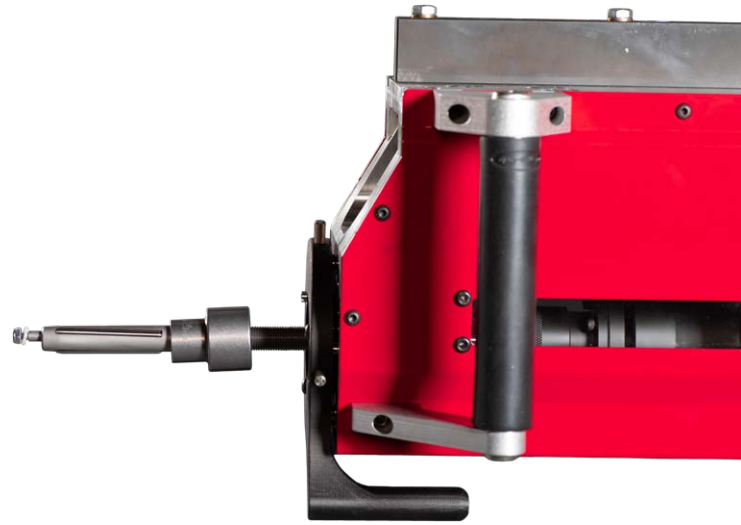
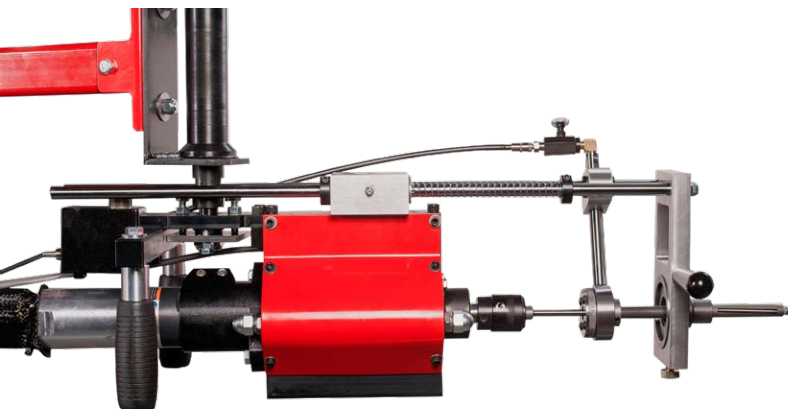

3. Combined System(Best Option):

While parallel pin expansion is highly efficient, a system that allows operators to switch between parallel and traditional expansion methods offers the greatest flexibility. Since parallel pin is not well suited for every heat exchanger application, a combined system decreases capital spending.

Ergonomics

Each system is equipped with features designed to reduce operator fatigue and stress when rolling. For instance, a counterbalance-type system can reduce the weight of the motor for the operator. However, most counterbalance systems do not absorb the motor's reaction torque, meaning the operator still takes on that force.

A better ergonomic solution is an articulated arm, which not only supports the motor's weight but also effectively absorbs its torque, allowing the operator to position and roll the motor with minimal effort. Ease of use is also a key ergonomic consideration, often achieved through automation. An auto-reverse system makes the expansion process easier by ensuring the motor rolls until it hits the set torque and then automatically reverses out of the tube

Taking this a step further, some advanced systems are equipped with auto-cycling, which allows the operator to simply turn the system on, and it will start, stop, and reverse without any further manual intervention. These features collectively contribute to a safer, less physically demanding, and more efficient rolling process.

CONCLUSION

Assisted tube rolling systems are an excellent investment for increasing productivity and decreasing operating costs. By carefully considering tube size, consistency, productivity, and ergonomics, you can choose the system that provides the optimal solution for your facility.

ELC110220

Electric Torque Controller

ELECTRIC TORQUE CONTROLLER



JOB SETUP 2 TO 3 TIMES FASTER.

Elliott is pleased to introduce its ELC110220 Electric Torque Controller – the first torque control with an Embedded Logic Controller that senses and is compatible with both 110V and 220V and automatic and manual reverse rolling motors.

Setup is easy and two to three times faster, even for inexperienced operators. You can choose one of three modes: automatic, assisted, or manual to suit your individual rolling needs.

Whereas other competitors require two or more torque controls to accommodate different rolling motors or voltages, the ELC110220 can be used with auto or manual reverse motors, 110V or 220V. No more worrying about which controller or motor to bring to the job site because the ELC110220 is all you need!

Additionally, the torque controller is CE Mark and UL & RoHS compliant for operator safety.



ELC110220

Electric Torque Controller

Features & Benefits:

- Job setup 2 to 3 times faster.
- Three setup modes to suit your needs.
- A single controller lowers your investment.

Specifications:

- Amperage: 20 Amps
- Hertz: 50 / 60 Hz
- Voltage: 100V to 240V
- Tolerance: +/- 40 milliamps.
- Temperatures: 0°F to 120°F. (-18°C to 49°C)
- Dimensions: 8" x 6.5" x 6.75". (20.3 cm x 16.5 cm x 17.1 cm)
- Weight: 3.6 pounds (1.6 kg)
- Supported Languages: English, Spanish

ELC110220 Electric Torque Controller includes:

- Electric Controller Unit
- 110V North American (Nema 5-15) Controller Power Cord

Spares & Accessories:

- Replacement Controller Power Cords
- Electric Rolling Motors: For use with the ELC110220
- Motor Adapter Cord: Detachable adapter cords to adapt an existing electric motor(s) to the ELC110220 controller's 7-pin connection. Each adapter cord will measure approximately 1 ft. [0.3M] long. Auto-reversing motors must be of Elliott Tool manufacture. Motor Adapter Cords are available in the following:
 1. 110V North American (Nema 5-15) - Manual Reversing
 2. 110V North American (5-Pin Amphenol) - Auto Reversing
 3. 220V Continental Europe (Schuko) - Manual Reversing
 4. 220V Continental Europe (5-Pin Amphenol) - Auto Reversing
 5. 110V United Kingdom - Manual Reversing

Contact Customer Service for other manufacturers' auto-reversing models.

| Rolling Motors | | | | |
|----------------|---------------|----------------|---------------|----------------|
| Tube Size | 110V | | 220V | |
| | Auto Reverse* | Manual Reverse | Auto Reverse* | Manual Reverse |
| 1/4 – 5/8" | 99062-110-7P | - | 99062-220-7P | - |
| 1/2" – 1-1/2" | 99150-110-7P | | 99150-220-7P | |
| 1 – 3" | - | 99300-110 | - | 99300-220 |

**Auto-Reverse motors require the use of Elliott's ELC110220.*

| Item | Part Number |
|---|-------------|
| Electric Torque Controller | ELC110220 |
| Adapter Cord (220V Manual Cont. Eur.) | ELCACEU |
| Adapter Cord (220V Auto Cont. Eur.) | ELCACEUR |
| Adapter Cord (110V Manual NA) | ELCACNA |
| Adapter Cord (7 Pin M to 5 Pin F) | ELCACNAR |
| Adapter Cord (110V UK) | ELCACUK110 |
| Adapter Cord (7 Pin to 220V Cont. Eur. Non-Reverse) | ELCAC7PEU |
| Adapter Cord (7 Pin to 110V NA Non-Reverse) | ELCAC7PNA |
| Adapter Cord (5 Pin M to 7 Pin F) | ELCAC5P7P |
| Power Cord (Continental Europe) | ELCPCEU |
| Power Cord (North American) | ELCPCNA |
| Power Cord (United Kingdom) | ELCPCUK110 |



ET SERIES

Torque Controlled Pneumatic Rolling Motors

Tube Size

- 0.250" to 1.250" OD
- (6.4 to 31.8mm) OD

THE QUALITY YOU NEED. THE COMPATIBILITY YOU WANT.

Elliott offers the ET Series for tube sizes 1/4" (6.40mm) to 1-1/4" (31.8mm) to suit your tube expansion needs.

The ET Series Motors are torque controlled and ideal for rolling tubes in heat transfer vessels, ranging in size from small oil coolers to large heat exchangers.

The ET Series Motors have undergone extensive testing, proving long tool life and quality. Parts are truly compatible with the original Airetool® motors for convenient maintenance of existing motors. Elliott also offers repair services for existing Airetool® motors.

Two series to suit your application

Both ET series use torque actuated cams to measure torque and provide consistent expansions each time.



ET720

See page 67

Ergonomic & lightweight design is ideal for rolling small tubes commonly found in oil coolers and other small heat exchangers.

- Tube OD Range: 1/4" - 1/2" (6.4 - 12.7mm)
- Torque Range: 2 - 75 in lbs (0.23 - 8.5 Nm)

ET850

See page 68

Offering the same USA quality and performance you're used to with additional features to improve the operator experience.

- Tube OD Range: 3/4" - 1-1/4" (19.1 to 31.8mm)
- Torque Range: 22 - 318 in lbs (2.5 - 35.9 Nm)



Fast and consistent method for rolling small tubes.

Lightweight & ergonomic design is ideal for rolling small tubes commonly found in oil coolers and other small heat exchangers.

These motors work great with Elliott's 23 Series expanders. Backed by US quality and proven tool life, the 23 Series and ET720 motors consistently expand tubes in smaller vessels.



ET SERIES



Roll Every Tube To Spec



Ergonomic Handle Design

Consistent Tube Expansion

Roll Every Tube To Spec

Torque actuated cams accurately measure torque to provide consistent expansions each time.

Less Operator Fatigue

Lightweight aluminum core reduces operator fatigue.

Highly Durable

Rugged carbon fiber infused handle is designed to improve ergonomics and provide long tool life.

Operator Friendly

Ergonomic Design

Insulated handle doesn't get cold while you use it.

Easy To Use

Simply connect to the air supply, adjust torque, and start rolling.

Spares Kit Includes:

- Paddle Set
- O-Rings
- Radial Ball Bearings

Accessories:

- 1/4" Quick Change Chuck, ET720-025-037
- 3/8" Quick Change Chuck, ET720-037-037
- Spares Kit
- Filter-Lubricator, 6090

| Tube OD Range | Motor | Free Speed RPM | Torque Range | Weight | Air Usage | Air Supply Hose | Male Spindle Drive | Standard Quick Change Chuck | Spares Kit |
|------------------------------|----------------------------------|----------------|----------------------------------|--------------------|-----------------------|-----------------|--------------------|-----------------------------|------------|
| 1/4" - 3/8" (6.4 - 9.5mm) | ET720-2500 | 2,500 | 2 - 20 in lbs (0.23 - 2.6 Nm) | 2.4lbs (1.09kg) | 17 cfm (481 l/min) | 3/8" (9.5mm) | 1/4" (6.4mm) | 1/4" Fem Sq. | ET720SK-1 |
| | ET720-1800 | 1,800 | 2 - 27 in lbs (0.23 - 3.1 Nm) | | | | | 3/8" Fem Sq. | |
| ET720-1800-037 | 2 - 75 in lbs (0.23 - 8.5 Nm) | | 3/8" Fem Sq. | | | | | ET720SK-2 | |

*Tube size range may vary due to tube wall thickness, material, tube sheet thickness, lubrication, operation condition, and/or operator technique.



ET850 SERIES

Torque Controlled Pneumatic Rolling Motors

The next generation of push pull motors

Elliott's ET850 Motor is the next evolution of push-pull motors. Offering the same USA quality and performance you're used to, the compatibility you need, with additional features to improve the operator's experience.

A Motor You Can Count On

Roll Every Tube To Spec

Torque actuated cams measure torque to provide consistent expansions each time. Reference marks make it easy to roll to the same torque each time.

No Mess

Adjustable muffler port stays where you point it, keeping oil from getting on the operator.

Multi-Position Design

Multi-position muffler works as a handle and allows the operator to easily hold the motor in three different positions, left, right, and underneath.

Operator Friendly

Reduce Fatigue

An eye-bolt allows the operator to easily connect to a counterbalance, reducing fatigue.

Easy Setup

Includes quick disconnect air fitting to get the motor up and running quickly.

Accessories:

- 1/2" Quick Change Chuck, 810-050-037
- 3/8" Quick Change Chuck, 810-037-037
- Spares Kit
- Filter-Lubricator, 6070

Spare Kit Accessories:

- Paddle Set
- Trip Spring
- Radial Ball Bearing
- O-Rings



Roll Every Tube To Spec



Multi-Position Handle Design



Eye-Bolt Connects To A Counterbalance

| Tube OD Range | Motor | Free Speed RPM | Torque Range | Weight | Air Usage | Air Supply Hose | Male Spindle Drive | Standard Quick Change Chuck | Spares Kit |
|--------------------------------|------------|----------------|-------------------------------------|------------------|------------------------|-----------------|--------------------|---|------------|
| 5/8" - 3/4" (15.9 - 19.1mm) | ET850-1250 | 1,100 | 1.8 - 9.6 ft.lbs (2.5 - 13.0 Nm) | 11lbs (5.0kg) | 48 cfm (1274 l/min) | 1/2" (12mm) | 3/8" (9.5mm) | 3/8" Fem Sq (optional 1/2" available) | ET850SK-1 |
| 3/4" - 1" (19.1 - 25.4mm) | ET850-600 | 500 | 2.6 - 16 ft.lbs (3.5 - 21.7 Nm) | | | | | | ET850SK-2 |
| 1" - 1-1/4" (25.4 - 31.8mm) | ET850-400 | 400 | 5 - 26.5 ft.lbs (6.8 - 35.9 Nm) | | | | | ET850SK-2 | |

*Tube size range may vary due to tube wall thickness, material, tube sheet thickness, lubrication, operation condition, and/or operator technique.



MIDI/MAXI SERIES

Torque Controlled Pneumatic Rolling Motors

MIDI/MAXI SERIES

Tube Size

- 0.750" to 2.000" OD
- (19.1 to 50.8mm) OD

Elliott offers the Midi/Maxi™ Series for tube sizes 0.750" (19.1mm) to 2.000" (50.8mm) to suit your tube expansion needs.

The Midi/Maxi Series Pneumatic Rolling Motors are actually back by popular demand! Numerous customers requested that the Midi/Maxi Series be brought back, claiming they were the best motors on the market. These motors are manufactured with quality materials to provide motor robustness and durability for years. The Midi/Maxi Series Pneumatic Rolling Motors will last for years to come – they are so durable that they can survive for as long as thirty years or more.

Features & Benefits:

- Designed for maximum durability with heavy duty planetary gearing, roller and ball gearing construction, and Heli-Coil inserts.
- Customer proven that motors can survive for thirty years or longer.
- Exhaust hose, motor speed, and compact design provide increased operator satisfaction.
- High torque consistency reduces costs associated with rework.

Midi/Maxi Series Package includes:

- Torque Controlled Pneumatic Rolling Motor
- 16 oz. Can Lube Oil
- 7-1/2' Air Hose Whip
- Carrying Box
- Exhaust Hose Assembly
- Filter-Lubricator
- Hose Adapter
- Muffler Unit
- Quick Change Chucks
- Side Handle

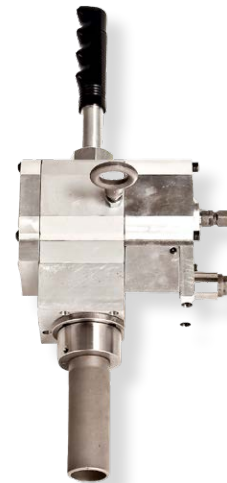

9017



9018

| | | 9017 Super Maxi-Torq | 9018 Super HD Maxi |
|------------------------------------|------------|--|---|
| Tube OD Range* | | 3/4" – 1-1/2" (19.1-38.1mm) | 1-1/2" – 2" (38.1-50.8mm) |
| Free Speed RPM | | 850 | 175 |
| Torque Range | | 12 – 33 ft lbs (16.3 – 44.7 Nm) | 30 – 150 ft lbs (40.7- 203.4 Nm) |
| Weight | lbs | 21 | 23 |
| | kg | 9.5 | 10.4 |
| Air Usage | | 75 cfm (2124 l/min) | 75 cfm (2124 l/min) |
| Air Supply Hose | | 3/4" (19mm) | 3/4" (19mm) |
| Male Spindle Drive | | 1/2" | 1" |
| Standard Quick Change Chuck | | 1/2" Fem. Sq. (1/2", 3/8", & 3/4" included in package) | 3/4" Fem. Sq. (3/4" & 1" included in package) |



*Tube size range may vary due to tube wall thickness, material, tube sheet thickness, lubrication, operation condition, and/or operator technique.

WHY THE RIGHT MOTOR MATTERS

THE CRITICAL ROLE OF TORQUE IN TUBE EXPANSION



FOR YEARS, tube expansion relied heavily on the subjectivity of “rolling to size or feel”. The issue is that what one operator “sees, hears, or feels” could drastically differ from another, leading to variability and a high potential for error. The advent of torque control revolutionized this process, significantly reducing operator error and ensuring consis-

tent, repeatable results across the board. While torque control is essential for consistency, the success often hinges on one critical factor: selecting the right motor for the job. Understanding why torque matters and the potential pitfalls of choosing the wrong motor is crucial for achieving reliable and lasting tube to tube sheet joints.

THE NUANCES OF TORQUE CALCULATION

The torque required for successful tube expansion isn't a one-size-fits-all value; it takes several key variables into account. While the tube's outer diameter (OD) and wall thickness are fundamental, the yield strength of the tube material, desired amount of expansion, and the effective roll length of the expander also play a large role.

These additional variables can make a big difference in expansion. For example, the torque needed to expand a 1" x 14 BWG Carbon Steel tube in a 1" tube sheet will be significantly different from the torque required for 1" x 14 BWG Stainless Steel. While Stainless Steel has a higher yield strength, the wall reduction percent could mean a lower torque requirement. It will all depend on the application and the manufacturer requirements.

This inherent variability is why torque guides and reference sheets often present a wide range of specifications. Numerous factors influence the optimal torque, which

means you can't always go off the recommended Tube OD on a chart. Instead, it's important to understand the specifics of the application prior to selecting tooling.

The Impact of Incorrect Motor Selection

Choosing a motor with insufficient or excessive torque can lead to a cascade of problems, compromising the integrity and longevity of the expanded tubes.

RPM vs. Torque

The first crucial concept to understand is the inverse relationship between RPM and torque. A single motor cannot excel at both ends of the spectrum. High RPMs are generally suitable for expanding small, thin-walled tubes where the resistance and torque requirement are low. Conversely, heavier wall tubes or applications involving thick tube sheets or drum walls necessitate significantly more torque to effectively move the material. This increased torque demands slower rotational speeds.

Insufficient Torque: The Struggle for Expansion

If the selected motor lacks the necessary torque, it simply won't be able to achieve the desired expansion target. Operators might be tempted to compensate by repeatedly rolling the same tube to reach the target ID. However, this repeated working of the material leads to work hardening. The tube becomes increasingly brittle and resistant to further deformation. Eventually, it will reach a point where no further expansion is possible, resulting in a poor joint that will likely fail hydro testing.

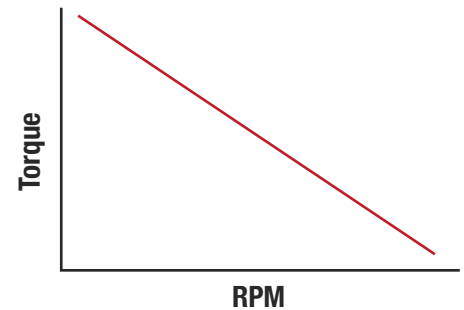

Best Practices for Torque-Controlled Expansion

Even with the correct motor, adhering to best practices is essential for consistent and reliable results:

Pneumatic Motor Considerations: For pneumatic motors, which offer less precise torque measurement compared to electronic systems, it's advisable to keep detailed records of the torque achieved at each reference mark on the motor. This provides valuable data for future jobs and troubleshooting.

Start Low and Adjust: It's always recommended to begin the rolling process with a torque setting that is 1-2 foot-pounds below the recommended target. This approach allows for incremental increases. Remember, you can always increase the torque, but you cannot reverse expansion.

Expand and Verify: The proper procedure involves rolling a tube, measuring the finished ID, adjusting the torque setting as needed, and then rolling the next tube. This iterative process, with ID checks after each adjustment, ensures accuracy. Once the target ID is achieved, previous tubes can be re-rolled to hit target.

Regular Monitoring: Once a job com-

mences, it's important to periodically check the finished ID – ideally every 25-50 expansions. This helps identify any potential change in motor performance or other factors that might be influencing the expansion process.

Excessive Torque: The Risk of Over-Expansion

Conversely, selecting a motor with significantly more torque than required can be equally damaging. For instance, if an application demands 7.5 foot-pounds of torque, but the available motor has a minimum threshold of 10-20 foot-pounds, the motor won't register the lower resistance. It will continue to apply force until it reaches its minimum output, leading to over-expansion.

Over-expanded tubes can become elongated and severely work-hardened. While they might initially pass a hydro test, their long-term performance and durability are compromised. These over-stressed tubes are prone to failure under operational stresses, potentially leading to premature replacement or the need for plugging after only a few months of service. This results in costly downtime and repairs.

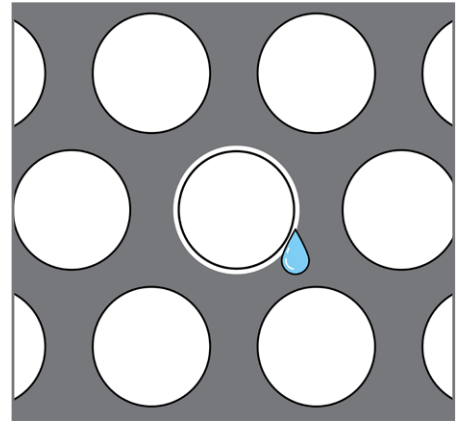

Result of under-rolling

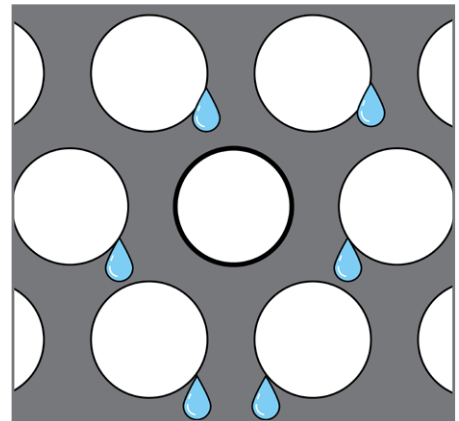

Result of over-rolling

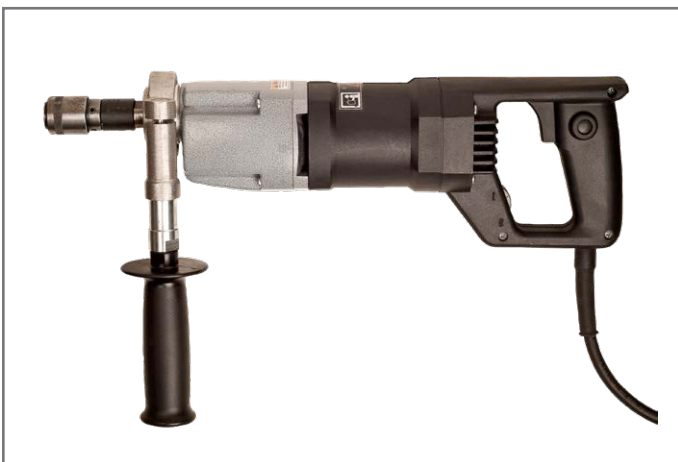

Electric Rolling Motor



Pneumatic Rolling Motor

Ensuring Optimal Motor Selection

To mitigate these risks and ensure the best possible outcome, it is crucial to collaborate closely with your equipment supplier. Providing them with detailed information about your specific application – including the tube's OD, wall thickness, material type, and the desired expansion length – will enable them to recommend the most appropriate motor for the job.

Best Practices for Torque-Controlled Expansion

Even with the correct motor, adhering to best practices is essential for consistent and reliable results:

- **Pneumatic Motor Considerations:** For pneumatic motors, which offer less precise torque measurement compared to electronic systems, it's advisable to keep detailed records of the torque achieved at each reference mark on the motor. This provides valuable data for future jobs and troubleshooting.
- **Start Low and Adjust:** It's always recommended to begin the rolling process with a torque setting that is 1-2 foot-pounds below the recommended target. This approach allows for incremental increases. Remember, you can always increase the torque, but you cannot reverse expansion.
- **Expand and Verify:** The proper procedure involves rolling a tube, measuring the finished ID, adjusting the torque setting as needed, and then rolling the next tube. This iterative process, with ID checks after each adjustment, ensures accuracy. Once the target ID is achieved, previous tubes can be re-rolled to hit target.
- **Regular Monitoring:** Once a job commences, it's important to periodically check the finished ID – ideally every 25-50 expansions. This helps identify any potential change in motor performance or other factors that might be influencing the expansion process.



CONCLUSION

In conclusion, torque is not merely a setting on a motor; it is the fundamental force that dictates the success of the expansion process. Choosing the wrong motor, one that either lacks sufficient power or delivers excessive force, can lead to a host of problems, including inadequate expansion, work hardening, over-expansion, and ultimately, premature tube failure. By understanding the nuances of torque calculation and collaborating with suppliers, operators can effectively utilize torque control to achieve consistent, reliable, and long-lasting tube joints. The investment in the right motor and adherence to best practices are essential for ensuring the integrity and efficiency of heat transfer vessels.

445 SERIES

Right Angle Pneumatic Motors

Tube Size

- 1.500" to 4.000" OD
- (38.1 to 101.6mm) OD



The quality you need. The compatibility you want.

Elliott offers the 445 Series Motors in both roll and lever throttle for tube sizes 2.000" (50.8mm) to 4.000" (101.6mm) to suit your tube expansion needs.

The powerful 445 Series Motors are ideal for tough boiler tube applications. The right angle heads are suited for rolling tubes in hard to reach, tight areas. Available in torque controlled & stall type motors.

The 445 Series Motors have undergone hundreds of hours of rigorous testing, proving tool life and ensuring quality. Motor parts are designed to truly be compatible with Cleco® and Airetool® motors, for convenient maintenance of existing motors.

Features & Benefits:

- Powerful for boiler tube expansion.
- High quality proven design for long-lasting tool life.
- Right angle head enables rolling in hard to reach or tight areas.
- Parts are truly compatible with Cleco® and Airetool® for convenient maintenance of existing motors.



Roll Tubes In Tight Spaces



Operator Friendly Controls



Visit Our YouTube Channel To See the 445 Series in action!

www.youtube.com/elliott-tool



445 SERIES

Right Angle Pneumatic Motors

445 SERIES

Spares & Accessories:

- Spares Kit (445SK & 445SK-ST)
Includes O-Rings, Paddles, Muffler, Bearings, Bearing Seat Tool, Hex drive, Locknut and Spring*
- 6070 Filter-Lubricator
- Sockets, *see page 77*
- Chucks, *see page 77*

*Torque Controlled motor only

445 Series Package includes:

- Pneumatic Motor
- Torque Reaction Bar
- Socket
- Torque Adjusting Tool*
- Grease Fitting

*Torque Controlled motor only

Protect and maintain your tool's performance with the Elliott Tool 6070 Filter/Lubricator!



Torque Reaction Bar



6070 Filter/Lubricator and 16oz Pneumatic Oil 900082P (Purchased Separately)



| | Torque Controlled | | | | Stall Type | | | | | |
|------------------------------|----------------------------------|--------------|------------------------------------|-------------|--------------------------------|----------------|-----------------------------|---------------|------------------------------------|----------------|
| | 445L1753-190 | 445R1753-190 | 445L1752-90 | 445R1752-90 | 445L1753-190ST | 445R1753-190ST | 445L1752-90ST | 445R1752-90ST | 445L1550-100ST | 445R1550-100ST |
| Tube OD Range* | 1-1/2" - 3" (38.1 - 63.5mm) | | 2" - 4" (50.8 - 101.6mm) | | 1-1/2" - 3" (38.1 - 63.5mm) | | 2" - 4" (50.8 - 101.6mm) | | 1-1/2" - 2-1/2" (38.1 - 63.5mm) | |
| Free Speed RPM | 190 | | 90 | | 190 | | 90 | | 100 | |
| Torque Range** | 70 - 140 ft lbs (95 - 190 Nm) | | 150 - 305 ft lbs (200 - 410 Nm) | | 155 ft lbs Max (210 Nm) | | 325 ft lbs Max (440 Nm) | | 175 ft lbs Max (237 Nm) | |
| Throttle Type | Lever | Roll | Lever | Roll | Lever | Roll | Lever | Roll | Lever | Roll |
| Weight | 20 (9.0kg) | | 22 (9.9kg) | | 17 (7.7kg) | | 19 (8.6kg) | | 13 lbs (5.9kg) | |
| Air Usage | 70 cfm @ 90 PSI | | | | | | | | 55 cfm | |
| Air Supply Hose | 3/4" (19.05mm) | | | | | | | | 1/2" (12.7mm) | |
| Spindle Drive Size | 5/8" Sq. Male | | 3/4" | | 5/8" Sq. Male | | 3/4" | | 5/8" Sq. Male | |
| Standard Drive Socket | 3/4" Fem. Sq. | | 1" Fem. Sq. | | 3/4" Fem. Sq. | | 1" Fem. Sq. | | - | |

*May vary due to tube wall, material, and tube sheet thickness.

**Measured using industry standard Hard Joint Torque.



STALL TORQUE PNEUMATIC ROLLING MOTORS

PNEUMATIC ROLLING MOTORS

Tube Size

- 0.750" to 6.000" OD
- (19.1 to 152.4mm) OD

Elliott's Stall Torque Pneumatic Rolling Motors are the most powerful motors available for rolling tubes in extreme applications. The motors are recommended for use in heavy wall, thick drum applications in watertube boilers. 950 ft. lbs. of stall torque will expand any boiler tube with a wall thickness heavier than 8 BWG.

Features & Benefits:

- Ideal for expanding tubes with heavy wall thicknesses.

Spares & Accessories:

- 6080 Lubricator
- Morse Taper Adapters
- Sockets
- Chucks



| Tube OD Range* | | Part Numbers | Stall Torque | | Free Speed RPM | Weight | | Air Supply Hose | Air Usage (CFM @ 90 PSI) | Spindle Drive Size | Std. Drive Socket |
|----------------|---------|--------------|--------------|------|----------------|--------|------|-----------------|--------------------------|---------------------|-------------------|
| Inch | mm | | ft lbs | Nm | | lbs | kg | | | | |
| 3/4 - 1-1/2 | 19-38 | 440LA | 56 | 75 | 350 | 15 | 6.8 | 3/4" | 55 | 2MT Socket Fem. Sq. | 3/4" Fem. |
| 2 - 4 | 50-100 | 445SA | 275 | 365 | 150 | 45 | 20.4 | 1" | 100 | 4MT Socket Fem. Sq. | 3/4" Fem. |
| 4 - 6 | 100-150 | 445RA** | 950 | 1260 | 70 | 70 | 31.8 | 1" | 160 | 5MT Socket Fem. Sq. | 1" Fem. |

* May vary due to tube material, tube sheet thickness or tube wall thickness.

** Available for rent



ROLLING MOTOR ACCESSORIES

Connectors

Elliott offers many sizes and varieties of connectors that will allow you to quickly and easily attach your rolling motor and expander.

These connectors include Quick Change Chucks, Drive Sockets, and Morse Taper Adapters.



Female Square Both Ends

| Quick Change Chucks | | |
|---------------------|-------------------------|-------------------------|
| Part Number | Expander End Female Sq. | Motor Drive Sq. or M.T. |
| 810-025-037 | 1/4" | 3/8" |
| 810-037-037 | 3/8" | 3/8" |
| 810-037-050 | 3/8" | 1/2" |
| 810-050-050 | 1/2" | 1/2" |
| 810-050-075 | 1/2" | 3/4" |
| 810-075-050 | 3/4" | 1/2" |
| 810-075-075 | 3/4" | 3/4" |
| 810-075-100 | 3/4" | 1" |
| 810-100-075 | 1" | 3/4" |
| 810-100-100 | 1" | 1" |



Female Square To Male Square

| Quick Change Chucks | | |
|---------------------|-------------------------|-------------------------|
| Part Number | Expander End Female Sq. | Motor Drive Sq. or M.T. |
| 820-075-075 | 3/4" | 3/4" |
| 820-075-100 | 3/4" | 1" |
| 820-100-075 | 1" | 3/4" |
| 820-100-100 | 1" | 1" |



Female Square To Male Morse Taper

| Quick Change Chucks | | |
|---------------------|-------------------------|-------------------------|
| Part Number | Expander End Female Sq. | Motor Drive Sq. or M.T. |
| 830-00-2-037 | 3/8" | #2 MT |
| 830-00-2-050 | 1/2" | #2 MT |
| 830-00-2-075 | 3/4" | #2 MT |
| 830-00-3-037 | 3/8" | #3 MT |
| 830-00-3-050 | 1/2" | #3 MT |
| 830-00-3-075 | 3/4" | #3 MT |
| 830-00-3-100 | 1" | #3 MT |
| 830-00-4-075 | 3/4" | #4 MT |
| 830-00-4-100 | 1" | #4 MT |
| 830-00-5-075 | 3/4" | #5 MT |
| 830-00-5-100 | 1" | #5 MT |



Female Square Both Ends
(Ball Retention Both Ends)

| Quick Change Chucks | | |
|---------------------|-------------------------|-------------------------|
| Part Number | Expander End Female Sq. | Motor Drive Sq. or M.T. |
| 858400-1/4 | 1/4" | 1/2" |
| 858400-3/8 | 3/8" | 1/2" |
| 858400-1/2 | 1/2" | 1/2" |
| 858400-3/4 | 3/4" | 1/2" |
| 858400-1 | 1" | 1/2" |
| 902200-3/4 | 3/4" | 1" |
| 902200-1 | 1" | 1" |



Female To Female Square
(Set Screw Both Ends)

| Drive Sockets | | |
|---------------|-------------|--------|
| Part Number | Size | OAL |
| 71SOX | 3/8" x 3/8" | 1-3/4" |
| 71SOXT | 3/8" x 1/2" | 1-7/8" |
| 71SOCX | 3/8" x 3/4" | 1-7/8" |
| 71SOT | 1/2" x 1/2" | 1-3/4" |
| 71SOCT | 1/2" x 3/4" | 1-7/8" |
| 71SOMT | 1/2" x 1" | 1-7/8" |
| 71SOBT | 5/8" x 1/2" | 1-5/8" |
| 71SOCB | 5/8" x 3/4" | 2" |
| 71SOMB | 5/8" x 1" | 2" |
| 71SOC | 3/4" x 3/4" | 2" |
| 71SOMC | 3/4" x 1" | 2" |
| 71SOM | 1" x 1" | 2" |



Male Morse Taper To Male Square

| Morse Taper Adapters | | |
|----------------------|------------------|-------------|
| Part Number | Male Morse Taper | Male Square |
| 830-12-2-037 | #2 MT | 3/8" |
| 830-12-2-050 | | 1/2" |
| 830-12-2-075 | | 3/4" |
| 830-12-3-050 | #3 MT | 1/2" |
| 830-12-3-075 | | 3/4" |
| 830-12-3-100 | | 1" |
| 830-12-4-075 | #4MT | 3/4" |
| 830-12-4-100 | | 1" |
| 830-12-5-075 | #5MT | 3/4" |
| 830-12-5-100 | | 1" |



THREE SERIES TO MEET DEMANDING PRODUCTION SCHEDULES

Engineered with productivity and precision in mind, Elliott's assisted tube rolling systems complete the job right the first time. The Hawk's articulated arm supports the weight and absorbs the torque of the rolling motor using a pneumatic counterbalance, which allows the operator to effortlessly move the motor into position.



Table Hawk

See page 80

Designed to expand small tubes commonly found in oil coolers and other small heat exchangers.



Rapid Hawk

See page 84

Offers a pneumatic motor with electric torque control, suitable for Fab Shops & OEMs.



Ultra Hawk

See page 92

The speed and productivity of an electric servo motor with the capability to perform parallel pin and traditional expansion.



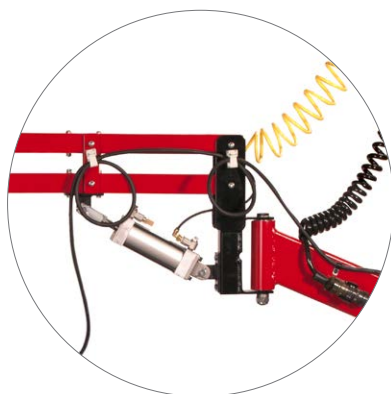

Effortless Positioning

Safe & Ergonomic

Supports Tool Weight

Pneumatic Counterbalance decreases operator fatigue by absorbing torque and allowing effortless positioning of the arm & rolling motor.

Effortless Positioning

The Articulated Arm increases operator ergonomics and decreases operator fatigue by supporting tool weight.

More Reach, Less Re-Adjusting

Large radial reach increases productivity by allowing a large area of tubes to be rolled without re-adjusting the unit.

Built-in Safety Features

Safety Control Valve protects the operator by eliminating a sudden drop of the articulated arm in case of pneumatic air loss.

Works Great In Smaller Work Spaces

Weighted Pedestal allows for convenient placement, even in a small workspace, with its compact design and small footprint.

Quick & Easy Setup

Get Up & Running Quickly

Fully assembled articulated arm minimizes setup time by arriving fully assembled.

Simple To Setup

Filter/Regulator & Lubrication allows for simple setup and decreases maintenance by extending the life of the pneumatic counterbalance.

Automatic Tool Lubrication

Lubrication Where It's Needed

Through the cage Auto-Lubrication increases tool life by providing lubrication directly to the working end of the tool.

Automatically Dispenses

Reduces time wasted applying and cleaning up excess lubrication by providing a consistent amount of lubricant with each expansion.

More Consistent Expansions

Pressurized lubrication tank increases expansion consistency by providing a consistent flow of lubricant for a wide variety of lubricant viscosities.



Built-in Safety Features



Supports Tool Weight

“ At Trane, we have an unceasing pursuit for improving our manufacturing processes. Having manufacturing partners that are equally engaged is essential to a sustainable future. Elliott Tool Technologies has embraced that role with **swift response by leading and providing custom tool solutions to match our continuous improvement goals.**

Max Ford, Manufacturing Engineer

Trane Technologies, LaCrosse WI



TABLE HAWK™

Tabletop Assisted Tube Rolling System

Tube Size

- 0.250" to 0.625" OD
- (6.35 to 15.9mm) OD



SMALL TUBES, HIGH PRECISION.

Engineered to productively and precisely expand small tubes commonly found in oil coolers and other small heat exchangers. Elliott's tabletop assisted tube rolling system completes the job right the first time.

Elliott's Table Hawk is the first tabletop system to offer the speed and productivity of a pneumatic motor with the precision and control of an electronic system. It maximizes productivity by providing best in class cycle times and eliminating costly rework from less precise methods.

Combining Elliott's patent pending Direct Torque™ technology with a pneumatically driven power head, operators simply set a torque and start rolling. The system monitors torque and provides consistently precise wall reductions for every expansion.

Ergonomically and productively roll smaller vessels easily. The Table Hawk's articulated arm supports the weight and absorbs the torque of the rolling motor using a pneumatic counterbalance, which allows the operator to effortlessly move the motor into position. The Table Hawk can be mounted to a table or wheeled cart.





Operator Friendly Controls



Auto-Cycle & Triggerless Operation

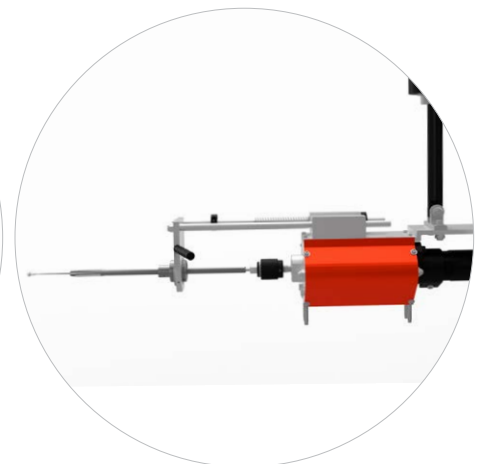

Power Head & Expander Holder

Increased Productivity & Ergonomics

Start, Stop, & Reverse Automatically
Auto-Cycling increases speed and precision with a Power Head that runs automatically –starting, stopping, and reversing without operator intervention.

Faster Motor, Same Precise Control
Increase speed with a pneumatic motor and roll each tube to spec with the electronic control system.

Trigger-less Operation
Increases ergonomics with a simple on/off switch for operation. No need to hold down a trigger during the entire job.

Articulated Arm
Increases operator ergonomics and decreases operator fatigue by supporting tool weight and absorbing torque.

Counterbalance
Decreases operator fatigue by allowing effortless and exact positioning of the articulated arm and rolling motor.

Change Tooling Quickly
Quickly change out Elliott's long-lasting 24 Series Condenser Expanders with the built-in quick change chuck system.

Quick & Easy Setup

Fully Assembled Articulated Arm
Minimizes setup time by arriving fully assembled. Simply mount the arm to a tabletop or cart and connect the airlines.

Operator Friendly Controls
User simply sets torque with the easy-to-use control panel.

Filter/Regulator and Lubrication
Allows for simple setup of the Table Hawk and decreases maintenance by extending the life of the air motor.

Consistent Tube Expansion

Roll Every Tube To Spec
Direct Torque™ Electric Torque Control measures torque and controls system functions regardless of fluctuations in air supply. Allows you to roll to the target wall reduction each time to eliminate costly re-rolling.

Increase Tool Life
Swivel Mount securely supports the Power Head to ensure expander alignment and increase expander life.

Maintain Tool Alignment
Expander holder increases tool life and ensures consistently rolled tubes with an expander holder that guides the expander and maintains tool alignment.



TABLE HAWK™

Tabletop Assisted Tube Rolling System

TABLE HAWK

| Packages | | | |
|---------------|----------|----------|------------|
| Tube OD Range | Package | Motor | Power Head |
| 1/4" - 5/8" | TTRS1900 | TTRM1900 | TTR100 |

Each package includes the Articulated Arm, Motor, Pneumatic Power Head, and Swivel Mount System.

| Articulated Arm Specifications | | Articulated Arm Specifications | |
|------------------------------------|---------------------|--------------------------------|--|
| Specifications | | Dimensions & Weight | |
| Maximum Torque Absorption | 100 ft. lbs | Working Area/Footprint | 32" (813 mm) maximum height |
| Maximum Weight Supported | 35 lbs (15.88 Kg) | | 22" (559 mm) minimum height |
| Standard Tool Mount Diameter Range | 1-2" (25.4-50.8 mm) | | 35" (889 mm) maximum width |
| Horizontal Radius Reach | 33" (838 mm) | | 26.5" (671 mm) minimum width |
| Vertical Range (without tool) | 20" (508 mm) | | 5.4" (137 mm) depth (mounting base diameter) |
| Arm Rotation | 360° | Unit Weight | 70 lbs. (31.75 Kg) |

| Power Head Specifications | | | | | | | | | |
|---------------------------|------------------------|------------------|--------------------------|---------------------|------------|------------|-------------------|------------------------|-----------------------------|
| Motor Part Number | Power Head Part Number | Air Consumption | Free Speed RPM (No Load) | Torque At Max Power | Min Torque | Max Torque | Power Head Weight | Transducer Part Number | Included Square Quick Chuck |
| TTRM1900 | TTR100 | 29.7 cfm @ 90PSI | 1900 | 42 in-lbs | 5 in-lbs | 42 in-lbs | 8.7 lbs. (3.9kg) | TTR121 | 1/4" |



WHY CHOOSE ELLIOTT?

HEAR FROM OUR CUSTOMERS

“ The team at Elliott Tool not only sold me exactly what I needed, they took the time to come to my office and train my team on the proper way to use the tools and proper maintenance of the tools... A wise man once told me to surround yourself with successful people and you will be successful. **Elliott Tool will always be part of my team!**

James Williams, Owner
Williams Mechanical Services

“ At Trane, we have an unceasing pursuit for improving our manufacturing processes. Having manufacturing partners that are **equally engaged is essential to a sustainable future.** Elliott Tool Technologies has embraced that role with swift response by leading and providing custom tool solutions to match our continuous improvement goals.

Max Ford, Manufacturing Engineer
Williams Mechanical Services

“ **Support was the reason** we went with the Elliott equipment. The product is great and the people we worked with have been great.

-Ryan Pitre,
Manufacturing Engineer
Alfa Laval Inc

“ Elliott's service has always been **good and reliable** and replacement parts and consumables are available if we need them.

Charles Gardinier, Chilling Station Maintenance Supervisor
University of Texas at Austin

RAPID HAWK™

Assisted Tube Rolling System

Tube Size

- 0.625" to 1.500" OD
- (15.9 to 38.1mm) OD

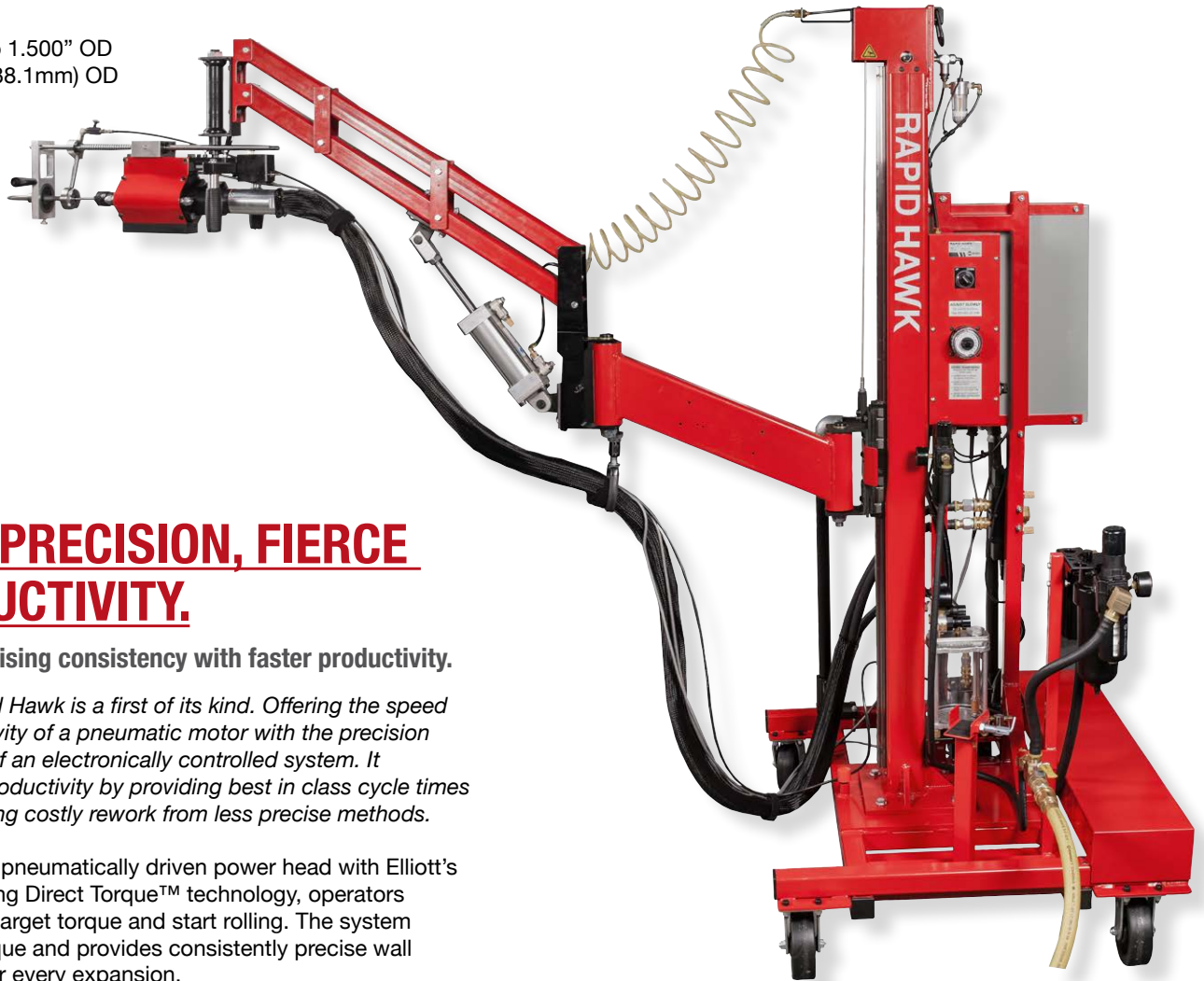

BOLD PRECISION, FIERCE PRODUCTIVITY.

Uncompromising consistency with faster productivity.

Elliott's Rapid Hawk is a first of its kind. Offering the speed and productivity of a pneumatic motor with the precision and control of an electronically controlled system. It maximizes productivity by providing best in class cycle times and eliminating costly rework from less precise methods.

Combining a pneumatically driven power head with Elliott's patent pending Direct Torque™ technology, operators simply set a target torque and start rolling. The system monitors torque and provides consistently precise wall reductions for every expansion.

The Hybrid Series takes ergonomics and productivity to a new level with trigger-less operation and auto-cycling. Simply turn the system on and it will start, stop and reverse without any operator intervention.

“ We have over 280,000 expansions on the Rapid Hawk, with the capability of **360 expansions per hour**, with 0 tube joint leaks due to the system, and with 0 downtime.

Mark Chisum, Manufacturing Engineer
Metalforms, Ltd.



| Rapid Hawk Packages | | |
|---------------------|---------|------------|
| Rapid Hawk Package | Motor | Spares Kit |
| PTRS830L | PTRM830 | PTR180SK |
| PTRS500L | PTRM500 | |
| PTRS370L | PTRM370 | |

Each Rapid Hawk Package includes the Rapid Hawk, Electronic Torque Control, Auto Cycle, Expander Holder, Through The Cage Auto-Lubrication, Rotary Lube Adapter, Expander Adapter, Pneumatic Power Head and Swivel Mount System.

Spares Kit includes:

- Air motor spares kit
- Cable cylinder spares kit
- Tie rod cylinder seal set
- 40 micron filter (air filter/regulator)
- Lubricator service kit (air motor lubricator)
- 5 micron filter (air motor filter/regulator)

Increased Productivity

Start, Stop, & Reverse Automatically

Auto-Cycling increases speed and precision with a Power Head that runs automatically –starting, stopping, and reversing without operator intervention.

Faster Motor, Same Precise Control

Increase speed with a pneumatic motor and roll each tube to spec with the electronic control system.

Zero Trigger Cycling

Trigger-less operation increases ergonomics with a simple on/off switch for operation. No need to hold down a trigger during the entire job.

Automatic Tool Lubrication

Through the cage Auto-Lubrication increases tool life by providing automatic expander lubrication exactly where it's needed, through the cage and directly to the rolls & mandrels. No messy cleanup by providing the right amount of lube with each expansion. See page 72 for more information.

Change Tooling Quickly

Quickly change out Elliott's long-lasting 24 Series Condenser Expanders with the built-in quick change chuck system.

Operator Friendly

Operator Friendly Controls

User simply sets torque with the easy to use control panel.

Modular Motor System

Purchase additional motors to quickly change between various torque and OD ranges due to the system's modular design.

Easy To Move

Heavy-duty casters, forklift pockets, and hoist ring, provide a variety of methods to easily move the system around facilities.

Consistent Tube Expansion

Roll Every Tube To Spec

Direct Torque™ Electric Torque Control measures torque and controls system functions regardless of fluctuations in air supply. Allows you to roll to the target wall reduction each time to eliminate costly re-rolling.

Increase Tool Life

Swivel Mount securely supports the Power Head to ensure expander alignment and increase expander life.

Maintain Tool Alignment

Expander holder increases tool life and ensures consistently rolled tubes with an expander holder that guides the expander and maintains tool alignment.



Operator Friendly Controls

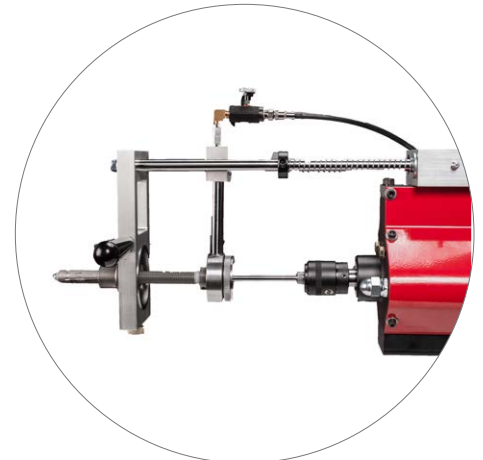

Roll Every Tube To Spec

Power Head Specifications

| Motor w/ Hoses | Air Consumption | Free Speed RPM (No Load) | Torque At Max Speed & Power | Min Torque | Max Motor Stall Torque | Power Head Weight | Transducer* | Recommended Square Chuck* |
|----------------|-----------------|--------------------------|-----------------------------|------------|------------------------|-------------------|-------------|---------------------------|
| PTRM830H | 66 cfm @ 90 psi | 830 | 21 ft-lbs | 3.5 ft-lbs | 35 ft-lbs | 21 lbs (9.5kg) | PX121 | 3/8 |
| PTRM500H | | 500 | 35 ft-lbs | 3.5 ft-lbs | 55 ft-lbs | | | 3/8 & 1/2 |
| PTRM370H | | 370 | 47 ft-lbs | 3.5 ft-lbs | 80 ft-lbs | | | |

*Included with Rapid Hawk package



RAPID HAWK™

Assisted Tube Rolling System

The Rapid Hawk's through the cage Auto-Lubrication system provides lubricant where it's needed most, to the rolls and mandrel. Most lubrication systems only provide lubricant through the collar, which is often positioned too far from the working end of the tool, especially when working with thicker tube sheets or header boxes. By providing the lubricant through a sealed cage, Elliott's revolutionary new design increases tool life and reduces time wasted applying and cleaning up excess lubricant.

The Auto-Lubrication system is designed to work seamlessly with the Hybrid Series Rapid Hawk. Working in conjunction with the Auto-Cycle feature, the system will apply a consistent amount of lubricant during each expansion cycle. The amount of lubricant used for each expansion is easily adjustable and the system is capable of handling a variety of lubricant viscosities.

In order to allow for proper sealing of the cage for lubrication flow, a specially designed 24 Series expander is needed. However, when necessary, the Auto-Lubrication system can be turned off and any expander can be used with the Rapid Hawk.

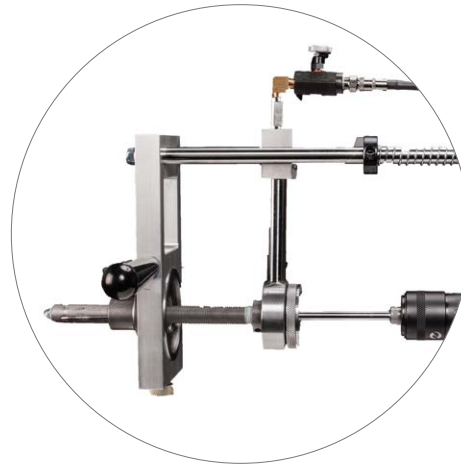

Auto-Lubrication System
With Expander Holder



Auto-Lubrication Tank

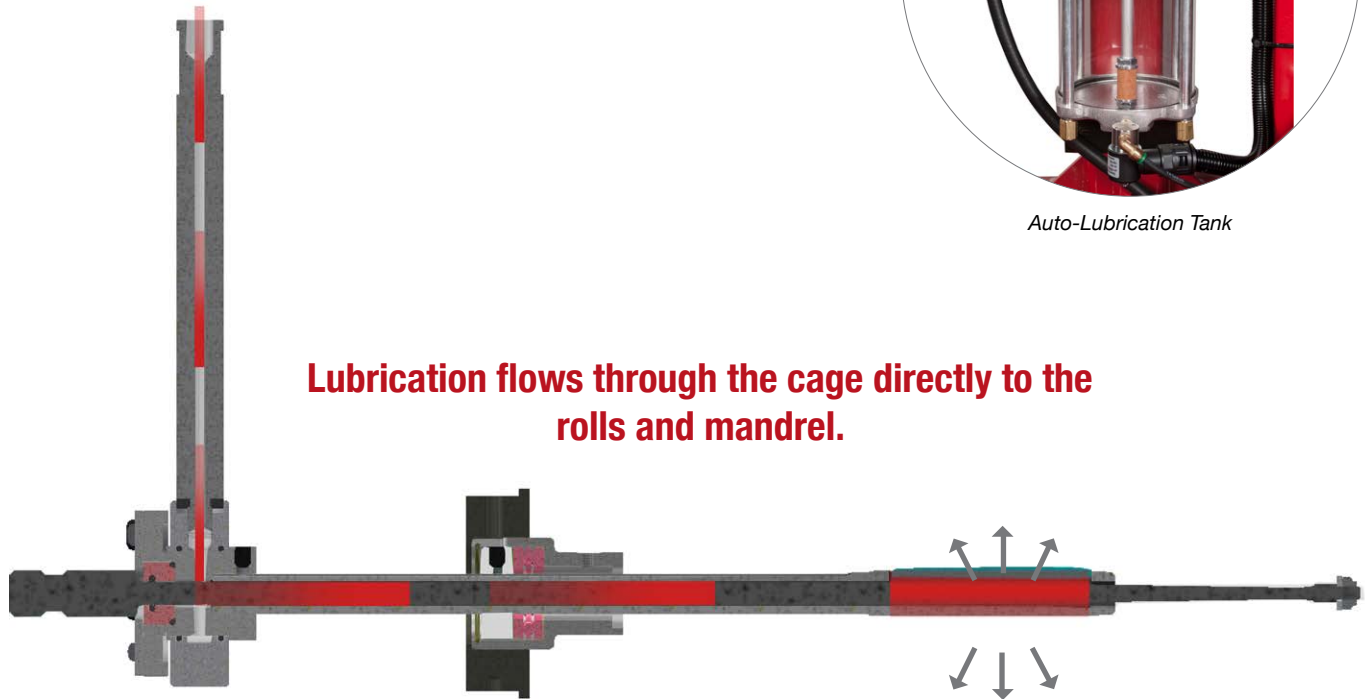

RAPID HAWK

Spares & Accessories

- P8395 & P8784 Tube Rolling Lubricant: See page 19 for part numbers.
- Rotary Lube Adapter: Connects the expander cage to the lubrication system.
- Cage Adapter: Connects the expander cage to the rotary lube adapter. One included with the rotary lube adapter.
- Lube Spacer w/ O-ring: One included with each expander. Seals the mandrel and back of cage adapter.
- Expander Adapter: Holds the expander in the expander holder.
- Rapid Hawk Service Plan: Keep your Rapid Hawk in top operating condition, ensuring uptime and productivity.

| Rapid Hawk Specifications | |
|---|-----------------------------------|
| Power | |
| Pneumatic Requirements | 1.5 CFM, 100 PSI |
| Power Requirements* | 115/230 V IPH 50/60Hz |
| Specifications | |
| Horizontal Radius Reach | 5.5' (1.68 m) |
| Vertical Reach | 2' - 8' (610mm - 2.44m) |
| Dimensions & Weight | |
| Working Area/Footprint | 79" - 119" (2.01 - 3.02 m) height |
| | 43" (1.09 m) width |
| | 34" - 95" (864 mm - 2.41m) depth |
| Unit Weight | 883 lbs. (400.5 Kg) |
| Shipping Dimensions (crated) | 90" (2.29 m) height |
| | 66" (1.68 m) width |
| | 63" (1.60 m) depth |
| Shipping Weight (crated) | 1,318 lbs. (597.8 Kg) |
| * May require removal of supplied plug & installation of plug suitable based on locality requirement. | |

*63L, 64L and 65L will need Expander Holder PTR190X1



| Spares & Accessories | | | | |
|----------------------|---------------------|---------------------|------------------|----------------|
| Expander | Rotary Lube Adapter | Lube Spacer 10-Pack | Expander Adapter | |
| *21L* | 24RLA250 | 24LS21-10 | ETA100A-1-1-4 | |
| *22L* | 24RLA313 | 24LS22-10 | | |
| *23L* | 24RLA343 | 24LS23-10 | | |
| *24L* | 24RLA375 | 24LS24-10 | | |
| *25L* | | 24LS25-10 | | |
| *26L* | | 24LS26-10 | | |
| *27L* | 24RLA437 | 24LS27-10 | ETA100A-1-5-16 | |
| *28L* | | 24LS28-10 | | |
| *29L* | | 24LS29-10 | | |
| *30L* | | 24LS30-10 | | |
| *31L* | 24RLA500 | 24LS31-10 | ETA100A-1-7-16 | |
| *32L* | | 24LS32-10 | | |
| *33L* | | 24RLA562 | | 24LS34-10 |
| *34L* | 24LS35-10 | | | |
| *35L* | 24RLA625 | | 24LS36-10 | ETA100A-1-5-8 |
| *36L* | | | 24LS40-10 | |
| *38L* | | 24RLA750 | 24LS42-10 | |
| *39L* | 24LS45-10 | | | |
| *40L* | 24LS46-10 | | | |
| *41L* | 24RLA875 | | 24LS49-10 | ETA100A-2-1-16 |
| *42L* | | 24LS51-10 | | |
| *43L* | | 24LS53-10 | | |
| *44L* | 24RLA1000 | 24LS55-10 | ETA100A-2-1-4 | |
| *45L* | | 24LS56-10 | | |
| *46L* | | 24LS58-10 | | |
| *47L* | | 24LS59-10 | | |
| *49L* | 24RLA1000 | 24LS60-10 | ETA100A-2-5-8 | |
| *50L* | | 24LS63-10 | | |
| *51L* | | 24RLA1000 | | 24LS63-10 |
| *52L* | 24LS63-10 | | | |
| *53L* | 24RLA1000 | 24LS63-10 | | |
| *54L* | | 24LS63-10 | | |
| *55L* | 24RLA1000 | 24LS63-10 | | |
| *56L* | | 24LS63-10 | | |
| *57L* | 24RLA1000 | 24LS63-10 | | |
| *58L* | | 24LS63-10 | | |
| *59L* | 24RLA1000 | 24LS63-10 | | |
| *60L* | | 24LS63-10 | | |
| *61L* | 24RLA1000 | 24LS63-10 | | |
| *62L* | | 24LS63-10 | | |
| *63L* | 24RLA1000 | 24LS63-10 | | |
| *64L* | | 24LS63-10 | | |
| *65L* | 24RLA1000 | 24LS63-10 | | |
| *66L* | | 24LS63-10 | | |

*Expander size (i.e. 24229L or 24129L-8= *29L*)
Rotary Lube Adapter includes the cage adapter.

3 Roll Auto-Lubrication Condenser Expanders

Tube Size

- 0.500" to 1.500" OD
- (12.7 to 38.1mm) OD



**For additional reaches, add "-XX" to the end of the part number for desired length.
(ie. 24131L-12 signifies a 12" reach tool)**

| 3 Roll Expanders | | | | | | | | | | | | | | |
|-------------------|----------------|-----------------|-----------|-------|-------|--------|------|--|-------------|-------------|---|-------------|-------------|----------------|
| Tube Size | | Expansion Range | | | | | | Tube Sheet (Min/Max Reach) 0.500" - 3.830" (12.7-97.3mm) | | | Tube Sheet (Min/Max Reach) 1.250" - 4.200" (31.8-106.7mm) | | | Common Mandrel |
| | | | | | | | | Overall Roll Length 1-5/8" (41.3mm) | | | Overall Roll Length 2-3/8" (60.3mm) | | | |
| OD | Wall Thickness | | | Inch | | Metric | | Expander Assembly | | Roll Set | Expander Assembly | | Roll Set | |
| | BWG | In | Metric | Min. | Max. | Min. | Max. | Flush | 1/8" Recess | (3 per set) | Flush | 1/8" Recess | (3 per set) | |
| 1/2" (12.7mm) | 13 | 0.095 | 2.41 | 0.305 | 0.340 | 7.7 | 8.6 | 24121L | 24121RB8L | 241R21-3** | 24221L | 24221RB8L | 242R21-3*** | 24ML21 |
| | 14 | 0.083 | 2.11 | 0.324 | 0.366 | 8.4 | 9.3 | 24122L | 24122RB8L | | 24222L | 24222RB8L | | 24ML22 |
| | 15 | 0.072 | 1.83 | 0.346 | 0.386 | 8.8 | 9.7 | 24123L | 24123RA8L | 241R22-3** | 24223L | 24223RA8L | 242R22-3*** | 24ML23 |
| | 16-17 | 0.065-0.085 | 1.65-1.47 | 0.367 | 0.410 | 9.1 | 10.4 | 24124L | 24124RA8L | 241R24-3** | 24224L | 24224RA8L | 242R24-3*** | 24ML24 |
| | 18 | 0.049 | 1.24 | 0.392 | 0.447 | 10.0 | 11.3 | 24125L | 24125RA8L | 241R25-3** | 24225L | 24225RA8L | 242R25-3*** | 24ML25 |
| | 19-20 | 0.042-0.035 | 1.07-0.89 | 0.402 | 0.457 | 10.2 | 11.6 | 24126L | 24126RA8L | 241R26-3** | 24226L | 24226RA8L | 242R26-3*** | |
| | 21-22 | 0.035-0.028 | 0.81-0.71 | 0.425 | 0.482 | 10.8 | 12.3 | 24127L | 24127RA8L | 241R27-3** | 24227L | 24227RB8L | 242R27-3*** | 24ML27 |
| 5/8" (15.9mm) | 12 | 0.109 | 2.77 | 0.392 | 0.447 | 10.0 | 11.3 | 24125L | 24125RB8L | 241R25-3** | 24225L | 24225RB8L | 242R25-3*** | 24ML25 |
| | 13 | 0.095 | 2.41 | 0.425 | 0.482 | 10.8 | 12.3 | 24127L | 24127RB8L | 241R27-3** | 24227L | 24227RB8L | 242R27-3*** | 24ML27 |
| | 14 | 0.083 | 2.11 | 0.449 | 0.506 | 11.4 | 12.8 | 24128L | 24128RA8L | 241R28-3 | 24228L | 24228RA8L | 242R28-3 | 24ML28 |
| | 15 | 0.072 | 1.83 | 0.471 | 0.524 | 12.0 | 13.3 | 24129L | 24129RA8L | | 24229L | 24229RA8L | | 24ML29 |
| | 16 | 0.065 | 1.65 | 0.485 | 0.538 | 12.3 | 13.7 | 24129BL | 24129BRA8L | 241R29-3 | 24229BL | 24229BRA8L | 242R29-3 | |
| | 17 | 0.058 | 1.47 | 0.499 | 0.564 | 12.7 | 14.3 | 24130L | 24130RA8L | 241R30-3 | 24230L | 24230RA8L | 242R30-3 | 24ML30 |
| | 18-19 | 0.049-0.042 | 1.24-1.07 | 0.517 | 0.584 | 13.1 | 14.8 | 24131L | 24131RA8L | 241R31-3 | 24231L | 24231RA8L | 242R31-3 | 24ML31 |
| | 20-22 | 0.035-0.028 | 0.89-0.71 | 0.540 | 0.609 | 13.7 | 15.5 | 24132L | 24132RA8L | 241R32-3 | 24232L | 24232RA8L | 242R32-3 | 24ML32 |
| 3/4" (19.14mm) | 10 | 0.134 | 3.40 | 0.471 | 0.538 | 12.0 | 13.7 | 24129L | 24129RB8L | 241R29-3 | 24229L | 24229RB8L | 242R29-3 | 24ML29 |
| | 11 | 0.120 | 3.05 | 0.499 | 0.564 | 12.7 | 14.3 | 24130L | 24130RB8L | 241R30-3 | 24230L | 24230RB8L | 242R30-3 | 24ML30 |
| | 12 | 0.109 | 2.77 | 0.517 | 0.584 | 13.1 | 14.8 | 24131L | 24131RB8L | 241R31-3 | 24231L | 24231RB8L | 242R31-3 | 24ML31 |
| | 13 | 0.095 | 2.41 | 0.540 | 0.609 | 13.7 | 15.5 | 24132L | 24132RB8L | 241R32-3 | 24232L | 24232RB8L | 242R32-3 | 24ML32 |
| | 14 | 0.083 | 2.11 | 0.562 | 0.631 | 14.3 | 16.0 | 24133L | 24133RA8L | 241R33-3 | 24233L | 24233RA8L | 242R33-3 | |
| | 15-16 | 0.072-0.065 | 1.83-1.65 | 0.592 | 0.672 | 15.0 | 17.1 | 24134L | 24134RA8L | 241R34-3 | 24234L | 24234RA8L | 242R34-3 | 24ML34 |
| | 17-18 | 0.058-0.049 | 1.47-1.24 | 0.620 | 0.697 | 15.7 | 17.7 | 24135L | 24135RA8L | 241R35-3 | 24235L | 24235RA8L | 242R35-3 | 24ML35 |
| | 19-22 | 0.042-0.028 | 1.07-0.71 | 0.641 | 0.731 | 16.3 | 18.6 | 24136L | 24136RA8L | 241R36-3 | 24236L | 24236RA8L | 242R36-3 | 24ML36 |
| 7/8" (22.2mm) | 10 | 0.134 | 3.40 | 0.592 | 0.672 | 15.0 | 17.1 | 24134L | 24134RB8L | 241R34-3 | 24234L | 24234RB8L | 242R34-3 | 24ML34 |
| | 11 | 0.120 | 3.05 | 0.620 | 0.697 | 15.7 | 17.7 | 24135L | 24135RB8L | 241R35-3 | 24235L | 24235RB8L | 242R35-3 | 24ML35 |
| | 12 | 0.109 | 2.77 | 0.641 | 0.731 | 16.3 | 18.6 | 24136L | 24136RB8L | 241R36-3 | 24236L | 24236RB8L | 242R36-3 | 24ML36 |
| | 13 | 0.095 | 2.41 | 0.655 | 0.745 | 16.6 | 18.9 | 24138L | 24138RA8L | 241R38-3 | 24238L | 24238RA8L | 242R38-3 | |
| | 14 | 0.083 | 2.11 | 0.675 | 0.765 | 17.1 | 19.4 | 24139L | 24139RA8L | | 24239L | 24239RA8L | | 24ML40 |
| | 15-16 | 0.072-0.065 | 1.83-1.65 | 0.715 | 0.800 | 18.2 | 20.3 | 24140L | 24140RA8L | 241R39-3 | 24240L | 24240RA8L | 242R39-3 | |
| | 17-19 | 0.058-0.049 | 1.47-1.07 | 0.743 | 0.828 | 18.9 | 21.0 | 24141L | 24141RA8L | 241R41-3 | 24241L | 24241RA8L | 242R41-3 | 24ML40 |
| | 20-22 | 0.035-0.028 | 0.89-0.71 | 0.795 | 0.865 | 20.2 | 22.0 | 24142L | 24142RA8L | 241R42-3 | 24242L | 24242RA8L | 242R42-3 | 24ML42 |



RAPID HAWK

3 Roll Auto-Lubrication Condenser Expanders

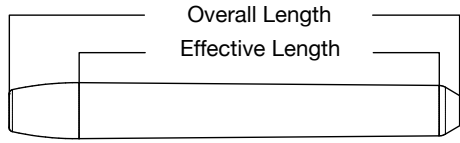

| Roll Part Number | Overall Roll Length | Effective Roll Length |
|------------------|---------------------|-----------------------|
| 241R21 - 241R27 | 1.500" (38.1mm) | 1.187" (30.1mm) |
| 241R28 - 241R42 | 1.625" (41.3mm) | 1.301" (33.0mm) |
| 241R43 - 241R65 | | 1.239" (31.5mm) |
| 242R21 - 242R27 | 2.250" (57.2mm) | 1.937" (49.2mm) |
| 242R28 - 242R42 | 2.365" (60.3mm) | 2.051" (52.1mm) |
| 242R43 - 242R65 | | 1.989" (50.5mm) |

| 3 Roll Expanders | | | | | | | | | | | | | | |
|------------------|----------------|-------------|-----------------|-------|--------|------|--|-----------|-------------|---|-----------|-------------|----------------|-----------|
| Tube Size | | | Expansion Range | | | | Tube Sheet (Min/Max Reach) 0.500" - 3.830" (12.7-97.3mm) Overall Roll Length 1-5/8" (41.3mm) **Overall Roll Length 1-1/2" (38.1mm) | | | Tube Sheet (Min/Max Reach) 1.250" - 4.200" (31.8-106.7mm) Overall Roll Length 2-3/8" (60.3mm) ***Overall Roll Length 2-1/4" (57.15mm) | | | Common Mandrel | |
| OD | Wall Thickness | | Inch | | Metric | | Expander Assembly | | Roll Set | Expander Assembly | | Roll Set | | |
| | BWG | In | Metric | Min. | Max. | Min. | Max. | Flush | 1/8" Recess | (3 per set) | Flush | 1/8" Recess | (3 per set) | |
| 1" (25.4mm) | 8 | 0.165 | 4.19 | 0.655 | 0.745 | 16.6 | 18.9 | 24138L | 24138RB8L | 241R38-3 | 24238L | 24238RB8L | 242R38-3 | 24ML36 |
| | 9 | 0.148 | 3.76 | 0.675 | 0.765 | 17.1 | 19.4 | 24139L | 24139RB8L | 241R39-3 | 24239L | 24239RB8L | 242R39-3 | |
| | 10 | 0.134 | 3.40 | 0.715 | 0.800 | 18.2 | 20.3 | 24140L | 24140RB8L | | 241R41-3 | 24240L | | 24240RB8L |
| | 11 | 0.120 | 3.05 | 0.743 | 0.828 | 18.9 | 21.0 | 24141L | 24141RB8L | 241R42-3 | | 24241L | 24241RB8L | 242R42-3 |
| | 12-13 | 0.109-0.095 | 2.77-2.41 | 0.769 | 0.866 | 19.5 | 22.0 | 24143L | 24143RA8L | | 241R44-3 | 24243L | 24243RA8L | |
| | 14 | 0.083 | 2.11 | 0.799 | 0.896 | 20.3 | 22.7 | 24144L | 24144RA8L | 241R46-3 | | 24244L | 24244RA8L | 242R46-3 |
| | 15-16 | 0.072-0.065 | 1.83-1.65 | 0.841 | 0.922 | 21.4 | 23.4 | 24145L | 24145RA8L | | 241R47-3 | 24245L | 24245RA8L | |
| | 17-19 | 0.058-0.042 | 1.47-1.07 | 0.872 | 0.968 | 22.1 | 24.6 | 24146L | 24146RA8L | 241R47-3 | | 24247L | 24247RA8L | 242R47-3 |
| 20-22 | 0.035-0.028 | 0.89-0.71 | 0.894 | 0.990 | 22.7 | 25.2 | 24147L | 24147RA8L | 241R42-3 | 24243L | 24243RB8L | 242R42-3 | | |
| 1-1/8" (28.6mm) | 8 | 0.165 | 4.19 | 0.769 | 0.866 | 19.5 | 22.0 | 24143L | 24143RB8L | 241R44-3 | 24244L | 24244RB8L | 242R44-3 | 24ML43 |
| | 9 | 0.148 | 3.76 | 0.799 | 0.896 | 20.3 | 22.7 | 24144L | 24144RB8L | | 241R46-3 | 24244L | | |
| | 10 | 0.134 | 3.40 | 0.841 | 0.922 | 21.4 | 23.4 | 24145L | 24145RB8L | 241R47-3 | | 24245L | 24245RB8L | 242R47-3 |
| | 11-12 | 0.120-0.109 | 3.05-2.77 | 0.872 | 0.968 | 22.1 | 24.6 | 24146L | 24146RB8L | | 241R50-3 | 24246L | 24246RB8L | |
| | 13 | 0.095 | 2.41 | 0.894 | 1.009 | 22.7 | 25.6 | 24149L | 24149RA8L | 241R55-3 | | 24249L | 24249RA8L | 242R55-3 |
| | 14-15 | 0.083-0.072 | 2.11-1.83 | 0.924 | 1.039 | 23.5 | 26.4 | 24150L | 24150RA8L | | 241R57-3 | 24250L | 24250RA8L | |
| | 16-18 | 0.065-0.049 | 1.65-1.24 | 0.978 | 1.078 | 24.8 | 27.4 | 24151L | 24151RA8L | 241R52-3 | | 24251L | 24251RA8L | 242R52-3 |
| 19-22 | 0.042-0.028 | 1.07-0.71 | 1.016 | 1.116 | 25.8 | 28.4 | 24152L | 24152RA8L | 241R52-3 | 24252L | 24252RA8L | 242R52-3 | | |
| 1-1/4" (31.8mm) | 8 | 0.165 | 4.19 | 0.894 | 1.009 | 22.7 | 25.6 | 24149L | 24149RB8L | 241R47-3 | 24249L | 24249RB8L | 242R47-3 | 24ML49 |
| | 9 | 0.148 | 3.76 | 0.924 | 1.039 | 23.5 | 26.4 | 24150L | 24150RB8L | | 241R53-3 | 24250L | | |
| | 10-11 | 0.134-0.120 | 3.40-3.05 | 0.962 | 1.083 | 24.4 | 27.5 | 24153L | 24153RA8L | 241R55-3 | | 24253L | 24253RA8L | 242R55-3 |
| | 12-13 | 0.109-0.095 | 2.77-2.41 | 1.012 | 1.128 | 25.7 | 28.7 | 24155L | 24155RA8L | | 241R56-3 | 24255L | 24255RA8L | |
| | 14-17 | 0.083-0.058 | 2.11-1.47 | 1.066 | 1.195 | 27.1 | 30.3 | 24156L | 24156RA8L | 241R57-3 | | 24257L | 24257RA8L | 242R57-3 |
| 1-3/8" (34.9mm) | 8 | 0.165 | 4.19 | 1.012 | 1.128 | 25.7 | 28.7 | 24155L | 24155RB8L | 241R52-3 | 24255L | 24255RB8L | 242R52-3 | 24ML55 |
| | 9-10 | 0.148-0.134 | 3.76-3.40 | 1.066 | 1.195 | 27.1 | 30.3 | 24156L | 24156RB8L | | 241R58-3 | 24256L | | |
| | 11 | 0.120 | 3.05 | 1.115 | 1.218 | 28.3 | 30.9 | 24158L | 24158RA8L | 241R57-3 | | 24258L | 24258RA8L | 242R57-3 |
| | 12-13 | 0.109-0.095 | 2.77-2.41 | 1.127 | 1.263 | 28.6 | 32.1 | 24159L | 24159RA8L | | 241R60-3 | 24259L | 24259RA8L | |
| | 14-17 | 0.083-0.058 | 2.11-1.47 | 1.180 | 1.322 | 30.0 | 33.6 | 24160L | 24160RA8L | 241R61-3 | | 24260L | 24260RA8L | 242R61-3 |
| | 18-22 | 0.049-0.028 | 1.24-0.71 | 1.224 | 1.365 | 31.1 | 34.7 | 24161L | 24161RA8L | | 241R61-3 | 24261L | 24261RA8L | |
| 1-1/2" (38.1mm) | 8 | 0.165 | 4.19 | 1.127 | 1.263 | 28.6 | 32.1 | 24159L | 24159RB8L | 241R57-3 | 24259L | 24259RB8L | 242R57-3 | 24ML59 |
| | 9-10 | 0.148-0.134 | 3.76-3.40 | 1.180 | 1.322 | 30.0 | 33.6 | 24160L | 24160RB8L | | 241R61-3 | 24260L | | |
| | 11-12 | 0.120-0.109 | 3.05-2.77 | 1.224 | 1.365 | 31.1 | 34.7 | 24161L | 24161RB8L | 241R64-3 | | 24261L | 24261RB8L | 242R64-3 |
| | 13-14 | 0.095-0.083 | 2.41-2.11 | 1.285 | 1.415 | 32.6 | 35.9 | 24163L | 24163RA8L | | 241R65-3 | 24263L | 24263RA8L | |
| | 15-17 | 0.072-0.058 | 1.83-1.47 | 1.325 | 1.455 | 33.7 | 36.9 | 24164L | 24164RA8L | 241R65-3 | | 24264L | 24264RA8L | 242R65-3 |
| | 18-22 | 0.049-0.028 | 1.24-0.71 | 1.361 | 1.490 | 34.6 | 37.9 | 24165L | 24165RA8L | | 241R65-3 | 24265L | 24265RA8L | |



REDUCES EXPANSION CYCLE TIMES BY 80%



QUICK SUMMARY

The Challenge

- Current rolling motors were not providing a consistent and repeatable approach to tube expansion
- Overheating required frequent tool changes, resulting in downtime
- Manual tool lubrication for large jobs can extend job duration
- Heavy handheld motors cause downtime due to operator fatigue and pose safety concerns

The Solution

- Ultra Hawk's speed and productivity of an electric servo motor plus its parallel pin and traditional expansion capabilities
- Production trials to determine joint consistency, cycle times, and operator ergonomic improvements.

The Results

- Cycle time savings of 80% per tube, from 22 seconds to 4 seconds
- Through-the-cage auto-lubrication increased tool life 3:1 compared to using an 850 Rolling Motor
- Zero tube leaks due to the system, reducing the number of man-hours attributed to re-rolling
- Increased ergonomics provide a safer rolling method and reduced operator fatigue

The Challenge

Dunn Heat Exchangers, Inc., a fabrication company located in Texas City, Texas, offers heat exchanger cleaning, decontamination, repair, and fabrication services in the highly competitive shell and tube market. Offering services 24 hours a day, seven days a week, means that productivity and efficiency are key to offering the fastest turnaround time to customers.

One of the main challenges facing the team was the amount of time it took to complete a job. Using an 850-style push-pull motor with a traditional expander, it was easy to add days onto a job due to lower tool life, operator fatigue, and downtime.

Downtime and longer expansion cycle times were largely due to frequent tooling change outs. Relying on a manual tool lubrication process, the operator would need to lubricate each tube prior to starting a job. However, this process was often not enough to prevent early wear and overheating of tools, resulting in extra downtime to change tooling.

Operator fatigue and safety was also a concern for the Dunn team. Holding a handheld motor requires the operator to support about 14 lbs. or more, while absorbing about 12 ft lbs. of torque during each tube expansion. "When doing tapered pin expansion, if the tool slipped from your hands after catching the ID of the tube, I have little doubt it could break someone's arm," said Pete Dunn Jr, President. Over a few thousand expansions, fatigue can take over causing a slow down in productivity and increase safety concerns for operators.

With a desire to increase cycle times, acquire more jobs, and improve operator safety, the team at Dunn Heat Exchanger decided to collaborate with Elliott Tool Technologies to find a better solution.

The Solution

Elliott's new, truly complete rolling system, the Ultra Hawk, offers the speed and productivity of an electric servo motor with the capability to perform parallel pin and traditional expansion. Productivity is maximized through best-in-class cycle times and the need for rework is lowered by providing consistent, reliable expansion.

With the Ultra Hawk's parallel pin feature, you can see up to 2Xs the speed on cycle times. Parallel pin rolling also helps to reduce the force exerted against the tube and tube sheet, eliminating costly tube sheet damage and warping.

This system ensures every tube is rolled to spec through a measurement of torque and controls system functions which allows tubes to be rolled to the target wall reduction each time to eliminate costly re-rolling. Data output ensures customers that quality control metrics and customer requirements are met, and that the vessel will pass hydro.

After trialing the Ultra Hawk assisted rolling system, Dunn Heat Exchanger decided that the productivity and consistency of the system were exactly what they were looking for. Additionally, the ergonomics and easy set-up made the Ultra Hawk their desired method for tube expansion moving forward, as it didn't require any extensive training or experience to operate.

The Results

During a large job, Dunn expanded 1,889 SA179 3/4" x 14 BWG tubes to conduct a comparison test between traditional rolling with an 850-style motor and parallel pin rolling with the Ultra Hawk system. Dunn realized the benefits the Ultra Hawk offers almost immediately. An 850 motor was used to roll 300 tubes with traditional expansion, at a 22 second cycle time, using one operator. The Ultra Hawk was used to roll 1,589 tubes, parallel pin expansion, at a four second cycle time, with one operator.

Dunn saw productivity increases not only in cycle times but also in tool life, with a 3:1 increase using the Ultra Hawk, versus a handheld motor with traditional rolling. Expansion consistency also increased with parallel pin, and the Ultra Hawk's

ability to measure torque resulted in no leaks at hydro. This is compared to the one leak of the 300 tubes rolled with traditional expansion using the 850 motor.

The ergonomics and safety of the system also had a positive impact on operators. "The torque of a push\pull certainly contributes to operator fatigue, but they can also be dangerous. Other designs on the market have a mounted roll motor located behind the operator with a rotating shaft that passes underneath the operator's arm. As you can imagine that shaft has the possibility of causing a major injury should someone's clothing or skin get caught," said Pete Dunn Jr. The pneumatic arm of the Ultra Hawk absorbs the weight and torque of the motor, reducing the risk of injury and fatigue on the job.

Overall, the Ultra Hawk system has helped Dunn realize the benefits of parallel pin expansion and how the system can provide a consistent and repeatable approach to tube expansion. As Pete Dunn Jr. explains, "with the speed increase of the new machine, I don't really see a reason to use tapered pin expansion on new fabrication anymore."

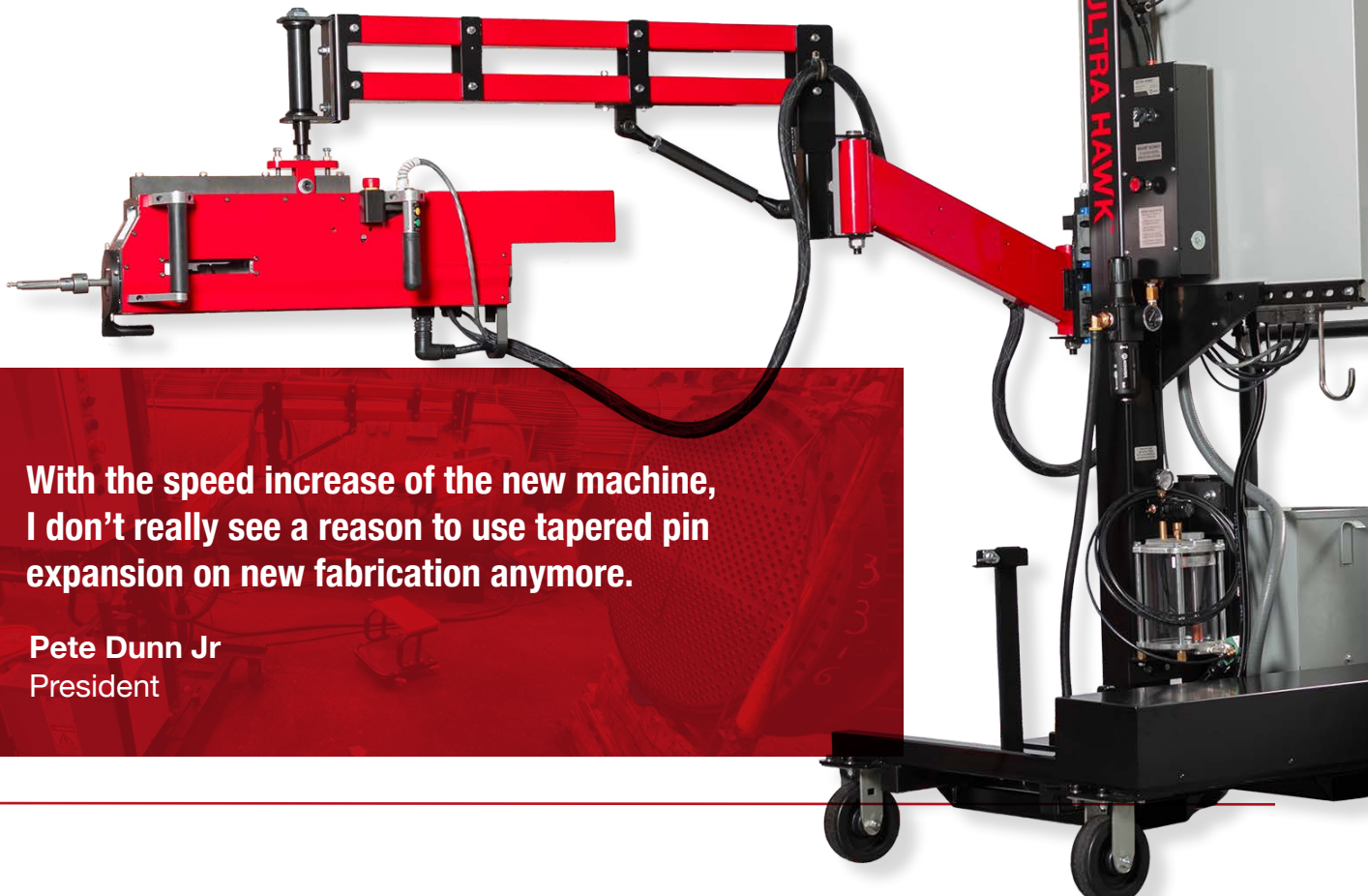

“ With the speed increase of the new machine, I don't really see a reason to use tapered pin expansion on new fabrication anymore.

Pete Dunn Jr
President

ULTRA HAWK™

Assisted Tube Rolling System

Tube Size

- 0.625" to 1.500" OD
- (15.9 to 38.1mm) OD



30% TUBE EXPANSION SAVINGS, GUARANTEED

Elliott's Ultra Hawk is the first of its kind. Offering the speed and productivity of an electric servo motor with the capability to perform parallel pin and traditional expansion. It maximizes productivity by providing the best in class cycle times and eliminating costly rework from less precise methods.

Experience the flexibility and speed of parallel pin rolling with the simple flip of a switch. True parallel pin rolling can reduce the stress created on welded tube joints compared to tapered rolling, making it ideal for certain applications.

The Ultra Hawk's articulated arm supports the weight and absorbs the torque of the rolling motor using a pneumatic counterbalance, which allows the operator to effortlessly move the motor into position.

Experience The Savings

The Ultra Hawk is the market's first truly complete system, guaranteed to save 30% in your tube expansion process.

A few ways you can save:

- Lower Maintenance Cost
- Faster speed and cycle times with parallel pin
- Ability to complete job requirements for both tapered pin and parallel pin
- Reduced labor, training, and set-up costs



THE FIRST TRULY COMPLETE SYSTEM.



Parallel Pin & Traditional Rolling Capability



Operator Friendly



Automatic Tool Lubrication

Increased Productivity

Servo Motor Technology

Equipped with the same proven electric servo motor technology used in CNC machines for decades. It reduces maintenance costs, while improving speed and durability.

Roll Traditional & Parallel Pin

Change between parallel pin and traditional rolling with the push of a button.

Lower Operating Costs

Experience up to 50% energy savings compared to air and hydraulic systems.

Eliminate Tube Sheet Warping

Parallel pin expansion reduces the force exerted against the tube and tube sheet, eliminating costly tube sheet damage and warping.

Up To 2X The Speed

Increase cycle times with parallel pin expansion and get up to twice the speed of tapered rolling.

Change Tooling Quickly

New quick change design allows for tooling change outs in less than a minute. The rotary lock design allows for easy removal with no tooling needed.

Operator Friendly

Operator Friendly Controls

Easy to use HMI allows for quick job setup and job saving capability.

Easy To Move

Heavy-duty casters, forklift pockets, and hoist ring provide a variety of methods to move the Hawk around the facility.

Consistent Tube Expansion

Roll Every Tube To Spec

System measures torque and controls system functions, allowing you to roll to the target wall reduction each time to eliminate costly re-rolling.

Record System Output

Ensure every tube is rolled to spec with torque data output. Quality control metrics ensure jobs meet customer requirements and pass hydro.

Maintain Tool Alignment

Expander holder increases tool life and ensures consistently rolled tubes with an expander holder that guides the expander and maintains tool alignment.

Longer Tool Life

Increase Expander Life

Swivel Mount securely supports the Power Head to relieve weight stress and increase expander life.

Safe & Ergonomic

Effortless Positioning

Upgraded mast and rail allows for easy positioning of the articulated arm, decreasing operator fatigue.

More Reach, Less Re-Adjusting

Large radial reach increases productivity by allowing a large area of tubes to be rolled without re-adjusting the unit.

Supports Tool Weight

Pneumatic counterbalance decreases operator fatigue by absorbing torque and allowing for effortless positioning of the arm and rolling motor.

Built-in Safety Features

Safety control valve protects the operator by eliminating a sudden drop of the articulated arm in case of pneumatic air loss.

Lubrication Where It's Needed

Spend less on consumables with through the cage Auto-Lubrication. The system increases tool life by providing lubrication exactly where it's needed.



ULTRA HAWK™

Assisted Tube Rolling System

ULTRA HAWK

| System Specifications | | | | |
|----------------------------------|------------------|-------------------------------|--|--|
| Tube OD Range | Torque | Speed | Weight | Dimensions |
| 5/8" - 1-1/2" (15.9 - 38.1mm) | 3.5 - 50 ft lbs. | 900 Max RPM Variable Speed | EPS230: 1,086 lbs. (492.6 Kg) EPS460: 1,269 lbs. (575.6 Kg) | 49" x 52" x 81" (1.24m x 1.32m x 2.06m) |

| Ultra Hawk Packages | | | |
|---------------------|---------|----------------------|---------------------------|
| Package | Voltage | Powerhead Spares Kit | Cable Cylinder Spares Kit |
| EPS230 | 230V | EPS100SK | EPS200SK |
| EPS460 | 460V | | |

Each Ultra Hawk Package includes the Ultra Hawk, Parallel Pin & Traditional Rolling Capability, Through The Cage Auto-Lubrication, Servo Motor Driven Power Head, and Swivel Mount System.

| Ultra Hawk Specifications | |
|------------------------------|---|
| Power | |
| Pneumatic Requirements | 1.5 CFM, 100 PSI |
| Power Requirements | EPS230: 230 V, 3 Phase, 60 Hz EPS460: 460 V, 3 Phase, 60 Hz |
| Specifications | |
| Horizontal Radius Reach | 5.5' (1.68 m) |
| Vertical Reach* | 2' - 5.5' (610mm - 1.68m) |
| Dimensions & Weight | |
| Working Area/Footprint* | 79" - 86" (2.01 - 1.68 m) height |
| | 43" (1.09 m) width |
| | 34" - 95" (864 mm - 2.41m) depth |
| Unit Weight | EPS230: 1,086 lbs. (492.6 Kg) EPS460: 1,269 lbs. (575.6 Kg) |
| Shipping Dimensions (crated) | 90" (2.29 m) height |
| | 66" (1.68 m) width |
| | 63" (1.60 m) depth |
| Shipping Weight (crated) | EPS230: 1,541 lbs. (699.0 Kg) EPS460: 1,650 lbs. (748.43 Kg) |

* Extended Reach Package Available Upon Request



Spares & Accessories

- P8395 & P8784 Tube Rolling Lubricant: See page 19 for part numbers.
- Cage Adapter: Connects the expander cage to the lubrication system and enables quick change functionality. One included with each expander.
- Lube Spacer w/ O-ring: One included with each expander. Seals the mandrel and back of cage adapter.



Cage Adapter & Lube Spacer

| Spares & Accessories | | |
|----------------------|--------------|---------------------|
| Expander | Cage Adapter | Lube Spacer 10-Pack |
| *25* | HX24CA375 | HX24LS25-10 |
| *26* | | HX24LS26-10 |
| *27* | | HX24LS27-10 |
| *28* | HX24CA437 | HX24LS28-10 |
| *29* | | HX24LS29-10 |
| *30* | | HX24LS30-10 |
| *31* | HX24CA500 | HX24LS31-10 |
| *32* | | HX24LS32-10 |
| *33* | | |
| *34* | HX24CA562 | HX24LS34-10 |
| *35* | | HX24LS35-10 |
| *36* | | |
| *38* | HX24CA625 | HX24LS36-10 |
| *39* | | |
| *40* | | HX24LS40-10 |
| *41* | | |
| *42* | | |
| *43* | HX24CA750 | HX24LS42-10 |
| *44* | | |
| *45* | | HX24LS45-10 |
| *46* | | HX24LS46-10 |
| *47* | | |
| *49* | HX24CA875 | HX24LS49-10 |
| *50* | | |
| *51* | | HX24LS51-10 |
| *52* | | |
| *53* | | HX24LS53-10 |
| *55* | HX24CA1000 | HX24LS55-10 |
| *56* | | HX24LS56-10 |
| *57* | | |
| *58* | | HX24LS58-10 |
| *59* | | HX24LS59-10 |
| *60* | | HX24LS60-10 |
| *61* | | |
| *63* | | |
| *64* | | HX24LS63-10 |
| *65* | | |

*Expander size (i.e. HX24229 or HX24129-8= *29*)



Traditional 3 Roll Condenser Expanders

Tube Size

- 0.625" to 1.500" OD
- (15.9 to 38.1mm) OD



**For additional reaches, add "-XX" to the end of the part number for desired length.
(ie. HT24131-12 signifies a 12" reach tool)**

| 3 Roll Expanders | | | | | | | | | | | | | | |
|------------------|----------------|-------------|-----------------|-------|--------|------|--|------------|-------------------------|--|------------|-------------------------|-------------------|-------------|
| Tube Size | | | Expansion Range | | | | Tube Sheet (Min/Max Reach 0.500" - 3.200" (12.7-81.3mm) Overall Roll Length 1-5/8" (41.3mm) **Overall Roll Length 1-1/2" (38.1mm) | | | Tube Sheet (Min/Max Reach 1.250" - 3.580" (31.8-90.9mm) Overall Roll Length 2-3/8" (60.3mm) ***Overall Roll Length 2-1/4" (57.15mm) | | | Common Mandrel | |
| OD | Wall Thickness | | Inch | | Metric | | Expander Assembly | | Roll Set (3 per set) | Expander Assembly | | Roll Set (3 per set) | | |
| | BWG | In | Metric | Min. | Max. | Min. | Max. | Flush | | 1/8" Recess | Flush | | | 1/8" Recess |
| 5/8" (15.9mm) | 12 | 0.109 | 2.77 | 0.392 | 0.447 | 10.0 | 11.3 | HT24125 | HT24125RB8 | 241R25-3** | HT24225 | HT24225RB8 | 242R25-3*** | 24ML25 |
| | 13 | 0.095 | 2.41 | 0.425 | 0.482 | 10.8 | 12.3 | HT24127 | HT24127RB8 | 241R27-3** | HT24227 | HT24227RB8 | 242R27-3*** | 24ML27 |
| | 14 | 0.083 | 2.11 | 0.449 | 0.506 | 11.4 | 12.8 | HT24128 | HT24128RA8 | 241R28-3 | HT24228 | HT24228RA8 | 242R28-3 | 24ML28 |
| | 15 | 0.072 | 1.83 | 0.471 | 0.524 | 12.0 | 13.3 | HT24129 | HT24129RA8 | 241R29-3 | HT24229 | HT24229RA8 | 242R29-3 | 24ML29 |
| | 16 | 0.065 | 1.65 | 0.485 | 0.538 | 12.3 | 13.7 | HT24129B | HT24129BRA8 | | HT24229B | HT24229BRA8 | | |
| | 17 | 0.058 | 1.47 | 0.499 | 0.564 | 12.7 | 14.3 | HT24130 | HT24130RA8 | 241R30-3 | HT24230 | HT24230RA8 | 242R30-3 | 24ML30 |
| | 18-19 | 0.049-0.042 | 1.24-1.07 | 0.517 | 0.584 | 13.1 | 14.8 | HT24131 | HT24131RA8 | 241R31-3 | HT24231 | HT24231RA8 | 242R31-3 | 24ML31 |
| | 20-22 | 0.035-0.028 | 0.89-0.71 | 0.540 | 0.609 | 13.7 | 15.5 | HT24132 | HT24132RA8 | 241R32-3 | HT24232 | HT24232RA8 | 242R32-3 | 24ML32 |
| 3/4" (19.1mm) | 10 | 0.134 | 3.40 | 0.471 | 0.538 | 12.0 | 13.7 | HT24129 | HT24129RB8 | 241R29-3 | HT24229 | HT24229RB8 | 242R29-3 | 24ML29 |
| | 11 | 0.120 | 3.05 | 0.499 | 0.564 | 12.7 | 14.3 | HT24130 | HT24130RB8 | 241R30-3 | HT24230 | HT24230RB8 | 242R30-3 | 24ML30 |
| | 12 | 0.109 | 2.77 | 0.517 | 0.584 | 13.1 | 14.8 | HT24131 | HT24131RB8 | 241R31-3 | HT24231 | HT24231RB8 | 242R31-3 | 24ML31 |
| | 13 | 0.095 | 2.41 | 0.540 | 0.609 | 13.7 | 15.5 | HT24132 | HT24132RB8 | 241R32-3 | HT24232 | HT24232RB8 | 242R32-3 | 24ML32 |
| | 14 | 0.083 | 2.11 | 0.562 | 0.631 | 14.3 | 16.0 | HT24133 | HT24133RA8 | 241R33-3 | HT24233 | HT24233RA8 | 242R33-3 | |
| | 15-16 | 0.072-0.065 | 1.83-1.65 | 0.592 | 0.672 | 15.0 | 17.1 | HT24134 | HT24134RA8 | 241R34-3 | HT24234 | HT24234RA8 | 242R34-3 | 24ML34 |
| | 17-18 | 0.058-0.049 | 1.47-1.24 | 0.620 | 0.697 | 15.7 | 17.7 | HT24135 | HT24135RA8 | 241R35-3 | HT24235 | HT24235RA8 | 242R35-3 | 24ML35 |
| | 19-22 | 0.042-0.028 | 1.07-0.71 | 0.641 | 0.731 | 16.3 | 18.6 | HT24136 | HT24136RA8 | 241R36-3 | HT24236 | HT24236RA8 | 242R36-3 | 24ML36 |
| 7/8" (22.2mm) | 10 | 0.134 | 3.40 | 0.592 | 0.672 | 15.0 | 17.1 | HT24134 | HT24134RB8 | 241R34-3 | HT24234 | HT24234RB8 | 242R34-3 | 24ML34 |
| | 11 | 0.120 | 3.05 | 0.620 | 0.697 | 15.7 | 17.7 | HT24135 | HT24135RB8 | 241R35-3 | HT24235 | HT24235RB8 | 242R35-3 | 24ML35 |
| | 12 | 0.109 | 2.77 | 0.641 | 0.731 | 16.3 | 18.6 | HT24136 | HT24136RB8 | 241R36-3 | HT24236 | HT24236RB8 | 242R36-3 | 24ML36 |
| | 13 | 0.095 | 2.41 | 0.655 | 0.745 | 16.6 | 18.9 | HT24138 | HT24138RA8 | 241R38-3 | HT24238 | HT24238RA8 | 242R38-3 | |
| | 14 | 0.083 | 2.11 | 0.675 | 0.765 | 17.1 | 19.4 | HT24139 | HT24139RA8 | 241R39-3 | HT24239 | HT24239RA8 | 242R39-3 | 24ML40 |
| | 15-16 | 0.072-0.065 | 1.83-1.65 | 0.715 | 0.800 | 18.2 | 20.3 | HT24140 | HT24140RA8 | | HT24240 | HT24240RA8 | | |
| | 17-19 | 0.058-0.049 | 1.47-1.07 | 0.743 | 0.828 | 18.9 | 21.0 | HT24141 | HT24141RA8 | 241R41-3 | HT24241 | HT24241RA8 | 242R41-3 | 24ML42 |
| | 20-22 | 0.035-0.028 | 0.89-0.71 | 0.795 | 0.865 | 20.2 | 22.0 | HT24142 | HT24142RA8 | 241R42-3 | HT24242 | HT24242RA8 | 242R42-3 | 24ML42 |
| 1" (25.4mm) | 8 | 0.165 | 4.19 | 0.655 | 0.745 | 16.6 | 18.9 | HT24138 | HT24138RB8 | 241R38-3 | HT24238 | HT24238RB8 | 242R38-3 | 24ML36 |
| | 9 | 0.148 | 3.76 | 0.675 | 0.765 | 17.1 | 19.4 | HT24139 | HT24139RB8 | | HT24239 | HT24239RB8 | | |
| | 10 | 0.134 | 3.40 | 0.715 | 0.800 | 18.2 | 20.3 | HT24140 | HT24140RB8 | 241R39-3 | HT24240 | HT24240RB8 | 242R39-3 | 24ML40 |
| | 11 | 0.120 | 3.05 | 0.743 | 0.828 | 18.9 | 21.0 | HT24141 | HT24141RB8 | | 241R41-3 | HT24241 | | |
| | 12-13 | 0.109-0.095 | 2.77-2.41 | 0.769 | 0.866 | 19.5 | 22.0 | HT24143 | HT24143RA8 | 241R42-3 | HT24243 | HT24243RA8 | 242R42-3 | 24ML43 |
| | 14 | 0.083 | 2.11 | 0.799 | 0.896 | 20.3 | 22.7 | HT24144 | HT24144RA8 | 241R44-3 | HT24244 | HT24244RA8 | 242R44-3 | |
| | 15-16 | 0.072-0.065 | 1.83-1.65 | 0.841 | 0.922 | 21.4 | 23.4 | HT24145 | HT24145RA8 | | HT24245 | HT24245RA8 | | 24ML45 |
| | 17-19 | 0.058-0.042 | 1.47-1.07 | 0.872 | 0.968 | 22.1 | 24.6 | HT24146 | HT24146RA8 | 241R46-3 | HT24246 | HT24246RA8 | 242R46-3 | 24ML46 |
| 20-22 | 0.035-0.028 | 0.89-0.71 | 0.894 | 0.990 | 22.7 | 25.2 | HT24147 | HT24147RA8 | 241R47-3 | HT24247 | HT24247RA8 | 242R47-3 | | |



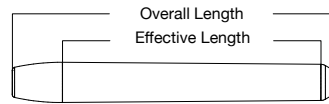

| Long Reach PN | Actual Max Reach | | Roll Part Number | Overall Roll Length | Effective Roll Length |
|---------------|-------------------|-------------------|------------------|---------------------|-----------------------|
| | Short Roll | Long Roll | | | |
| -8 | 7.200" (182.9mm) | 7.580" (192.5mm) | 241R25 - 241R27 | 1.500" (38.1mm) | 1.187" (30.1mm) |
| -12 | 11.200" (284.5mm) | 11.580" (294.1mm) | 241R28 - 241R42 | 1.625" (41.3mm) | 1.301" (33.0mm) |
| | | | 241R43 - 241R65 | | 1.239" (31.5mm) |
| -18 | 17.200" (436.9mm) | 17.580" (446.5mm) | 242R21 - 242R27 | 2.250" (57.2mm) | 1.937" (49.2mm) |
| | | | 242R28 - 242R42 | | 2.051" (52.1mm) |
| | | | 242R43 - 242R65 | 2.365" (60.3mm) | 1.989" (50.5mm) |

| 3 Roll Expanders | | | | | | | | | | | | | | |
|--------------------|----------------|-------------|-----------------|-------|--------|------|---|---------|-------------------------|-------------------|---|-------------------------|-------------|----------------|
| Tube Size | | | Expansion Range | | | | Tube Sheet (Min/Max Reach) 0.500" - 3.200" (12.7-81.3mm) Overall Roll Length 1-5/8" (41.3mm) **Overall Roll Length 1-1/2" (38.1mm) | | | | Tube Sheet (Min/Max Reach) 1.250" - 3.580" (31.8-90.9mm) Overall Roll Length 2-3/8" (60.3mm) ***Overall Roll Length 2-1/4" (57.15mm) | | | Common Mandrel |
| OD | Wall Thickness | | Inch | | Metric | | Expander Assembly | | Roll Set (3 per set) | Expander Assembly | | Roll Set (3 per set) | | |
| | BWG | In | Metric | Min. | Max. | Min. | Max. | Flush | | 1/8" Recess | Flush | | 1/8" Recess | |
| 1-1/8" (28.6mm) | 8 | 0.165 | 4.19 | 0.769 | 0.866 | 19.5 | 22.0 | HT24143 | HT24143RB8 | 241R42-3 | HT24243 | HT24243RB8 | 242R42-3 | 24ML43 |
| | 9 | 0.148 | 3.76 | 0.799 | 0.896 | 20.3 | 22.7 | HT24144 | HT24144RB8 | 241R44-3 | HT24244 | HT24244RB8 | 242R44-3 | |
| | 10 | 0.134 | 3.40 | 0.841 | 0.922 | 21.4 | 23.4 | HT24145 | HT24145RB8 | | HT24245 | HT24245RB8 | | 24ML45 |
| | 11-12 | 0.120-0.109 | 3.05-2.77 | 0.872 | 0.968 | 22.1 | 24.6 | HT24146 | HT24146RB8 | 241R46-3 | HT24246 | HT24246RB8 | 242R46-3 | 24ML46 |
| | 13 | 0.095 | 2.41 | 0.894 | 1.009 | 22.7 | 25.6 | HT24149 | HT24149RA8 | 241R47-3 | HT24249 | HT24249RA8 | 242R47-3 | 24ML49 |
| | 14-15 | 0.083-0.072 | 2.11-1.83 | 0.924 | 1.039 | 23.5 | 26.4 | HT24150 | HT24150RA8 | 241R50-3 | HT24250 | HT24250RA8 | 242R50-3 | |
| | 16-18 | 0.065-0.049 | 1.65-1.24 | 0.978 | 1.078 | 24.8 | 27.4 | HT24151 | HT24151RA8 | | HT24251 | HT24251RA8 | | 24ML51 |
| 1-1/4" (31.8mm) | 8 | 0.165 | 4.19 | 0.894 | 1.009 | 22.7 | 25.6 | HT24149 | HT24149RB8 | 241R47-3 | HT24249 | HT24249RB8 | 242R47-3 | 24ML49 |
| | 9 | 0.148 | 3.76 | 0.924 | 1.039 | 23.5 | 26.4 | HT24150 | HT24150RB8 | 241R50-3 | HT24250 | HT24250RB8 | 242R50-3 | |
| | 10-11 | 0.134-0.120 | 3.40-3.05 | 0.962 | 1.083 | 24.4 | 27.5 | HT24153 | HT24153RA8 | 241R53-3 | HT24253 | HT24253RA8 | 242R53-3 | 24ML53 |
| | 12-13 | 0.109-0.095 | 2.77-2.41 | 1.012 | 1.128 | 25.7 | 28.7 | HT24155 | HT24155RA8 | 241R52-3 | HT24255 | HT24255RA8 | 242R52-3 | 24ML55 |
| | 14-17 | 0.083-0.058 | 2.11-1.47 | 1.066 | 1.195 | 27.1 | 30.3 | HT24156 | HT24156RA8 | 241R56-3 | HT24256 | HT24256RA8 | 242R56-3 | 24ML56 |
| | 18-22 | 0.049-0.028 | 1.24-0.71 | 1.112 | 1.240 | 28.2 | 31.5 | HT24157 | HT24157RA8 | 241R57-3 | HT24257 | HT24257RA8 | 242R57-3 | |
| 1-3/8" (34.9mm) | 8 | 0.165 | 4.19 | 1.012 | 1.128 | 25.7 | 28.7 | HT24155 | HT24155RB8 | 241R52-3 | HT24255 | HT24255RB8 | 242R52-3 | 24ML55 |
| | 9-10 | 0.148-0.134 | 3.76-3.40 | 1.066 | 1.195 | 27.1 | 30.3 | HT24156 | HT24156RB8 | 241R56-3 | HT24256 | HT24256RB8 | 242R56-3 | 24ML56 |
| | 11 | 0.120 | 3.05 | 1.115 | 1.218 | 28.3 | 30.9 | HT24158 | HT24158RA8 | 241R58-3 | HT24258 | HT24258RA8 | 242R58-3 | 24ML58 |
| | 12-13 | 0.109-0.095 | 2.77-2.41 | 1.127 | 1.263 | 28.6 | 32.1 | HT24159 | HT24159RA8 | 241R57-3 | HT24259 | HT24259RA8 | 242R57-3 | 24ML59 |
| | 14-17 | 0.083-0.058 | 2.11-1.47 | 1.180 | 1.322 | 30.0 | 33.6 | HT24160 | HT24160RA8 | 241R60-3 | HT24260 | HT24260RA8 | 242R60-3 | 24ML60 |
| | 18-22 | 0.049-0.028 | 1.24-0.71 | 1.224 | 1.365 | 31.1 | 34.7 | HT24161 | HT24161RA8 | 241R61-3 | HT24261 | HT24261RA8 | 242R61-3 | |
| 1-1/2" (38.1mm) | 8 | 0.165 | 4.19 | 1.127 | 1.263 | 28.6 | 32.1 | HT24159 | HT24159RB8 | 241R57-3 | HT24259 | HT24259RB8 | 242R57-3 | 24ML59 |
| | 9-10 | 0.148-0.134 | 3.76-3.40 | 1.180 | 1.322 | 30.0 | 33.6 | HT24160 | HT24160RB8 | 241R60-3 | HT24260 | HT24260RB8 | 242R60-3 | 24ML60 |
| | 11-12 | 0.120-0.109 | 3.05-2.77 | 1.224 | 1.365 | 31.1 | 34.7 | HT24161 | HT24161RB8 | 241R61-3 | HT24261 | HT24261RB8 | 242R61-3 | |
| | 13-14 | 0.095-0.083 | 2.41-2.11 | 1.285 | 1.415 | 32.6 | 35.9 | HT24163 | HT24163RA8 | | HT24263 | HT24263RA8 | | |
| | 15-17 | 0.072-0.058 | 1.83-1.47 | 1.325 | 1.455 | 33.7 | 36.9 | HT24164 | HT24164RA8 | 241R64-3 | HT24264 | HT24264RA8 | 242R64-3 | 24ML63 |
| | 18-22 | 0.049-0.028 | 1.24-0.71 | 1.361 | 1.490 | 34.6 | 37.9 | HT24165 | HT24165RA8 | 241R65-3 | HT24265 | HT24265RA8 | 242R65-3 | |



ULTRA HAWK™

Parallel Pin 3 Roll Condenser Expanders

Tube Size

- 0.625" to 1.500" OD
- (15.9 to 38.1mm) OD



**For additional reaches, add "-XX" to the end of the part number for desired length.
(ie. HX24131-12 signifies a 12" reach tool)**

| 3 Roll Expanders | | | | | | | | | | | | | | |
|------------------|----------------|-------------|-----------------|-------|-------|--------|--|-------------------|-------------|-------------------------|--|-------------|-------------------------|----------------|
| Tube Size | | | Expansion Range | | | | Tube Sheet (Min/Max Reach 0.500" - 3.200" (12.7-81.3mm) Overall Roll Length 1-5/8" (41.3mm) **Overall Roll Length 1-1/2" (38.1mm) | | | | Tube Sheet (Min/Max Reach 1.250" - 3.580" (31.8-90.9mm) Overall Roll Length 2-3/8" (60.3mm) ***Overall Roll Length 2-1/4" (57.15mm) | | | Common Mandrel |
| OD | Wall Thickness | | | Inch | | Metric | | Expander Assembly | | Roll Set (3 per set) | Expander Assembly | | Roll Set (3 per set) | |
| | BWG | In | Metric | Min. | Max. | Min. | Max. | Flush | 1/8" Recess | | Flush | 1/8" Recess | | |
| 5/8" (15.9mm) | 12 | 0.109 | 2.77 | 0.392 | 0.447 | 10.0 | 11.3 | HX24125 | HX24125RB8 | 241R25-3** | HX24225 | HX24225RB8 | 242R25-3*** | 24ML25 |
| | 13 | 0.095 | 2.41 | 0.425 | 0.482 | 10.8 | 12.3 | HX24127 | HX24127RB8 | 241R27-3** | HX24227 | HX24227RB8 | 242R27-3*** | 24ML27 |
| | 14 | 0.083 | 2.11 | 0.449 | 0.506 | 11.4 | 12.8 | HX24128 | HX24128RA8 | 241R28-3 | HX24228 | HX24228RA8 | 242R28-3 | 24ML28 |
| | 15 | 0.072 | 1.83 | 0.471 | 0.524 | 12.0 | 13.3 | HX24129 | HX24129RA8 | 241R29-3 | HX24229 | HX24229RA8 | 242R29-3 | 24ML29 |
| | 16 | 0.065 | 1.65 | 0.485 | 0.538 | 12.3 | 13.7 | HX24129B | HX24129BRA8 | | HX24229B | HX24229BRA8 | | |
| | 17 | 0.058 | 1.47 | 0.499 | 0.564 | 12.7 | 14.3 | HX24130 | HX24130RA8 | 241R30-3 | HX24230 | HX24230RA8 | 242R30-3 | 24ML30 |
| | 18-19 | 0.049-0.042 | 1.24-1.07 | 0.517 | 0.584 | 13.1 | 14.8 | HX24131 | HX24131RA8 | 241R31-3 | HX24231 | HX24231RA8 | 242R31-3 | 24ML31 |
| 20-22 | 0.035-0.028 | 0.89-0.71 | 0.540 | 0.609 | 13.7 | 15.5 | HX24132 | HX24132RA8 | 241R32-3 | HX24232 | HX24232RA8 | 242R32-3 | 24ML32 | |
| 3/4" (19.1mm) | 10 | 0.134 | 3.40 | 0.471 | 0.538 | 12.0 | 13.7 | HX24129 | HX24129RB8 | 241R29-3 | HX24229 | HX24229RB8 | 242R29-3 | 24ML29 |
| | 11 | 0.120 | 3.05 | 0.499 | 0.564 | 12.7 | 14.3 | HX24130 | HX24130RB8 | 241R30-3 | HX24230 | HX24230RB8 | 242R30-3 | 24ML30 |
| | 12 | 0.109 | 2.77 | 0.517 | 0.584 | 13.1 | 14.8 | HX24131 | HX24131RB8 | 241R31-3 | HX24231 | HX24231RB8 | 242R31-3 | 24ML31 |
| | 13 | 0.095 | 2.41 | 0.540 | 0.609 | 13.7 | 15.5 | HX24132 | HX24132RB8 | 241R32-3 | HX24232 | HX24232RB8 | 242R32-3 | 24ML32 |
| | 14 | 0.083 | 2.11 | 0.562 | 0.631 | 14.3 | 16.0 | HX24133 | HX24133RA8 | 241R33-3 | HX24233 | HX24233RA8 | 242R33-3 | |
| | 15-16 | 0.072-0.065 | 1.83-1.65 | 0.592 | 0.672 | 15.0 | 17.1 | HX24134 | HX24134RA8 | 241R34-3 | HX24234 | HX24234RA8 | 242R34-3 | 24ML34 |
| | 17-18 | 0.058-0.049 | 1.47-1.24 | 0.620 | 0.697 | 15.7 | 17.7 | HX24135 | HX24135RA8 | 241R35-3 | HX24235 | HX24235RA8 | 242R35-3 | 24ML35 |
| 19-22 | 0.042-0.028 | 1.07-0.71 | 0.641 | 0.731 | 16.3 | 18.6 | HX24136 | HX24136RA8 | 241R36-3 | HX24236 | HX24236RA8 | 242R36-3 | 24ML36 | |
| 7/8" (22.2mm) | 10 | 0.134 | 3.40 | 0.592 | 0.672 | 15.0 | 17.1 | HX24134 | HX24134RB8 | 241R34-3 | HX24234 | HX24234RB8 | 242R34-3 | 24ML34 |
| | 11 | 0.120 | 3.05 | 0.620 | 0.697 | 15.7 | 17.7 | HX24135 | HX24135RB8 | 241R35-3 | HX24235 | HX24235RB8 | 242R35-3 | 24ML35 |
| | 12 | 0.109 | 2.77 | 0.641 | 0.731 | 16.3 | 18.6 | HX24136 | HX24136RB8 | 241R36-3 | HX24236 | HX24236RB8 | 242R36-3 | 24ML36 |
| | 13 | 0.095 | 2.41 | 0.655 | 0.745 | 16.6 | 18.9 | HX24138 | HX24138RA8 | 241R38-3 | HX24238 | HX24238RA8 | 242R38-3 | |
| | 14 | 0.083 | 2.11 | 0.675 | 0.765 | 17.1 | 19.4 | HX24139 | HX24139RA8 | 241R39-3 | HX24239 | HX24239RA8 | 242R39-3 | 24ML40 |
| | 15-16 | 0.072-0.065 | 1.83-1.65 | 0.715 | 0.800 | 18.2 | 20.3 | HX24140 | HX24140RA8 | | HX24240 | HX24240RA8 | | |
| | 17-19 | 0.058-0.049 | 1.47-1.07 | 0.743 | 0.828 | 18.9 | 21.0 | HX24141 | HX24141RA8 | 241R41-3 | HX24241 | HX24241RA8 | 242R41-3 | 24ML42 |
| 20-22 | 0.035-0.028 | 0.89-0.71 | 0.795 | 0.865 | 20.2 | 22.0 | HX24142 | HX24142RA8 | 241R42-3 | HX24242 | HX24242RA8 | 242R42-3 | 24ML42 | |
| 1" (25.4mm) | 8 | 0.165 | 4.19 | 0.655 | 0.745 | 16.6 | 18.9 | HX24138 | HX24138RB8 | 241R38-3 | HX24238 | HX24238RB8 | 242R38-3 | 24ML36 |
| | 9 | 0.148 | 3.76 | 0.675 | 0.765 | 17.1 | 19.4 | HX24139 | HX24139RB8 | 241R39-3 | HX24239 | HX24239RB8 | 242R39-3 | |
| | 10 | 0.134 | 3.40 | 0.715 | 0.800 | 18.2 | 20.3 | HX24140 | HX24140RB8 | | 241R41-3 | HX24240 | | HX24240RB8 |
| | 11 | 0.120 | 3.05 | 0.743 | 0.828 | 18.9 | 21.0 | HX24141 | HX24141RB8 | 241R42-3 | | HX24241 | HX24241RB8 | 242R42-3 |
| | 12-13 | 0.109-0.095 | 2.77-2.41 | 0.769 | 0.866 | 19.5 | 22.0 | HX24143 | HX24143RA8 | | 241R44-3 | HX24243 | HX24243RA8 | |
| | 14 | 0.083 | 2.11 | 0.799 | 0.896 | 20.3 | 22.7 | HX24144 | HX24144RA8 | HX24244 | | HX24244RA8 | | |
| | 15-16 | 0.072-0.065 | 1.83-1.65 | 0.841 | 0.922 | 21.4 | 23.4 | HX24145 | HX24145RA8 | 241R46-3 | HX24245 | HX24245RA8 | 242R46-3 | |
| | 17-19 | 0.058-0.042 | 1.47-1.07 | 0.872 | 0.968 | 22.1 | 24.6 | HX24146 | HX24146RA8 | | HX24246 | HX24246RA8 | | |
| 20-22 | 0.035-0.028 | 0.89-0.71 | 0.894 | 0.990 | 22.7 | 25.2 | HX24147 | HX24147RA8 | 241R47-3 | HX24247 | HX24247RA8 | 242R47-3 | 24ML46 | |



ULTRA HAWK

Parallel Pin 3 Roll Condenser Expanders

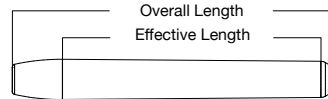

| Long Reach PN | Actual Max Reach | |
|---------------|-------------------|-------------------|
| | Short Roll | Long Roll |
| -8 | 7.200" (182.9mm) | 7.580" (192.5mm) |
| -12 | 11.200" (284.5mm) | 11.580" (294.1mm) |
| -18 | 17.200" (436.9mm) | 17.580" (446.5mm) |

| Roll Part Number | Overall Roll Length | Effective Roll Length |
|------------------|---------------------|-----------------------|
| 241R25 - 241R27 | 1.500" (38.1mm) | 1.187" (30.1mm) |
| 241R28 - 241R42 | 1.625" (41.3mm) | 1.301" (33.0mm) |
| 241R43 - 241R65 | | 1.239" (31.5mm) |
| 242R21 - 242R27 | 2.250" (57.2mm) | 1.937" (49.2mm) |
| 242R28 - 242R42 | 2.365" (60.3mm) | 2.051" (52.1mm) |
| 242R43 - 242R65 | | 1.989" (50.5mm) |

| 3 Roll Expanders | | | | | | | | | | | | | | | |
|--------------------|----------------|-------------|-----------------|-------|--------|------|---|------------|-------------------------|-------------------|---|-------------------------|-------------|----------|----------------|
| Tube Size | | | Expansion Range | | | | Tube Sheet (Min/Max Reach) 0.500" - 3.200" (12.7-81.3mm) Overall Roll Length 1-5/8" (41.3mm) **Overall Roll Length 1-1/2" (38.1mm) | | | | Tube Sheet (Min/Max Reach) 1.250" - 3.580" (31.8-90.9mm) Overall Roll Length 2-3/8" (60.3mm) ***Overall Roll Length 2-1/4" (57.15mm) | | | | Common Mandrel |
| OD | Wall Thickness | | Inch | | Metric | | Expander Assembly | | Roll Set (3 per set) | Expander Assembly | | Roll Set (3 per set) | | | |
| | BWG | In | Metric | Min. | Max. | Min. | Max. | Flush | | 1/8" Recess | Flush | | 1/8" Recess | | |
| 1-1/8" (28.6mm) | 8 | 0.165 | 4.19 | 0.769 | 0.866 | 19.5 | 22.0 | HX24143 | HX24143RB8 | 241R42-3 | HX24243 | HX24243RB8 | 242R42-3 | 24ML43 | |
| | 9 | 0.148 | 3.76 | 0.799 | 0.896 | 20.3 | 22.7 | HX24144 | HX24144RB8 | 241R44-3 | HX24244 | HX24244RB8 | 242R44-3 | | |
| | 10 | 0.134 | 3.40 | 0.841 | 0.922 | 21.4 | 23.4 | HX24145 | HX24145RB8 | | 241R46-3 | HX24245 | HX24245RB8 | 242R44-3 | 24ML45 |
| | 11-12 | 0.120-0.109 | 3.05-2.77 | 0.872 | 0.968 | 22.1 | 24.6 | HX24146 | HX24146RB8 | 241R50-3 | | HX24246 | HX24246RB8 | 242R46-3 | 24ML46 |
| | 13 | 0.095 | 2.41 | 0.894 | 1.009 | 22.7 | 25.6 | HX24149 | HX24149RA8 | | 241R47-3 | HX24249 | HX24249RA8 | 242R47-3 | 24ML49 |
| | 14-15 | 0.083-0.072 | 2.11-1.83 | 0.924 | 1.039 | 23.5 | 26.4 | HX24150 | HX24150RA8 | 241R52-3 | HX24250 | HX24250RA8 | 242R50-3 | | |
| | 16-18 | 0.065-0.049 | 1.65-1.24 | 0.978 | 1.078 | 24.8 | 27.4 | HX24151 | HX24151RA8 | | HX24251 | HX24251RA8 | 242R51-3 | 24ML51 | |
| 19-22 | 0.042-0.028 | 1.07-0.71 | 1.016 | 1.116 | 25.8 | 28.4 | HX24152 | HX24152RA8 | 241R52-3 | HX24252 | HX24252RA8 | 242R52-3 | | | |
| 1-1/4" (31.8mm) | 8 | 0.165 | 4.19 | 0.894 | 1.009 | 22.7 | 25.6 | HX24149 | HX24149RB8 | 241R47-3 | HX24249 | HX24249RB8 | 242R47-3 | 24ML49 | |
| | 9 | 0.148 | 3.76 | 0.924 | 1.039 | 23.5 | 26.4 | HX24150 | HX24150RB8 | 241R50-3 | HX24250 | HX24250RB8 | 242R50-3 | | |
| | 10-11 | 0.134-0.120 | 3.40-3.05 | 0.962 | 1.083 | 24.4 | 27.5 | HX24153 | HX24153RA8 | 241R53-3 | HX24253 | HX24253RA8 | 242R53-3 | 24ML53 | |
| | 12-13 | 0.109-0.095 | 2.77-2.41 | 1.012 | 1.128 | 25.7 | 28.7 | HX24155 | HX24155RA8 | 241R52-3 | HX24255 | HX24255RA8 | 242R52-3 | 24ML55 | |
| | 14-17 | 0.083-0.058 | 2.11-1.47 | 1.066 | 1.195 | 27.1 | 30.3 | HX24156 | HX24156RA8 | 241R56-3 | HX24256 | HX24256RA8 | 242R56-3 | 24ML56 | |
| 18-22 | 0.049-0.028 | 1.24-0.71 | 1.112 | 1.240 | 28.2 | 31.5 | HX24157 | HX24157RA8 | 241R57-3 | HX24257 | HX24257RA8 | 242R57-3 | | | |
| 1-3/8" (34.9mm) | 8 | 0.165 | 4.19 | 1.012 | 1.128 | 25.7 | 28.7 | HX24155 | HX24155RB8 | 241R52-3 | HX24255 | HX24255RB8 | 242R52-3 | 24ML55 | |
| | 9-10 | 0.148-0.134 | 3.76-3.40 | 1.066 | 1.195 | 27.1 | 30.3 | HX24156 | HX24156RB8 | 241R56-3 | HX24256 | HX24256RB8 | 242R56-3 | 24ML56 | |
| | 11 | 0.120 | 3.05 | 1.115 | 1.218 | 28.3 | 30.9 | HX24158 | HX24158RA8 | 241R58-3 | HX24258 | HX24258RA8 | 242R58-3 | 24ML58 | |
| | 12-13 | 0.109-0.095 | 2.77-2.41 | 1.127 | 1.263 | 28.6 | 32.1 | HX24159 | HX24159RA8 | 241R57-3 | HX24259 | HX24259RA8 | 242R57-3 | 24ML59 | |
| | 14-17 | 0.083-0.058 | 2.11-1.47 | 1.180 | 1.322 | 30.0 | 33.6 | HX24160 | HX24160RA8 | 241R60-3 | HX24260 | HX24260RA8 | 242R60-3 | 24ML60 | |
| 18-22 | 0.049-0.028 | 1.24-0.71 | 1.224 | 1.365 | 31.1 | 34.7 | HX24161 | HX24161RA8 | 241R61-3 | HX24261 | HX24261RA8 | 242R61-3 | | | |
| 1-1/2" (38.1mm) | 8 | 0.165 | 4.19 | 1.127 | 1.263 | 28.6 | 32.1 | HX24159 | HX24159RB8 | 241R57-3 | HX24259 | HX24259RB8 | 242R57-3 | 24ML59 | |
| | 9-10 | 0.148-0.134 | 3.76-3.40 | 1.180 | 1.322 | 30.0 | 33.6 | HX24160 | HX24160RB8 | 241R60-3 | HX24260 | HX24260RB8 | 242R60-3 | 24ML60 | |
| | 11-12 | 0.120-0.109 | 3.05-2.77 | 1.224 | 1.365 | 31.1 | 34.7 | HX24161 | HX24161RB8 | 241R61-3 | HX24261 | HX24261RB8 | 242R61-3 | | |
| | 13-14 | 0.095-0.083 | 2.41-2.11 | 1.285 | 1.415 | 32.6 | 35.9 | HX24163 | HX24163RA8 | | HX24263 | HX24263RA8 | 242R61-3 | 24ML63 | |
| | 15-17 | 0.072-0.058 | 1.83-1.47 | 1.325 | 1.455 | 33.7 | 36.9 | HX24164 | HX24164RA8 | 241R64-3 | HX24264 | HX24264RA8 | 242R64-3 | | |
| | 18-22 | 0.049-0.028 | 1.24-0.71 | 1.361 | 1.490 | 34.6 | 37.9 | HX24165 | HX24165RA8 | 241R65-3 | HX24265 | HX24265RA8 | 242R65-3 | | |

ULTRA HAWK



OPERATOR TRAINING

3 WAYS OPERATOR TRAINING CAN BENEFIT YOUR ORGANIZATION



EMPLOYEE TURNOVER is not a new phenomenon, but it has become more challenging for companies in recent years due to many global changes. Additionally, with many industries experiencing an increase in retirements, organizations are struggling with the loss of tribal or field knowledge. As a result, many companies are looking for better

ways to hire, train, and retain workers in the field, to make the process more efficient. Investing in regular employee trainings are a great way to train new employees, adopt more efficient processes, and ensure that the entire team is up to date on industry best practices.

1.

INCREASE OPERATOR RETENTION

Working in a niche market, it can be challenging to find new workers with field experience. This makes training critical for operator training and retention. Historically, many organizations would rely on workers with the most seniority to teach new hires how to successfully perform the job. While this is beneficial, having a formal training program can reduce the learning curve and ensure everyone is working to the same standard. For example, over time steps can be forgotten or changed, so it's important that everyone on the team have the option to refresh their skills. It also makes sure that everyone is aware of any technical advancements or changes that may have been made over the years to help make the job easier.

2.

IMPROVE ERGONOMICS & PRODUCTIVITY

In an industry as old as vessel fabrication and maintenance, there are many processes that have grown and adapted to make the job easier. Whether it's changes to the process or innovation in tooling, the industry has changed to better assist operators. For example, many boilermakers remember having to hand bead tubes using a pneumatic hammer and beading tool. This process can be extremely tiring and is difficult to teach those newer to the trade. In recent years, many companies have switched to a single roll beading expander, eliminating the need for hand beading. Not only does this reduce the amount of time it takes to roll and bead a vessel, but it's much easier for operators to use and get trained on. These types of innovative changes or improvements can be extremely beneficial for boosting job productivity, as well as, reducing labor and tooling costs. Lastly, this improvement in ergonomics can lower employee turnover, reducing the amount of time and money spent on hiring.

3.

LOWER JOB COSTS

Employee training programs can also reduce job costs and improve overall productivity. In addition to incorporating newer technology, trainings also help reinforce industry best practices. While each facility has different processes for how work is carried out, there are universal principles that can reduce job costs. For example, understanding proper set-up steps can reduce the amount of time required for the job and the amount of tooling required. This was exemplified in a recent training where the customer was retubing a heat exchanger. They ordered a huge supply of pulling spears, but their team wasn't trained on using anti-seize lubricant and proper sizing for spears, resulting in more money spent on the job. Now armed with this knowledge, they can lower future job costs, increase tool life, and improve productivity.



Overall, training programs can benefit all organizations, especially, those in competitive markets. From **improving operator retention, boosting productivity, and cutting job costs**, training is a great investment to ensure your staff is up to date on all the latest industry practices.

MONSTER HAWK™

3 Roll Parallel Pin Condenser Expanders

MONSTER HAWK



WHEN EVERY SECOND COUNTS.

True parallel pin rolling with the highest productivity of any system.

Elliott's Monster Hawk is a hydraulically driven parallel tube rolling system. Offering the speed, power and productivity of a hydraulic motor with the precision and control of an electronic system, it maximizes productivity by providing the fastest cycle times for mechanical expansion while eliminating costly rework from less precise methods.



MONSTER HAWK - PX24 Series

3 Roll Parallel Pin Condenser Expanders

Tube Size

- 0.750" to 1.000" OD
- (19.1 to 25.4mm) OD



| 3 Roll Monster Hawk Expanders | | | | | | | | | | | | | | | | |
|-------------------------------|----------------|-------------|-----------------|-------|--------|------|--|---------|-------------------------|-------------------|--|-------------------------|-------------|---------|----------------|-------------|
| Tube Size | | | Expansion Range | | | | Tube Sheet 3/4" - 3-3/4" (12.7-101.6mm) Overall Roll Length 1-5/8" (41.3mm) | | | | Tube Sheet 1-1/2" - 4-1/8" (31.8-111.1mm) Overall Roll Length 2-3/8" (60.3mm) | | | | Common Mandrel | Lube Spacer |
| OD | Wall Thickness | | Inch | | Metric | | Expander Assembly | | Roll Set (3 per set) | Expander Assembly | | Roll Set (3 per set) | | | | |
| | BWG | In | Metric | Min. | Max. | Min. | Max. | Flush | | 1/8" Recess | Flush | | 1/8" Recess | | | |
| 3/4" (19.1mm) | 10 | 0.134 | 3.40 | 0.471 | 0.538 | 12.0 | 13.7 | PX24129 | PX24129RB8 | 241R29-3 | PX24229 | PX24229RB8 | 242R29-3 | PX24M29 | PX24LS29 | |
| | 11 | 0.120 | 3.05 | 0.499 | 0.564 | 12.7 | 14.3 | PX24130 | PX24130RB8 | 241R30-3 | PX24230 | PX24230RB8 | 242R30-3 | PX24M30 | PX24LS30 | |
| | 12 | 0.109 | 2.77 | 0.517 | 0.584 | 13.1 | 14.8 | PX24131 | PX24131RB8 | 241R31-3 | PX24231 | PX24231RB8 | 242R31-3 | PX24M31 | PX24LS31 | |
| | 13 | 0.095 | 2.41 | 0.540 | 0.609 | 13.7 | 15.5 | PX24132 | PX24132RB8 | 241R32-3 | PX24232 | PX24232RB8 | 242R32-3 | PX24M32 | PX24LS32 | |
| | 14 | 0.083 | 2.11 | 0.562 | 0.631 | 14.3 | 16.0 | PX24133 | PX24133RA8 | 241R33-3 | PX24233 | PX24233RA8 | 242R33-3 | | | |
| | 15-16 | 0.072-0.065 | 1.83-1.65 | 0.592 | 0.672 | 15.0 | 17.1 | PX24134 | PX24134RA8 | 241R34-3 | PX24234 | PX24234RA8 | 242R34-3 | PX24M34 | PX24LS34 | |
| 1" (25.4mm) | 10 | 0.134 | 3.40 | 0.715 | 0.800 | 18.2 | 20.3 | PX24140 | PX24140RB8 | 241R39-3 | PX24240 | PX24240RB8 | 242R39-3 | PX24M40 | PX24LS40 | |
| | 11 | 0.120 | 3.05 | 0.743 | 0.828 | 18.9 | 21.0 | PX24141 | PX24141RB8 | 241R41-3 | PX24241 | PX24241RB8 | 242R41-3 | | | |
| | 12-13 | 0.109-0.095 | 2.77-2.41 | 0.769 | 0.866 | 19.5 | 22.0 | PX24143 | PX24143RA8 | 241R42-3 | PX24243 | PX24243RA8 | 242R42-3 | PX24M43 | PX24LS43 | |
| | 14 | 0.083 | 2.11 | 0.799 | 0.896 | 20.3 | 22.7 | PX24144 | PX24144RA8 | 241R44-3 | PX24244 | PX24244RA8 | 242R44-3 | | | |
| | 15-16 | 0.072-0.065 | 1.83-1.65 | 0.841 | 0.922 | 21.4 | 23.4 | PX24145 | PX24145RA8 | | PX24245 | PX24245RA8 | 242R44-3 | PX24M45 | PX24LS45 | |



| 3 Roll 8" Reach Monster Hawk Expanders | | | | | | | | | | | | | | | | |
|--|----------------|-------------|-----------------|-------|--------|------|--|-----------|-------------------------|-------------------|---|-------------------------|-------------|-----------|----------------|-------------|
| Tube Size | | | Expansion Range | | | | Tube Sheet 1/2" - 8" (12.7-203.2mm) Overall Roll Length 1-5/8" (41.3mm) | | | | Tube Sheet 1-1/4" - 8-3/8" (31.8-212.7mm) Overall Roll Length 2-3/8" (60.3mm) | | | | Common Mandrel | Lube Spacer |
| OD | Wall Thickness | | Inch | | Metric | | Expander Assembly | | Roll Set (3 per set) | Expander Assembly | | Roll Set (3 per set) | | | | |
| | BWG | In | Metric | Min. | Max. | Min. | Max. | Flush | | 1/8" Recess | Flush | | 1/8" Recess | | | |
| 3/4" (19.1mm) | 10 | 0.134 | 3.40 | 0.471 | 0.538 | 12.0 | 13.7 | PX24129-8 | PX24129RB8-8 | 241R29-3 | PX24229-8 | PX24229RB8-8 | 242R29-3 | PX24M29-8 | PX24LS29 | |
| | 11 | 0.120 | 3.05 | 0.499 | 0.564 | 12.7 | 14.3 | PX24130-8 | PX24130RB8-8 | 241R30-3 | PX24230-8 | PX24230RB8-8 | 242R30-3 | PX24M30-8 | PX24LS30 | |
| | 12 | 0.109 | 2.77 | 0.517 | 0.584 | 13.1 | 14.8 | PX24131-8 | PX24131RB8-8 | 241R31-3 | PX24231-8 | PX24231RB8-8 | 242R31-3 | PX24M31-8 | PX24LS31 | |
| | 13 | 0.095 | 2.41 | 0.540 | 0.609 | 13.7 | 15.5 | PX24132-8 | PX24132RB8-8 | 241R32-3 | PX24232-8 | PX24232RB8-8 | 242R32-3 | PX24M32-8 | PX24LS32 | |
| | 14 | 0.083 | 2.11 | 0.562 | 0.631 | 14.3 | 16.0 | PX24133-8 | PX24133RA8-8 | 241R33-3 | PX24233-8 | PX24233RA8-8 | 242R33-3 | | | |
| | 15-16 | 0.072-0.065 | 1.83-1.65 | 0.592 | 0.672 | 15.0 | 17.1 | PX24134-8 | PX24134RA8-8 | 241R34-3 | PX24234-8 | PX24234RA8-8 | 242R34-3 | PX24M34-8 | PX24LS34 | |
| 1" (25.4mm) | 10 | 0.134 | 3.40 | 0.715 | 0.800 | 18.2 | 20.3 | PX24140-8 | PX24140RB8-8 | 241R39-3 | PX24240-8 | PX24240RB8-8 | 242R39-3 | PX24M40-8 | PX24LS40 | |
| | 11 | 0.120 | 3.05 | 0.743 | 0.828 | 18.9 | 21.0 | PX24141-8 | PX24141RB8-8 | 241R41-3 | PX24241-8 | PX24241RB8-8 | 242R41-3 | | | |
| | 12-13 | 0.109-0.095 | 2.77-2.41 | 0.769 | 0.866 | 19.5 | 22.0 | PX24143-8 | PX24143RA8-8 | 241R42-3 | PX24243-8 | PX24243RA8-8 | 242R42-3 | PX24M43-8 | PX24LS43 | |
| | 14 | 0.083 | 2.11 | 0.799 | 0.896 | 20.3 | 22.7 | PX24144-8 | PX24144RA8-8 | 241R44-3 | PX24244-8 | PX24244RA8-8 | 242R44-3 | | | |
| | 15-16 | 0.072-0.065 | 1.83-1.65 | 0.841 | 0.922 | 21.4 | 23.4 | PX24145-8 | PX24145RA8-8 | | PX24245-8 | PX24245RA8-8 | 242R44-3 | PX24M45-8 | PX24LS45 | |



CLEAN



CONTENTS

- Jumbo Jiffy Gun **108**
- 5224XL & 5125 Series **110**
- Roto-Jet **114**
- Die-Hard **120**
- Soot Buster **124**
- Turbine Style Straight Tube Cleaners **128**
- Turbine Style Curved Tube Cleaners **135**
- Turbine Style Tube Cleaner Accessories **145**
- Vent Hole Cleaner..... **146**
- Operating Hoses **147**
- Turbine Style Aluminum Siphon Tube Cleaners **148**
- Gas Line Renewal..... **149**
- Pipe Rattling Equipment..... **150**
- ET Series Oil Field Pipeyard Cleaning Heads & Motors..... **151**

CLEANING UNKNOWN DEPOSITS IN HEAT EXCHANGERS & BOILERS

Navigating the challenge of unknown deposits in heat exchange equipment can be daunting. From shell and tube heat exchangers to air coolers and boilers, each system presents unique cleaning considerations. Being prepared is key to efficiently and effectively removing these deposits, minimizing downtime, and extending the lifespan of your equipment.

UNDERSTANDING YOUR EQUIPMENT & BYPRODUCTS

This initial assessment can provide crucial clues about the likely composition of the deposit.

For instance, if you're dealing with an air cooler, the chances are high that you're facing a calcium deposit. Air coolers often operate with water, and the evaporation process can leave behind hard, mineral-based scale. In such cases, a dry flush might be the preferred initial cleaning approach.

Shell and tube heat exchangers, especially those in offshore or petroleum-based units, are notorious for developing hard, crusty deposits, fouling, and scaling. The nature of the process fluids and the high temperatures involved contribute to the formation of tenacious, often hydrocarbon-based, residues.

Scotch marine boilers, commonly found on ships, have a unique challenge: organic but hard deposits like fish and mussels. These biological growths, stemming from the use of seawater, can create significant blockages and impede heat transfer.

By understanding the type of unit and the byproduct, you can significantly narrow down the potential types of deposits and the condition of the tubes.

Leveraging Past Experience & Anticipating Blockages

Once you have a better grasp of the equipment and its byproduct, it's wise to consider the historical context. Asking about previous cleaning methods and their effectiveness can offer invaluable insights. What worked well? What didn't? This information can guide your selection of the most suitable cleaning solution.

Another critical question is whether a full blockage is anticipated anywhere in the tubes. Full blockages require more aggressive cleaning strategies and can influence the type of tools and the number of passes required.

Navigating Space Constraints

Once you have a better grasp of the equipment and its byproduct, it's wise to consider the historical context. Asking about previous cleaning methods and their effectiveness can offer invaluable insights. What worked well? What didn't? This information can guide your selection of the most suitable cleaning solution.

Another critical question is whether a full blockage is anticipated anywhere in the tubes. Full blockages require more aggressive cleaning strategies and can influence the type of tools and the number of passes required.

Navigating Space Constraints

Once you have a better grasp of the equipment and its byproduct, it's wise to consider the historical context. Asking about previous cleaning methods and their effectiveness can offer invaluable insights. What worked well? What didn't? This information can guide your selection of the most suitable cleaning solution.

Another critical question is whether a full blockage is anticipated anywhere in the tubes. Full blockages require more aggressive cleaning strategies and can influence the type of tools and the number of passes required.

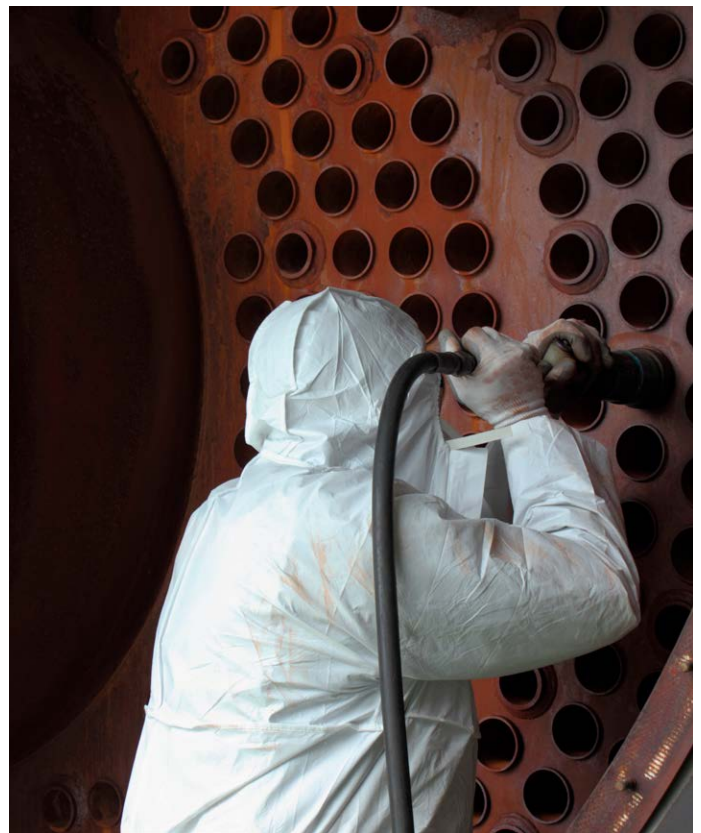

Considerations for Mechanical Cleaning

Regardless of the specific method chosen, especially when opting for mechanical cleaning, it's always recommended to have a range of tool sizes on hand. This means securing the next size up and down for drills, heads, and brushes. This accounts for the possibility of varying internal diameters (IDs) within the tubes due to different types of blockages or even manufacturing tolerances. It's also important to anticipate that multiple passes will likely be required to fully remove heavy deposits.

By understanding the equipment and its byproducts, leveraging past experiences, considering space limitations, and being prepared with a range of tools – you can significantly improve your readiness for cleaning unknown deposits, ultimately leading to more efficient and effective maintenance outcomes.

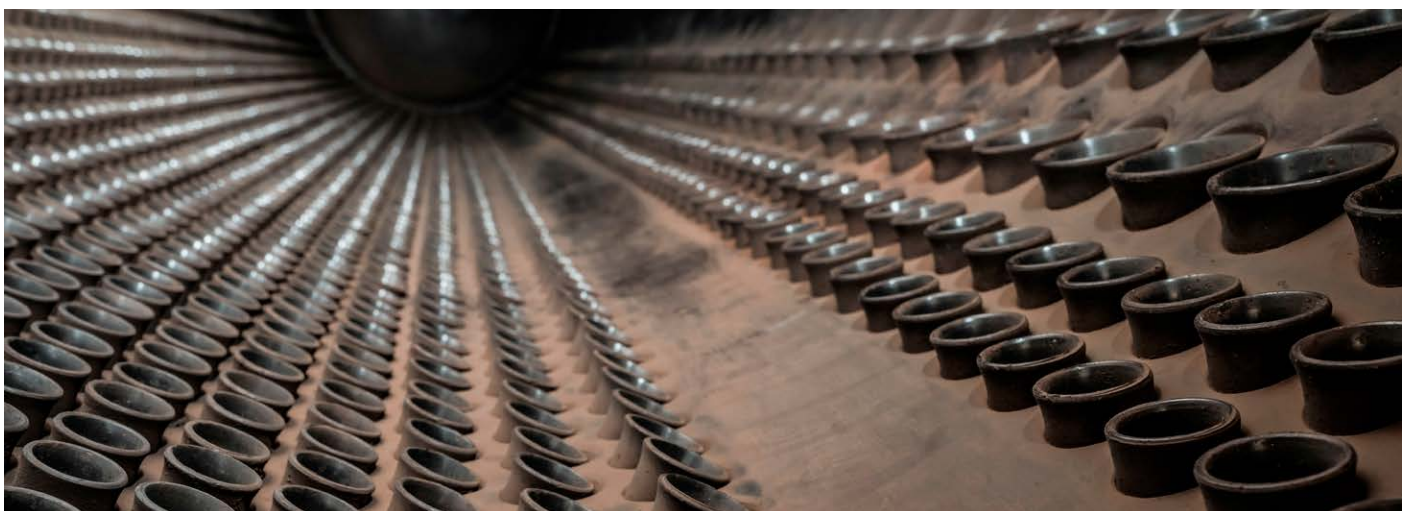

JUMBO JIFFY GUN

Shoot Through Tube Cleaning System

Tube Size

- 3/8" to 1-1/4" OD
- 9.5 to 31.8mm OD

Tube Section

- Straight

Type

- Soft, gummy or organic

Thickness

- Light
- Medium

Flush

- Wet

The Jumbo Jiffy Gun is powered by an air and water combination to propel a wide range of reusable shoot through devices. Soft deposits such as mud and algae are removed from the tube in seconds!

Elliott's Jumbo Jiffy Gun Tube Cleaning System is the preferred method for cleaning condenser tubes in power utility plants, pulp, paper, steel mills and petrochemical plants.

Features & Benefits:

- Tapered nozzle covers wide range of sizes eliminating need for multiple nozzle sizes.
- Utilizes reusable shoot through devices for lower cost.
- Cleans without damaging tubes.
- On board pet cock to relieve pressure in clogged tubes.

Spares & Accessories:

- 5371CL Lexan Shield*
- Tapered Nozzle (See table on right.)*
- 5371NA Nozzle Adapter*
- P5371N15 Air Hose Whip 15' (4.6M) Long
- P5371N25 Air Hose Whip 25' (7.6M) Long
- P5371N50 Air Hose Whip 50' (15.2M) Long
- P5371N100 Air Hose Whip 100' (30.5M) Long
- P5224-12-15 Water Hose Whip 15' (4.6M) Long
- P5224-12-25 Water Hose Whip 25' (7.6M) Long
- P5224-12-50 Water Hose Whip 50' (15.2M) Long
- P5224-12-100 Water Hose Whip 100' (30.5M) Long

* Included In Kit



Jiffy Gun Kit includes:

- Jumbo Jiffy Gun and Tapered Nozzle Assembly
- Tapered Nozzle
- Nozzle Adapter
- Lexan Shield
- 7-1/2' (2.3M) Water Hose Whip
- 7-1/2' (2.3M) Air Hose Whip
- Carrying Case

| Tube OD | | Kit Number | Tapered Nozzle | Air Pressure | Max Water Pressure | Weight |
|-----------------|----------|------------|----------------|----------------------------|---------------------|---------------------|
| Inch | mm | | | | | |
| 3/8" - 1/2" | 9.5-12.7 | 5371CK0 | 5371-0608 | 45-90 PSI (3.1-6.2 bar) | 50 PSI (3.4 bar) | 3.5 lbs (1.6 Kg) |
| 3/4" | 19 | 5371CK1 | 5371-12 | | | |
| 7/8" - 1" | 22-25 | 5371CK2 | 5371-1416 | | | |
| 1-1/8" - 1-1/4" | 26-32 | 5371CK3 | 5371-1820 | | | |



JUMBO JIFFY GUN

Shoot Through Cleaners



5022 Series

Shoot through brush commonly used for soft and organic deposits with light thickness.

| Tube OD | BWG | Part # | Tube OD | BWG | Part # |
|------------------|-----|----------|--------------------|-----|-----------|
| 1/2" (12.7mm) | 12 | 5022-312 | 7/8" (22.2mm) | 12 | 5022-687 |
| | 13 | | | 13 | |
| | 14 | 5022-342 | | 14 | 5022-730 |
| | 15 | 5022-375 | | 15 | 5022-750 |
| | 16 | | | 16 | |
| | 17 | 5022-396 | | 17 | 5022-782 |
| | 18 | 5022-437 | | 18 | 5022-812 |
| | 19 | | | 19 | |
| | 20 | | | 20 | |
| | 21 | 5022-460 | | 21 | 5022-845 |
| 22 | 22 | | | | |
| 5/8" (15.9mm) | 12 | 5022-437 | 1" (25.4mm) | 12 | 5022-812 |
| | 13 | | | 13 | |
| | 14 | 5022-472 | | 14 | 5022-858 |
| | 15 | 5022-500 | | 15 | 5022-875 |
| | 16 | | | 16 | |
| | 17 | 5022-524 | | 17 | 5022-912 |
| | 18 | 5022-562 | | 18 | 5022-937 |
| | 19 | | | 19 | |
| | 20 | | | 20 | |
| | 21 | 5022-580 | | 21 | 5022-975 |
| 22 | 22 | | | | |
| 3/4" (19.1mm) | 12 | 5022-562 | 1-1/8" (28.6mm) | 12 | 5022-937 |
| | 13 | | | 13 | |
| | 14 | 5022-602 | | 14 | 5022-985 |
| | 15 | 5022-625 | | 15 | 5022-1000 |
| | 16 | | | 16 | |
| | 17 | 5022-654 | | 17 | 5022-1041 |
| | 18 | 5022-687 | | 18 | 5022-1057 |
| | 19 | | | 19 | 5022-1076 |
| | 20 | | | 20 | |
| | 21 | 5022-715 | | 21 | 5022-1091 |
| 22 | 22 | | | | |

JUMBO JIFFY GUN



5224XL & 5125 SERIES

Heat Exchanger Cleaners

Tube Size

- 0.345" to 1.902" ID
- 8.76mm to 48.31mm ID

Tube Section

- Straight

Type

- Soft, gummy or organic
- Hard powder
- Rock solid

Thickness

- Light
- Medium
- Heavy

Flush

- Wet
- Dry

Elliott Tool's Heat Exchanger Tube Cleaners utilize a rigid shaft to provide high torque cleaning to remove hard deposits often found in heat exchanger tubes. These cleaners are ideal for use in sugar mills, paper mills, chemical plants, and oil refineries.

The trigger-operated cleaner features an air-powered motor that remains external to the tube, providing a powerful rotary motion to the shaft and cleaning tool. The 5224XL utilizes water flush operation to wash away all those loose deposits.

Air purge models are also available for any cleaning application where water flush can not be used. Contact Customer Service for details.

Features & Benefits:

- High torque for hard or gummy deposits.
- 5125 heavy duty motor ideal for refineries.
- Standard model features water flush operation, convenient for flushing away loose deposits.
- Lightweight and powerful.
- Safer & much less expensive than water blasting.

Spares & Accessories:

- P5370N 7-1/2 ft. (2.3M) Water Hose Whip (for 5224XL)
- P5224-12 7-1/2 ft. (2.3M) Air Hose Whip (for 5224XL)
- 835200-25 25 ft. (7.6M) Air Hose Whip (for 5125)
- 835200-50 50 ft. (15.2M) Air Hose Whip (for 5125)
- 512513 Paddles (1 set) (for 5125)
- See page 112 for brushes & drills

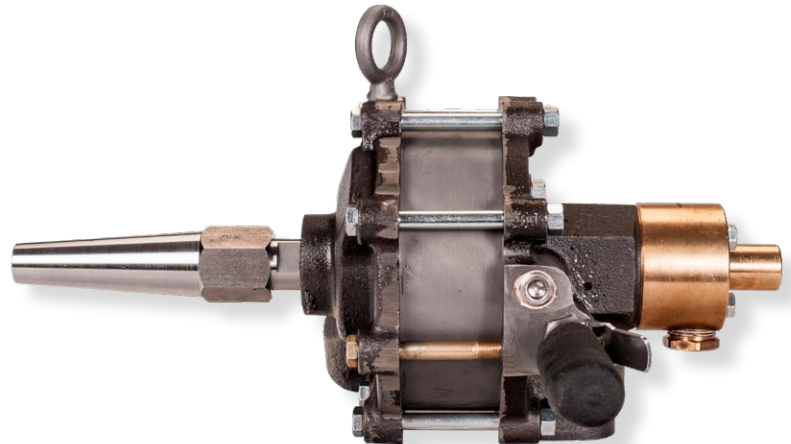
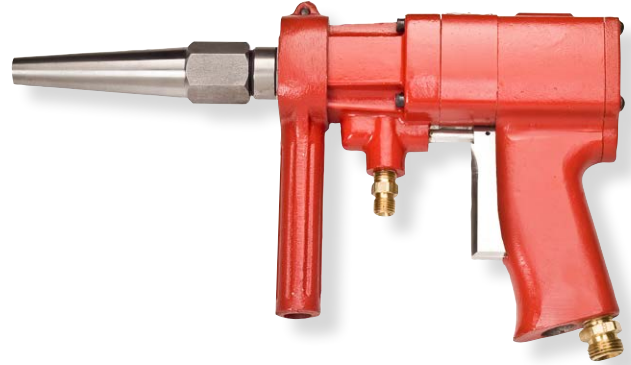

5224XL & 5125 Specifications

| Cleaner | ID Range | RPM | Air Hose Supply | Air Specifications | Water Specifications | Motor Weight |
|---------|--------------------------------------|-------|---|--|------------------------------------|----------------------|
| 5224XL | 0.305" - 1.032" (7.75 - 26.21mm) | 1,500 | 1/2" (12.7mm) Air Hose Supply | 45 CFM (1.3 M ³ /min.) @ 90 PSI (6.2 bar) | 50 PSI (3.4 bar) Water Pressure | 6 lbs. (2.72 Kg.) |
| 5125 | 0.481" - 1.902" (12.22 - 48.31mm) | 1,600 | 1" (25.0mm) Filtered Air Hose Supply | 175 CFM (5.0 M ³ /min.) @ 90 PSI (6.2 bar) | | 35 lbs. (15.9 Kg) |



5224XL & 5125 SERIES Motor Coupling

5224XL & 5125 SERIES

Motor Coupling- Connects 5224XL and 5125 Motor to Motor Shaft



Motor Coupling

Connects to the 5125 or 5224XL cleaner.



Motor Shaft

Connects Motor Coupling to the Extension Coupling.



Extension Coupling

Connects Motor Shaft to the Extension Shaft.



Extension Shaft

Extends the reach of the cleaning tool by 5' (1.5M)

Elliott Tool offers a number of shafts and couplings to be used with the 5224XL and 5125 Heat Exchanger Tube Cleaners to accommodate different tube sizes and tube lengths.

| Tube ID Range | Cleaning Shaft OD | *Motor Shaft Part # | Motor Shaft Thread Size | Motor Coupling Part # | **Extension Coupling Gasket Part # | Extension Coupling Part # | Extension Shaft Part # |
|---------------------------------------|-------------------|---------------------|-------------------------|-----------------------|------------------------------------|---------------------------|------------------------|
| 0.481" - 0.560" (12.22 - 14.22 mm) | 7/16" (11.1mm) | 5215-(FT) | 5/16-18 F | 5215C | P5034A | CS113106 | 5015-(FT) |
| 0.584" - 0.685" (14.83 - 16.56 mm) | 1/2" (12.7mm) | 5216-(FT) | 3/8-16 F | 5216C | P5034B | CS113206 | 5016-(FT) |
| 0.709" - 0.810" (18.01 - 20.57 mm) | 5/8" (15.9mm) | 5218-(FT) | | 5218C | P5034C | CS113406 | 5018-(FT) |
| 0.834" - 1.06" (21.18 - 22.91 mm) | 3/4" (19.1mm) | 5219-(FT) | 1/2-13 F | 5219C | P5034D | CS113506 | 5059-(FT) |

Note: * Specify shaft length in feet (i.e. 5213-5). ** Included with each Extension Coupling, except where noted. For Additional Lengths and Sizes Contact Customer Service.

| Tube ID Range | 5125 Series Kits | | Tube ID Range | 5224XL Series Kits | |
|---------------------------------------|------------------|-----------|---------------------------------------|--------------------|-------------|
| | Water Flush | Air Flush | | Water Flush | Air Flush |
| 0.481" - 0.56" (12.22 - 14.22 mm) | 5125-43 | 5125AP43 | 0.435" - 0.459" (11.05 - 11.66 mm) | 5224XL37 | 5224XLBMC37 |
| 0.584" - 0.685" (14.83 - 16.56 mm) | 5125-50 | 5125AP50 | 0.481" - 0.560" (12.22 - 14.22 mm) | 5224XL43 | 5224XLBMC43 |
| 0.709" - 0.81" (18.01 - 20.57 mm) | 5125-62 | 5125AP62 | 0.584" - 0.685" (14.83 - 16.56 mm) | 5224XL50 | 5224XLBMC50 |
| 0.834" - 1.06" (21.18 - 22.91 mm) | 5125-75 | 5125AP75 | 0.709" - 0.81" (18.01 - 20.57 mm) | 5224XL62 | 5224XLBMC62 |
| 1.084" - 1.902" (27.53 - 43.31 mm) | 5125-87 | 5125AP87 | 0.834" - 1.032" (21.18 - 22.91 mm) | 5224XL75 | 5224XLBMC75 |

Kit Includes: Cleaner Motor, Wrench, Hex Key, Set of Paddles, 15ft. (1.5M) Water Feed Hose, Motor Coupling, 5 ft. (1.5) Motor Shaft, (3) 5ft (1.5M) Extension Shafts, Extension Coupling, Lubricator.

Kit Includes: Cleaner Motor, Wrench, Tool Box, 5 ft. (1.5M) Motor Shaft, Motor Coupling, (3) 5ft. (1.5m) Extension Shafts, Extension Coupling, Set of Paddles, Filter/Lubricator, 7-1/2ft. (2.3M) Hose Whip.



5224XL & 5125 SERIES

Heat Exchanger Cleaner - Brushes & Drills

CT Drill
For Hard Deposits



El Paso Drill
For Soft Deposits



Drill Tip
For Gummy Deposits



Twist Drill
Carbide tipped for hard deposits



Fulfilled Brush
For Powder Deposits and Polishing



| Tube ID | | CT Drill | Thread |
|---------|------|-----------|---------|
| Inch | mm | | |
| 0.213 | 5.4 | 5029-203 | #5-40 |
| 0.306 | 7.8 | 5029-296 | #8-32 |
| 0.370 | 9.4 | 5029-359 | #10-32 |
| 0.402 | 10.2 | 5029-390 | |
| 0.435 | 11.0 | 5029-422 | 1/4-20 |
| 0.459 | 11.7 | 5029-446 | |
| 0.481 | 12.2 | 5029-446A | 5/16-18 |
| 0.495 | 12.6 | 5029-480 | |
| 0.527 | 13.4 | 5029-512 | 3/8-16 |
| 0.797 | 20.2 | 5029-787 | |
| 0.834 | 21.2 | 5029-812 | 1/2-13 |
| 0.870 | 22.1 | 5029-848 | |
| 0.902 | 22.9 | 5029-880 | 5/8-11 |
| 0.965 | 24.5 | 5029-955 | |
| 1.039 | 26.4 | 5029-1029 | 5/8-11 |
| 1.062 | 27.0 | 5029-1052 | 5/8-11 |
| 1.210 | 30.7 | 5029-1200 | 5/8-11 |
| 1.260 | 32.0 | 5029-1250 | 5/8-11 |
| 1.348 | 34.2 | 5029-1338 | 5/8-11 |
| 1.380 | 35.1 | 5029-1370 | 5/8-11 |

| Tube ID | | El Paso Drill | Thread |
|---------|------|---------------|---------|
| Inch | mm | | |
| 0.306 | 7.8 | 5005-296 | #8-32 |
| 0.338 | 8.6 | 5005-328 | |
| 0.370 | 9.4 | 5005-359 | #10-32 |
| 0.402 | 10.2 | 5005-390 | |
| 0.435 | 11.0 | 5005-422 | 1/4-20 |
| 0.478 | 12.1 | 5005-468 | 5/16-18 |
| 0.495 | 12.6 | 5005-480 | |
| 0.527 | 13.4 | 5005-512 | 1/2-13 |
| 0.555 | 14.1 | 5005-544 | |
| 0.834 | 21.2 | 5005-812 | 5/8-11 |
| 0.870 | 22.1 | 5005-848 | |
| 0.902 | 22.9 | 5005-880 | 5/8-11 |
| 0.965 | 24.5 | 5005-955 | |
| 1.062 | 27.0 | 5005-1052 | 5/8-11 |
| 1.215 | 30.9 | 5005-1200 | |
| 1.290 | 32.8 | 5005-1280 | 5/8-11 |
| 1.356 | 34.4 | 5005-1338 | |
| 1.384 | 35.2 | 5005-1370 | 5/8-11 |
| 1.478 | 37.5 | 5005-1468 | |
| 1.510 | 38.4 | 5005-1492 | 5/8-11 |
| 1.584 | 40.2 | 5005-1562 | |

| Tube ID | | Twist Drill | Thread |
|---------|-------|-------------|---------|
| Inch | mm | | |
| 0.291 | 7.4 | 5172-281 | #10-32 |
| 0.435 | 11.0 | 5172-426 | 1/4-20 |
| 0.481 | 12.2 | 5172-475 | 5/16-18 |
| 0.532 | 13.5 | 5172-507 | |
| 0.584 | 14.83 | 5172-564 | 3/8-16 |
| 0.620 | 15.75 | 5172-600 | |
| 0.652 | 16.56 | 5172-632 | 1/2-13 |
| 0.709 | 18.01 | 5172-689 | |
| 0.745 | 18.92 | 5172-725 | 1/2-13 |
| 0.777 | 19.74 | 5172-757 | |
| 0.834 | 21.2 | 5172-814 | 1/2-13 |
| 0.870 | 22.1 | 5172-850 | |
| 0.902 | 22.9 | 5172-882 | 1/2-13 |

| Tube ID | | Drill Tip | Thread |
|---------|------|-----------|---------|
| Inch | mm | | |
| 0.435 | 11.0 | 5100-422 | 1/4-20 |
| 0.481 | 12.2 | 5100-468 | 5/16-18 |
| 0.495 | 12.6 | 5100-480 | |
| 0.527 | 13.4 | 5100-512 | 5/16-18 |
| 0.560 | 14.2 | 5100-544 | |
| 0.810 | 20.6 | 5100-790 | 1/2-13 |
| 0.834 | 21.2 | 5100-812 | |
| 0.870 | 22.1 | 5100-848 | 1/2-13 |
| 0.902 | 22.9 | 5100-880 | |

| Tube ID | | Fulfilled Brush | Thread |
|---------|------|-----------------|---------|
| Inch | mm | | |
| 0.459 | 11.7 | 5226B28 | 1/4-20 |
| 0.481 | 12.2 | 5226C28 | 5/16-18 |
| 0.495 | 12.6 | 5226C30 | |
| 0.527 | 13.4 | 5226C32 | 5/16-18 |
| 0.560 | 14.2 | 5226C34 | |
| 0.810 | 20.6 | 5226D50 | 3/8-16 |
| 0.834 | 21.2 | 5226E52 | 1/2-13 |
| 0.870 | 22.1 | 5226E54 | |
| 0.902 | 22.9 | 5226E56 | 1/2-13 |



5224XL & 5125 SERIES

ARE YOU GETTING THE MOST OUT OF YOUR TUBE TOOLS?

Expert knowledge, real-world applications, and tooling updates.
Delivered straight to your inbox.



Elliott's Tube Tool Newsletter is written for maintenance professionals, engineers, and contractors who want **practical information** they can use on the job. Each issue focuses on real challenges backed by Elliott's decades of application experience.

No spam. No fluff. Just proven solutions and best practices.



Stay informed. Stay competitive.
Scan the QR code to subscribe today.

ROTO-JET

Rotary Tube Cleaning Systems

Tube Size

- 0.250" to 3.000" ID
- 6.35 to 76.2mm ID

Tube Section

- Straight
- Curved

Type

- Soft, gummy or organic

Thickness

- Light
- Medium

Flush

- Wet
- Dry

Elliott Tool Roto-Jet Cleaning Systems are an effective solution to increasing chiller, condenser, and other heat exchanger efficiency.

Elliott Tool offers a variety of Roto-Jet Tube Cleaners to suit your specific application needs:

Roto-Jet I Series

Electric heavy duty models 0620AR (110V) and 0820AR (220V) are ideal for mechanical contractors that perform tube cleaning on a regular basis. Equipped with a 1 HP motor, these cleaners are powerful yet simple to use due to their reversing capability.

Pneumatic Roto-Jet

Model 0420 is a pneumatic tube cleaner with a powerful 4 HP motor to clean tubes where electricity is not readily available. The 0420 is perfect for tube cleaning performed in power utility plants and paper, steel, and sugar mills.

All of the Roto-Jet Tube Cleaning Systems use flexible shafts and cleaning tools to flush deposits free from the tubes, enabling you to increase heat transfer efficiencies while reducing your heat transfer costs.



Features & Benefits:

- Heavy duty shaft for cleaning heavy deposits.
- Flexible shaft with water flush for removal of deposits in curved tubes.
- Storage compartment for foot pedal, controls, & supplies.
- Lightweight and sized for confined work spaces.
- Uses standard flex shafts for easy maintenance.
- Ground fault isolation for increased operator safety.
- Roto-Jet II (220V) is CE mark certified.

| Part # | Voltage | Reversible | RPM | Dimensions | | Weight | | Tube ID | |
|--------|------------------|------------|--------|---------------------|-----------------|--------|-----|-------------|-----------|
| | | | | Inch | mm | lbs. | Kg. | Inch | mm |
| 0620AR | 110 | Yes | 850 | 17 X 15 X 10.5 | 432 X 381 X 267 | 63 | 29 | 0.250-3.000 | 6.35-76.2 |
| 0820AR | 220 | Yes | 850 | 17 X 15 X 10.5 | 432 X 381 X 267 | 63 | 29 | 0.250-3.000 | 6.35-76.2 |
| 0650R | 110 | Yes | 0-1800 | 11 X 20 X 9 | 280 X 508 X 229 | 35 | 16 | 0.250-1.000 | 6.35-25.4 |
| 0750R | 220 | Yes | 0-1800 | 11 X 20 X 9 | 280 X 508 X 229 | 35 | 16 | 0.250-1.000 | 6.35-25.4 |
| Part # | Air Requirement | Reversible | RPM | Dimensions | | Weight | | Tube ID | |
| | | | | Inch | mm | lbs. | Kg. | Inch | mm |
| 0420 | 138 CFM @100 PSI | No | 0-2500 | 21.5 X 10.25 X 10.5 | 546 X 261 X 267 | 48 | 22 | 0.250-3.000 | 6.35-76.2 |



Moisture Application Notes

- Wet:** Commonly used in chillers, watertube boilers, and other applications where water does not inhibit cleaning. Never operate wet shafts without water flushing through the shaft's casing.
- Dry:** Commonly used in firetube boilers and sugar mill cleaning.



Flexible Wet Shaft



Flexible Dry Shaft

| Wet Shaft | | | | | | | | | | | | | | | | |
|-------------|-------------|---------------------------------|------|---------|------|---------|------|---------|------|---------------------|----|----------------|---------------------|----------------|---------------|-----------------------------|
| Tube ID | | Flexible Shaft Part #'s Lengths | | | | | | | | Shaft Case Diameter | | Drive Coupling | Break-Away Coupling | Solid Coupling | Tool Coupling | Female Tool Coupling Thread |
| Inch | mm | Ft | Mtrs | Ft | Mtrs | Ft | Mtrs | Ft | Mtrs | Inch | mm | | | | | |
| | | 15 | 4.5 | 25 | 7.6 | 35 | 10.7 | 50 | 15.2 | | | | | | | |
| 0.250-0.375 | 6.99-9.53 | 051115 | | 051125 | | 051135 | | 051150 | | 0.250 | 6 | 0516 | | | 0513 | #8-32 |
| 0.437-0.500 | 11.10-12.70 | 051215 | | 051225 | | 051235 | | 051250 | | 0.375 | 10 | 0503 | 0501 | 0502 | 0504 | 1/4"-28 |
| 0.562-1.000 | 14.27-25.40 | 051315 | | 051325 | | 051335 | | 051350 | | 0.500 | 13 | 0506 | | | 0507 | |
| 0.750-1.500 | 19.05-38.10 | 0514A15 | | 0514A25 | | 0514A35 | | 0514A50 | | 0.625 | 16 | 0514-3 | | | 0514-1 | |
| 1.000-2.000 | 25.40-50.80 | 051415 | | 051425 | | 051435 | | 051450 | | 0.750 | 19 | 0508 | | | 0509 | 1/2" WHIT |
| 2.000+ | 50.80+ | 051515 | | 051525 | | 051535 | | 051550 | | 1.000 | 25 | 0510 | | | 0511 | |
| Dry Shaft | | | | | | | | | | | | | | | | |
| 1.000+ | 25.40-50.80 | 053415 | | 053425 | | 053435 | | 053450 | | | | 0508 | | | 0509 | 1/2" WHIT |

Spares & Accessories:

- Break-Away Coupling: 0501-10
- Solid Coupling: 0502-10
- Drive Coupling
- Tool Coupling
- 901717P Filter/Lubricator (Pneumatic)
- Flexible Shaft Repair Kit Includes 3 Coupling Adapters, 3 Tool Couplings, Brass Coupling, 3 Shaft Washers, 1 Male Connector, 3 O Rings, Crimping Block (on K1 kits only).
- Adapters are available upon request.

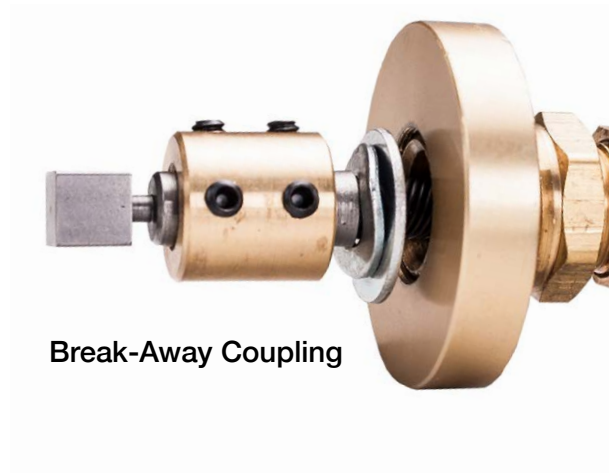

Break-Away Coupling



ROTO-JET Brushes

ROTO-JET



0942 Stainless

Deposit: Light Scale
Tube: Non-Ferrous, Prime
Flush: Wet



0942B Brass

Deposit: Light Scale
Tube: Non-Ferrous, Prime
Flush: Wet



5508 Turbo

Deposit: Light Scale
Tube: Non-Ferrous & Ferrous, Enhanced
Flush: Wet



5510 Turbo

Deposit: Light Scale
Tube: Non-Ferrous & Ferrous Prime
Flush: Wet



0954 Flex Hones

Deposit: Light Scale
Tube: Ferrous, Prime
Flush: Wet



HD Nylon

Deposit: Medium to Heavy Mud
Tube: Non-Ferrous & Ferrous, Prime
Flush: Wet



5513 Turbo

Deposit: Light to Medium Scale
Tube: Non-Ferrous & Ferrous, Prime
Flush: Wet



0904 Steel Wire

Deposit: Light (Soot) Scale
Tube: Ferrous, Prime
Cleaning Type: Dry

| Tube ID | | Shaft Size | 0942 Stainless | 0942B Brass | 5508 Turbo | 5510 Turbo | 0954 Flex Hone | 5502 HD Nylon | 5513 Turbo |
|---------------|---------------|------------|----------------|-------------|------------|------------|----------------|---------------|------------|
| Inch | mm | | | | | | | | |
| 0.180 - 0.250 | 4.57 - 6.35 | - | 0942250 | 0942B250 | | | | 5502-250 | |
| 0.250 - 0.312 | 6.35 - 7.92 | 0511 | 0942312 | 0942B312 | | | | 5502-312 | |
| 0.312 - 0.375 | 7.92 - 9.53 | | 0942375 | 0942B375 | | | | 5502-375 | |
| 0.375 - 0.437 | 9.53 - 11.10 | | 0942437 | 0942B437 | | | 0954-437 | 5502-437 | |
| 0.437 - 0.500 | 11.10 - 12.70 | 0512 | 0942500 | 0942B500 | | 5510-8* | 0954-500 | 5502-500 | |
| 0.500 - 0.562 | 12.70 - 14.27 | | 0942562 | 0942B562 | | | 0954-562 | 5502-562 | |
| 0.562 - 0.625 | 14.27 - 15.88 | 0513 | 0942625 | 0942B625 | 5508-12 | | 0954-625 | 5502-625 | |
| 0.625 - 0.687 | 15.88 - 17.45 | | 0942687 | 0942B687 | | | 0954-687 | 5502-687 | |
| 0.687 - 0.750 | 17.45 - 19.05 | | 0942750 | 0942B750 | | 5510-12** | 0954-750 | 5502-750 | |
| 0.750 - 0.812 | 19.05 - 20.62 | | 0942812 | 0942B812 | | | | 5502-812 | |
| 0.875 | 22.22 | 0514A | 0942875 | 0942B875 | 5508-16 | | 0954-875 | 5502-875 | |
| 0.937 | 23.80 | | 0942937 | 0942B937 | | | | 5502-937 | |
| 1.000 | 25.40 | | 09421000 | 0942B1000 | 5508-18 | 5510-16 | 0954-1000 | 5502-1000 | |
| 1.062 | 26.97 | | 09421062 | 0942B1062 | | | | | |
| 1.125 | 28.58 | 0515 | 09421125 | 0942B1125 | | 5510-18 | | | |
| 1.187 | 30.15 | | 09421187 | 0942B1187 | | | | | |
| 1.250 | 31.75 | | 09421250 | 0942B1250 | | 5510-20 | | | |
| 1.312 | 33.32 | | 09421312 | 0942B1312 | | | | | |
| 1.437 | 36.50 | | 09421437 | 0942B1437 | | | | | |
| 1.500 | 38.10 | | 09421500 | 0942B1500 | | | | | 5513-24*** |
| 1.750 | 44.45 | | | | | | | | 5513-28 |
| 2.000 | 50.80 | | | | | | | | 5513-32 |

*Use 0511 shaft with 5510-8 brush

**Use 0512 shaft with 5510-12 brush

***Use 0515 shaft with 5513-24 brush

| Tube ID | | Shaft Size | 0904 Steel Wire |
|-------------|-------------|------------|-----------------|
| Inch | mm | | |
| 0.687-0.750 | 17.45-19.05 | 0534 | 0904750 |
| 1.000 | 25.40 | | 09041000 |
| 1.250 | 31.75 | | 09041250 |
| 1.500 | 38.10 | | 09041500 |
| 1.750 | 44.45 | | 09041750 |
| 2.000 | 50.80 | | 09042000 |
| 2.250 | 57.15 | | 09042250 |
| 2.500 | 63.50 | | 09042500 |
| 2.750 | 69.85 | | 09042750 |
| 3.000 | 76.20 | | 09043000 |
| 3.250 | 82.55 | | 09043250 |
| 3.500 | 88.90 | | 09043500 |
| 3.750 | 95.25 | | 09043750 |
| 4.000 | 101.60 | | 09044000 |
| 4.500 | 114.30 | | 09044500 |
| 5.000 | 127.00 | | 09045000 |
| 5.500 | 139.70 | 09045500 | |
| 6.000 | 152.40 | 09046000 | |

| Tube ID | | Descaling Tool | Descaling Tool w/ Drill Tip | Blade Refills | Shaft Size |
|-------------|-------------|----------------|-----------------------------|---------------|------------|
| Inch | mm | | | | |
| 0.312-0.375 | 7.92-9.53 | 09461* | 09471* | 0946RF2 | 0511 |
| 0.375-0.500 | 9.53-12.70 | 09462 | 09472 | 0946RF2 | 0512 |
| 0.500-0.625 | 12.70-15.88 | 09463 | 09473 | 0946RF3 | 0513 |
| 0.625-1.000 | 15.88-25.40 | 09464 | 09474 | 0946RF4 | 0514A |
| 1.000-3.000 | 25.40-76.20 | 09465 | 09475 | 0946RF5 | 0514 |

*Requires adapter 5100AC (included with 0511 shafts).

Ferrous materials include: steels, titanium, hastelloy. Non-Ferrous materials include: copper, brass, bronze, aluminum.



0946 Descal No Drill

Deposit: Medium Scale
Tube: Ferrous, Prime
Flush: Wet or Dry



0947 Descal With Drill

Deposit: Medium Scale
Tube: Ferrous, Prime
Flush: Wet



| Vacuums and Accessories | | Part # | Description |
|-------------------------|---|-----------|---|
| Vacuums |  | 08520 | 110V/60 Hz, 115 CFM for dry or wet service 20 gallon capacity, 13 AMPS, 2 HP, 08522 10' suction hose included |
| | | 08520-220 | 220V/50 Hz, 115 CFM for dry or wet service 20 gallon capacity, 7 AMPS, 2 HP, 08522 10' suction hose included |
| | | 08509 | Cloth Filter Bag |
| | | 08510 | Paper Filter Bag (3 per pkg.) |
| | | 08511 | Canvas Filter Bag |
| Suction Adapter |  | 08540 | 10 feet (3M) long Diameter: 2" (50.8mm) includes 2" Hose to 1-1/2" Tool Cuff |
| | | 08542 | 25 feet (7.6M) long Diameter: 2" (50.8mm) includes 2" Hose to 1-1/2" Tool Cuff |
| Nozzles |  | 08537 | 5" (127mm) Dusting Brush |
| |  | 08539 | 6" (152.4mm) Aluminum Utility Tool |
| |  | 08529 | 2" (50.8mm) "Y" Adapter |



CHALLENGES OF MARINE CHILLER & HEAT EXCHANGER MAINTENANCE

Optimizing the performance of marine chillers and heat exchangers presents a unique set of challenges for maintenance managers. Unlike their land-based counterparts, these critical components operate in a harsh, unpredictable environment that demands specialized maintenance strategies. Understanding these challenges is key to preventing costly downtime and ensuring reliable operations at sea.

THE MOST SIGNIFICANT HURDLE is the corrosive nature of saltwater. While it's the only practical cooling medium in marine applications, saltwater is a large contributor of accelerated fouling and scaling. This is compounded by the ever-present threat of galvanic corrosion, which can occur if dissimilar metals are inadvertently used in the system, particularly with components like tube plugs. Specialized materials are often required to mitigate this reaction and prevent degradation.

Biofouling is another pervasive issue in marine environments. Warm seawater provides an ideal habitat for marine organisms like algae, barnacles, and mussels, which readily attach to heat exchanger tubes. These biological deposits create a tough layer that significantly impedes heat transfer and can be incredibly difficult to remove, often requiring specialized cleaning techniques.

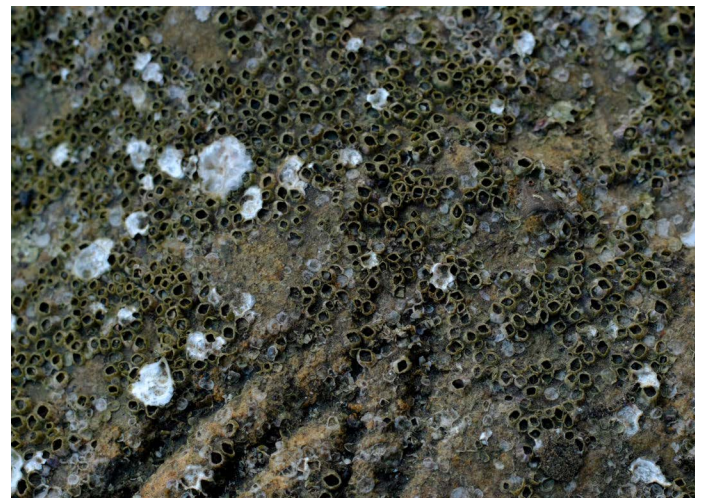

Barnacle Accumulation of Marine Surface



Adding to these material and biological challenges is accessibility. Offshore rigs, submersibles, platforms, and ships are inherently space-constrained environments. This limited access can make routine maintenance and emergency repairs of chillers and heat exchangers extremely difficult. In some cases, units may even need to be brought into a dock for comprehensive maintenance if in-place cleaning isn't feasible, leading to significant logistical complexities and potential operational interruptions.

Furthermore, water quality variation introduces an element of unpredictability. The composition of seawater can vary dramatically depending on location, whether in a harbor, open ocean, or polluted waters. These variables can lead to different wear patterns and rates of fouling, making it impossible to apply a one-size-fits-all approach to maintenance. This necessitates a flexible and adaptive maintenance strategy tailored to the specific operating environment of each unit.

The stakes are particularly high when a marine chiller or heat exchanger fails mid-sea. Such a failure can directly impact critical process streams, whether it's refrigeration for food, heating for essential systems, or other vital functions. Depending on the application, an emergency service intervention might be urgently required, incurring significant costs and operational disruptions.

To combat these challenges, maintenance strategies often involve a combination of techniques. For instance, rotary cleaners with a dry flush are often preferred for breaking up deposits due to space constraints. If a vessel is being moved or taken offline, chemical cleaning can be initiated to loosen deposits, followed by mechanical cleaning as a secondary operation.

Additionally, the implementation of strainers or filters can help reduce the occurrence and rate of fouling, though these require routine checks to ensure their effectiveness.

In conclusion, maintaining marine chillers and heat exchangers pose many unique challenges and demand a proactive approach. Maintenance managers must recognize the unique pressures of the marine environment and implement strategies to mitigate the effects of corrosion, biofouling, and water variation to ensure continuous and efficient operations.



Tube Sheet Fouling

DIE-HARD™

Cableless Tube Cleaner

Tube Size

- 3/4" and 1" OD
- 19.1mm and 25.4mm OD

Tube Section

- Straight

Type

- Soft, gummy or organic

Thickness

- Light
- Medium

Flush

- Wet

CLEANS BETTER IN LESS TIME.

Elliott Tool's Die-Hard™ is the first cableless tube cleaner that successfully cleans light to medium deposits found in chiller, condenser, and heat exchanger tubes.

Water pressure is utilized instead of a spinning cable to provide the power for the brushing action. A patented pulse-jet actuator with brush provides a quad cleaning action to flush tube debris such as scale, mud, and algae out the back end of the tube. The Die-Hard™'s quad cleaning action enables you to be more productive while getting tubes cleaner!

Features & Benefits:

- Cleans better in less time.
- No cable! That's right - never spend time or money on replacement flex shafts or cables again.
- Rugged engineering and construction for higher uptime and lower repair costs.
- Three feet/second auto feed for high productivity.
- Ergonomic design for lower labor costs and higher operator satisfaction.
- Quad cleaning action for better cleaning and productivity.
- Drain port design prevents the actuator from being pulled into the system and damaging gears.

Specifications:

- 110/1/60 electric, 14 amps
- 0.5 GPM water consumption
- 10 pulses / second ~ 800 PSI
- Hydro powered brush actuator



M5801-00 Die-Hard™ Cleaner Package includes:

- M5801-21 Auto-Feed Pump Unit
- M5801-02-45 45 ft. (13.7M) Auto-Feed Hose
- M5801-03T Trigger Switch Feed Gun Assembly (includes M5808-20 Trigger Switch Feed Gun, M5801-03-03 Auto-feed Casing, and M5801-03-01 3/4" (19.1mm) and M5801-03-02 1" (25.4mm) Gun Nozzles)
- M5801-04 Actuator (0.520" OD)
- M5803-02 Antifreeze w/ Adapter
- (2) M5801-09 3/8-7/16 Combination Wrenches
- M5801-11 Mesh Bag
- Brushes sold separately.



Visit Our YouTube Channel To
See the Die-Hard in action!

www.youtube.com/elliott-tool





M5801-10 Rocker
Style Footswitch



M5807-00 Detachable
Contractor Dolly



M5803-00 Spares Kit



M5803-02 Antifreeze
with Adapter

Spares & Accessories:

- Detachable Contractor Dolly: M5807-00
- Spares Kit (M5803-00) Includes: A toolbox, five nylon brushes of 20 different sizes for 3/4" and 1" tubes, and a 0.5 gallon of antifreeze with an adapter (M5803-02). For 7/8" applications Elliott offers the M5803-00-875 Spare Brush Kit that includes five nylon brushes of five different sizes.
- Tool Box Expansion Tray: M5803-01-02
- Antifreeze with Adapter: M5803-02
- Trigger Switch Feed Gun: M5808-20
- Actuator: M5801-04
- Feed Hose: Available in 35 ft (M5801-02-35) and 45 ft (M5801-02-45). Other sizes available.
- Auto-feed Casing: M5801-03-03
- Gun Nozzle: Available in 3/4" (19.1mm) M5801-03-01, 7/8" (22.23mm) M5801-03-09 and 1" (25.4mm) M5801-03-02.
- Tube Hole Gauge: 3/4" (19.1mm) 876200-750 and 1" (25.4mm) 876200-1000.
- M5801-04-05 Spring for Actuator



| | | Brushes | | |
|-------------|-------------|----------------|--------------|------------|
| Tube ID | | Brush Diameter | Part # | |
| Inch | mm | | Single Brush | 25 Pack |
| 0.530-0.544 | 13.46-13.82 | 0.530 | 5535-530 | 5535-530PK |
| 0.545-0.559 | 13.84-14.20 | 0.545 | 5535-545 | 5535-545PK |
| 0.560-0.572 | 14.22-14.53 | 0.560 | 5535-560 | 5535-560PK |
| 0.573-0.589 | 14.55-14.96 | 0.573 | 5535-573 | 5535-573PK |
| 0.590-0.607 | 14.99-15.42 | 0.590 | 5535-590 | 5535-590PK |
| 0.608-0.624 | 15.44-15.85 | 0.608 | 5535-608 | 5535-608PK |
| 0.625-0.637 | 15.88-16.18 | 0.625 | 5535-625 | 5535-625PK |
| 0.638-0.651 | 16.21-16.54 | 0.638 | 5535-638 | 5535-638PK |
| 0.652-0.665 | 16.56-16.89 | 0.652 | 5535-652 | 5535-652PK |
| 0.666-0.679 | 16.92-17.25 | 0.666 | 5535-666 | 5535-666PK |
| 0.680-0.694 | 17.27-17.63 | 0.680 | 5535-680 | 5535-680PK |
| 0.695-0.709 | 17.65-18.01 | 0.695 | 5535-695 | 5535-695PK |
| 0.740-0.754 | 18.80-19.15 | 0.740 | 5535-740 | 5535-740PK |
| 0.755-0.769 | 19.18-19.53 | 0.755 | 5535-755 | 5535-755PK |
| 0.770-0.784 | 19.56-19.91 | 0.770 | 5535-770 | 5535-770PK |
| 0.785-0.799 | 19.94-20.29 | 0.785 | 5535-785 | 5535-785PK |
| 0.800-0.819 | 20.32-20.80 | 0.800 | 5535-800 | 5535-800PK |
| 0.820-0.839 | 20.83-21.31 | 0.820 | 5535-820 | 5535-820PK |
| 0.840-0.859 | 21.34-21.82 | 0.840 | 5535-840 | 5535-840PK |
| 0.860-0.879 | 21.84-22.33 | 0.860 | 5535-860 | 5535-860PK |
| 0.880-0.899 | 22.35-22.83 | 0.880 | 5535-880 | 5535-880PK |
| 0.900-0.915 | 22.86-23.24 | 0.900 | 5535-900 | 5535-900PK |
| 0.916-0.932 | 23.27-23.67 | 0.916 | 5535-916 | 5535-916PK |
| 0.933-0.943 | 23.70-23.95 | 0.933 | 5535-933 | 5535-933PK |
| 0.944-0.956 | 23.98-24.28 | 0.944 | 5535-944 | 5535-944PK |

Note: Do not use other brushes with your Die-Hard™ Cleaner.



UNIVERSITY OF TEXAS AT AUSTIN CHOOSES THE

DIE HARD AS THEIR PREFERRED CLEANING MACHINE



QUICK SUMMARY

The Challenge

- Every time they used their previous machine, something broke.
- Passing the annual bore scope inspections was becoming a challenge.

The Solution

- Tried Elliott's Die-Hard tube cleaning system during their year round cleaning season.
- Die-Hard offered a cableless design eliminating the need to replace cables.
- Quad cleaning brush action powered by water pressure and pulse-jet actuator.

The Results

- Dependable cleaning machines and hoses last the whole season.
- Brush with actuator does a better job cleaning tubes.
- Elliott's service has always been reliable and parts are available.
- Improved productivity.

The Challenge

The Chilling Station Maintenance Supervisor, Charles Gardinier and the operators who work with him at the University of Texas at Austin are faced with the challenge of keeping several 5,000-ton chillers in peak operating condition. Part of their maintenance is cleaning the vessels to maintain high efficiency.

However, they were experiencing daily challenges with their previous machines breaking down every time they were used. According to Charles, the spinning cable tended to be the worst problem. Either the spring of the cable would break or the cable would kink, which would cost about \$400 each time in parts and labor.

The operators also like to use a tighter brush and brush hard due to scale buildup. Getting a good clean on their chillers with their previous cleaning system was becoming a very difficult job.

Charles was looking for a reliable tube cleaner with brushes to handle their application that would enable his operators to efficiently clean tubes.

The Solution

The technicians used Elliott's Die-Hard during a year-round cleaning season. The Die-Hard is a cableless tube cleaning system designed for light to medium deposits found in chiller, condenser and heat exchanger tubes.

Instead of using a rotating cable with a spinning brush, the Die-Hard utilizes water pressure to power the brushing action. This eliminated Charles' need to constantly replace broken cables.

A pulse-jet actuator enables the brush to provide a quad cleaning action that quickly flushes tube debris such as scale, algae, and mud out of the tube.

The Results

"Operators like the tool a lot," says Charles.

They immediately appreciated:

- Rugged engineering and construction of the Die-Hard and its brushes for a better

clean, higher uptime, lower repair costs.

- Automatic feeding unit: Roughly the same automatic feeding speed as his older unit.

- No broken cables and very minimal maintenance required for Elliott's Die-Hard.

"All we do is replace the consumable items due to wear and tear and the ruggedness and dependability of Elliott machines and hoses mean they last the whole, annual season," said Charles. This means the University avoids the approximate \$400 cost in parts and labor that would inevitably happen with each use of their previous machines.

The Elliott system is "much more reliable than our previous supplier's and the Die-Hard's brush with actuator does a lot better job cleaning our tubes."

On top of the improvements in uptime and the more efficient cleaning of tubes with the Die-Hard, "Elliott's service has always been good and reliable and replacement parts and consumables are available if we need them," said Charles.

Charles is very pleased with his Die-Hard Tube Cleaner and the time and money that he has saved his operators and the University of Texas at Austin.

“

The Elliott system is much more reliable than our previous supplier's and the Die-Hard's brush with actuator does a lot better job cleaning our tubes.

Charles Gardinier
Chilling Station
Maintenance
Supervisor



SOOT BUSTER

Firetube Boiler Tube Cleaning System

Tube Size

- 1-1/4" to 4" OD
- 31.8 to 101.6mm OD

Tube Section

- Straight

Type

- Soft (Soot)

Thickness

- Light
- Medium

Flush

- Dry

WEIGHS ONLY 3 LBS

Lightweight Design Reduces Operator Fatigue.

Elliott's Soot Buster is a pneumatically actuated cleaning tool used to clean firetube boilers.

Simply insert the brush into the tube and the unique oscillating action will propel the cleaner at 1.5 feet per second, scrubbing the tube ID with each pulse. When it senses the end of the tube, the cleaner reverses the direction of thrust and returns to the operator.

With a capability of cleaning 60 tubes per hour, the time required to clean a firetube boiler or oil field drill pipe is greatly reduced.

Features & Benefits:

Lightweight (3.5 lbs)

Compact design reduces operator fatigue, increasing productivity.

Decrease Downtime

Rugged construction with no plastic gears or parts for long lasting cleaning action.

Air Powered

The operator stays completely dry.

Quick & Easy Setup

Set-up is fast with no cables to arrange. Just select the proper brush size and start cleaning!

Half The Time As Rotary Cleaners

Auto-feed is a standard feature, allowing the brush to self-feed to the end of the tube. When it senses the end of the tube, it reverses direction, eliminating the need to "measure-off."



Soot Buster package includes:

- Pneumatic air pulsator motor
- Pneumatic foot control valve
- Filter/lubricator with pressure gauge
- Y-tube for vacuum hose
- 33 ft. (10M) air source hose
- 33 ft. (10M) heavy-duty pulsator motor hose
- 16-1/2 ft. (5M) filter/lubricator air hose

“ The Soot Buster not only makes my job so much easier, but it is really a dream come true. I'm so happy we bought it.

Joe Stewart

Great Smoky Mountains Railroad



SOOT BUSTER

Firetube Boiler Tube Cleaning System

SOOT BUSTER

| Tube OD | BWG | ID Range | Brush OD | Brush Part Number | Soot Buster Package | Air Requirement |
|--------------------|-------|-----------------|-----------------|-------------------|---------------------|----------------------------------|
| 1-1/4" (31.8mm) | 13-16 | 1.060" - 1.120" | 1-1/8" (28.6mm) | 26B10 | M5784-01 | 13-15 cfm* 80 psi (5.5 bar)** |
| | 19-26 | 1.166" - 1.214" | 1-1/4" (31.8mm) | 26B11 | | |
| 1-1/2" (38.1mm) | 13-16 | 1.310" - 1.370" | 1-3/8" (34.9mm) | 26B12 | M5784-02 | 16-20 cfm* 100 psi (7 bar)** |
| | 19-26 | 1.416" - 1.464" | 1-1/2" (38.1mm) | 26B13 | | |
| 1-3/4" (44.5mm) | 13-16 | 1.560" - 1.620" | 1-5/8" (41.3mm) | 26B14 | M5784-00 | 23-25 cfm* 100 psi (7 bar)** |
| | 19-26 | 1.666" - 1.714" | 1-3/4" (44.5mm) | 26B15 | | |
| 2" (50.8mm) | 10-14 | 1.760" - 1.834" | 1-7/8" (47.6mm) | 26B16 | M5784-03 | 25-28 cfm* 80 psi (5.5 bar)** |
| | 15-26 | 1.856" - 1.964" | 2" (50.8mm) | 26B17 | | |
| 2-1/4" (57.2mm) | 7-14 | 1.890" - 2.084" | 2-1/8" (53.9mm) | 26B18 | M5784-03 | 25-28 cfm* 80 psi (5.5 bar)** |
| | 15-26 | 2.106" - 2.214" | 2-1/4" (57.2mm) | 26B19 | | |
| 2-1/2" (63.6mm) | 7-14 | 2.140" - 2.334" | 2-3/8" (60.4mm) | 26B20 | M5784-03 | 25-28 cfm* 80 psi (5.5 bar)** |
| | 15-26 | 2.356" - 2.464" | 2-1/2" (63.5mm) | 26B21 | | |
| 2-3/4" (70.0mm) | 7-14 | 2.390" - 2.584" | 2-5/8" (66.8mm) | 26B22 | M5784-03 | 25-28 cfm* 80 psi (5.5 bar)** |
| | 15-26 | 2.606" - 2.714" | 2-3/4" (69.9mm) | 26B23 | | |
| 3" (76.3mm) | 7-14 | 2.640" - 2.834" | 2-7/8" (73.0mm) | 26B24 | M5784-03 | 25-28 cfm* 80 psi (5.5 bar)** |
| | 15-26 | 2.856" - 2.964" | 3" (76.2mm) | 26B25 | | |
| 3-1/4" (82.6mm) | 7-14 | 2.890" - 3.084" | 3-1/8" (79.4mm) | 26B26 | M5784-03 | 25-28 cfm* 80 psi (5.5 bar)** |
| | 15-26 | 3.106" - 3.214" | 3-1/4" (82.6mm) | 26B27 | | |
| 3-1/2" (88.9mm) | 7-14 | 3.140" - 3.334" | 3-3/8" (85.7mm) | 26B28 | M5784-03 | 25-28 cfm* 80 psi (5.5 bar)** |
| | 15-26 | 3.356" - 3.464" | 3-1/2" (88.9mm) | 26B29 | | |
| 3-3/4" (95.3mm) | 7-14 | 3.390" - 3.584" | 3-5/8" (92.1mm) | 26B30 | M5784-03 | 25-28 cfm* 80 psi (5.5 bar)** |
| 4" (101.6mm) | 15-26 | 3.856" - 3.964" | 4" (101.6mm) | 26B33 | | |

* Actual volume required- not the cfm stated on the compressor.
 ** +/- 5%

| Spares & Accessories* | Part # | Description |
|-----------------------|-----------|---|
| Vacuums | 08520 | 110V/60 Hz, 115 CFM for dry or wet service 20 gallon capacity, 13 AMPS, 2 HP, 08522 10' suction hose included |
| | 08520-220 | 220V/50 Hz, 115 CFM for dry or wet service 20 gallon capacity, 7 AMPS, 2 HP, 08522 10' suction hose included |
| | 08510 | Paper Filter Bag (3 per pkg.) |
| | 08509 | Cloth Filter Bag |
| | 08511 | Canvas Filter Bag |
| Suction Hoses | 08540 | 10 feet (3.0M) long- 2" (50.8mm) Diameter: 2" (50.8mm) includes 2" Hose to 1-1/2" Tool Cuff |
| | 08542 | 25 feet (7.6M) long- 2" (50.8mm) Diameter: 2" (50.8mm) includes 2" Hose to 1-1/2" Tool Cuff |

* Not available for rent



A SUPERIOR & PRODUCTIVE WAY TO CLEAN BOILER TUBES



QUICK SUMMARY

The Challenge

- Minimize downtime while keeping a tight maintenance schedule.
- Cable cleaners required too much time to set-up and were difficult to use in tight spaces.
- High consumable cost replacing broken cables.

The Solution

- Tried Elliott's Soot Buster on an upcoming maintenance job cleaning 680 tubes.

The Results

- Less than 1/2 the time for maintenance.
- Less consumable costs.
- Worked well in tight spaces.

The Challenge

With a very tight schedule and the demands for minimal down time, Chris Lewis, Maintenance Manager at Neath Port Talbot Ltd, needed to find a way to clean his two Cochran Boilers. On a limited budget and with 340 tubes in each boiler, he needed to find a quick and efficient tube cleaning method.

There are many tube cleaning methods – water, electric, or air. After using electric rotary tools for a short period of time, he was disappointed with the results. The expensive cables broke regularly and the tool damaged tubes and tube ends. Chris was looking for a fast, but efficient, air operated tool. Water was not an option because of the effluent problems and resulting mess. He needed to overcome the following major problems he was experiencing:

- Too much set-up time in laying out the cables.
- Cleaning in tight spaces.
- Major consumable costs each year with the constant replacement of cables.
- Operators tied up in non-value added maintenance time fixing equipment and running time operating the tool.

Typical Cost Savings After Five Years

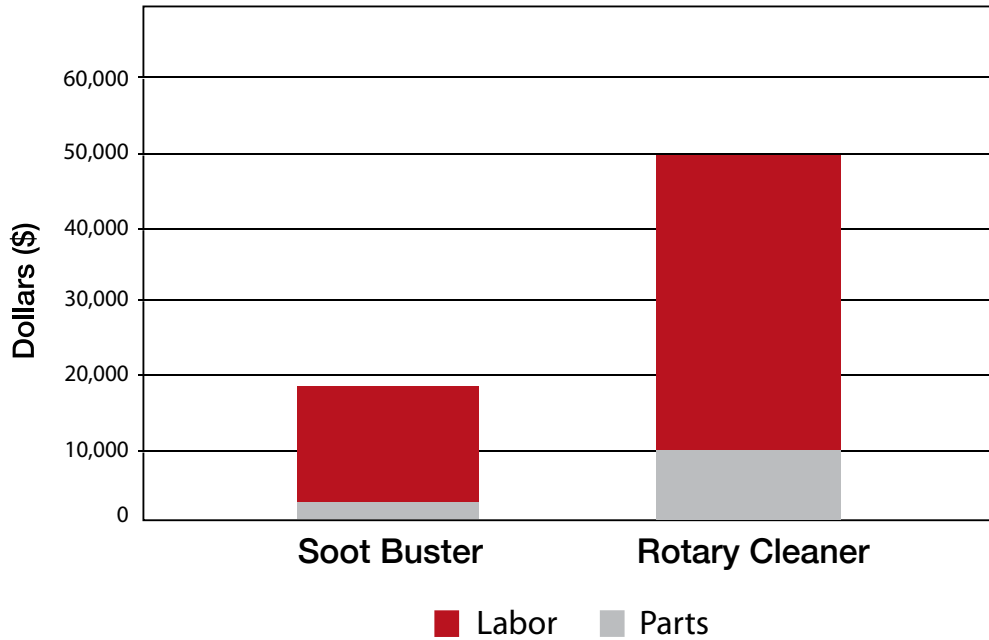

The Solution

After Chris' operators tried the Soot Buster, they were impressed and immediately appreciated its key features:

- The operator stays completely dry due to dry cleaning of the tubes.
- No spinning cables, flexible shafts, or rotating rods.
- After initial system purchase, maintenance and consumables costs are very low.
- Less downtime with much faster, more efficient cleaning.
- Tool is auto-reversing at the end of the tube eliminating the need for any feed, pulling, or pushing from the operator resulting in minimum operator fatigue.
- Minimum health and safety risks.

"The Soot Buster is the best tool on the market for cleaning tubes in confined spaces."

The Results

Maintenance time and costs have been reduced by more than half. After the initial, low investment of the cleaning system, the consumable and maintenance costs are minimal. The illustration above shows the savings that Chris projects to find using the Soot Buster over a five year period.



“

Approved by all my operators as effective and easy to use as opposed to a rotary tool, cutting cleaning time by at least half.

Chris Lewis
Maintenance Manager

TURBINE STYLE STRAIGHT TUBE CLEANERS

D600, 1100 & 1300 Series

TURBINE STRAIGHT TUBE CLEANERS



D600 Series Air Turbine Style Straight Tube Cleaner

Tube Size

- 0.495" to 1.730" ID
- 12.6mm to 43.9mm ID

Tube Section

- Straight

Type

- Soft, gummy or organic
- Hard powder

Thickness

- Light
- Medium

Flush

- Dry

Air

- 11-26 CFM (0.3-0.7 M³/min.) @ 80 PSI (5.5 bar)

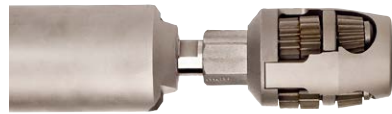

1100 Series Air Turbine Style Straight Tube Cleaner

Tube Size

- 2.250" to 13.225" ID
- 57.15mm to 335.9mm ID

Tube Section

- Straight

Type

- Soft, gummy or organic
- Hard powder

Thickness

- Light
- Medium

Flush

- Dry

Air

- 80-200 CFM (2.3-5.7 M³/min.) @ 80 PSI (5.5 bar)



1300 Series Air Turbine Style Straight Tube Cleaner

Tube Size

- 1.750" to 3.999" ID
- 44.5mm to 101.6mm ID

Tube Section

- Straight

Type

- Hard powder
- Rock solid

Thickness

- Medium
- Heavy

Flush

- Dry

Air

- 65-135 CFM (1.8-3.8 M³/min.) @ 80 PSI (5.5 bar)

The air turbine style motor design provides an immediate and powerful startup to drive the cleaning head down the tube at a high speed, removing light to medium deposits of scale, mud, and other process residues.

Features & Benefits:

- Powerful motor design allows for immediate motor startup.
- The motor requires no special tools for repair.
- Armored hose design for rigidity and heat resistance.

Spares & Accessories:

- 6070 Lubricator
- Hand & Foot Valves, [see page 145](#)
- Operating Hoses, [see page 147](#)



6070 Lubricator



TURBINE STYLE STRAIGHT TUBE CLEANERS

D600 Series - 0.495" to 1.730" (12.6 to 43.9mm)

TURBINE STRAIGHT TUBE CLEANERS

| D600 Series - 0.495" to 1.730" (12.6 to 43.9mm) | | | | | | | | | | | | | | | |
|---|-------------|-----------------|---------------------|----------------------------|--------------------|----------------------------------|---------|---------------------|-----------------|-------------------------------|--------|----------------------------------|---|----------|----------|
| Tube ID Range | | Cleaner Package | Motor Diameter | Motor Part # & Thread Size | Universal Coupling | Threaded Cone Cutter | Adapter | Brush | Flexible Holder | Operating Hose* & Pipe Thread | | | | | |
| Inch | mm | | | | | | | | | | | | | | |
| 0.495-0.532 | 12.57-13.51 | D669-15-1 | 0.468" (11.87mm) | D66900-15 10-32 | - | 16509 | 8431A | 3323-6** | 420000 | 85HS012-XX 1/8" | | | | | |
| 0.533-0.609 | 13.54-15.47 | D669-15-2 | | | | | | 3323-8** | | | | | | | |
| 0.610-0.687 | 15.49-17.45 | D670-18-1 | 0.562" (14.27mm) | D67000-18 12-24 | L69100 | 19768 | 8431B | 3324-8** | 420000BB | | | | | | |
| 0.688-0.729 | 17.48-18.52 | D670-18-2 | | | | | | 3324-10 | | | | | | | |
| 0.730-0.778 | 18.54-19.76 | D671-22-1 | 0.688" (17.48mm) | D67100-22 5/16-18 | L69300 | 16526 | 8434C | 350000 | 420100 | 85HS025-XX 1/4" | | | | | |
| 0.779-0.850 | 19.79-21.59 | D671-22-2 | | | | | | 350200 | | | | | | | |
| 0.851-0.900 | 21.62-22.86 | D671-22-3 | | | | 17702 | | 350400 | | | | | | | |
| 0.901-0.950 | 22.89-24.13 | D671-22-4 | | | | | | 350600 | | | | | | | |
| 0.951-1.000 | 24.16-25.40 | D673-28-1 | 0.875" (22.23mm) | D67300-28 5/16-18 | L69400 | 19062 | 8436A | 350800 | | | | | | | |
| 1.001-1.040 | 25.43-26.42 | D673-28-2 | | | | | | 351000 | | | | | | | |
| 1.041-1.072 | 26.44-27.23 | D673-28-3 | | | | 19840 | | 351200 | | | | | | | |
| 1.073-1.138 | 27.25-28.91 | D675-34-1 | | | | | | 351400 | | | | | | | |
| 1.139-1.206 | 28.93-30.63 | D675-34-2 | 1.062" (26.97mm) | D67500-34 3/8-16 | L69500 | 19076 | 8436C | 351600 | 420100BC | | | | | | |
| 1.207-1.230 | 30.66-31.24 | D675-34-3 | | | | | | 351800 | | | | | | | |
| 1.231-1.256 | 31.27-31.90 | D675-40-1 | | | | | | 1.250" (31.75mm) | | D67500-40 3/8-16 | L69600 | 313500 Single Pin Head Cutter | - | 352000 | 420200BD |
| 1.257-1.321 | 31.93-33.55 | D675-40-2 | 352200 | | | | | | | | | | | | |
| 1.322-1.400 | 33.58-35.56 | D675-40-3 | 1.438" (36.53mm) | D67800-46 1/2-13 | L76200A | 313600 Single Pin Head Cutter | - | | 352400 | | | | | 420300DF | |
| 1.401-1.450 | 35.59-36.83 | D678-46-1 | | | | | | | 352600 | | | | | | |
| 1.451-1.484 | 36.86-37.69 | D678-46-2 | 1.701-1.730 | 43.21-43.94 | D678-46-4 | 313700 Single Pin Head Cutter | - | 352800 | | | | | | | |
| 1.485-1.563 | 37.72-39.70 | D678-46-3 | | | | | | | | | | | | | |

* Operating Hoses are available in 25ft & 50ft sizes. XX signifies desired hose length (ex: 85HS037-25).

** Type "ST" brush available in other sizes and for curved tubes. Contact Customer Service for details.



TURBINE STYLE STRAIGHT TUBE CLEANERS

1300 Series - 1.750" to 3.999" (44.45 a 101.57mm)

TURBINE STRAIGHT TUBE CLEANERS

| 1300 Series - 1.720" to 3.999" (43.69 to 101.57mm) | | | | | | | |
|--|----------------|-----------------|---------------------|----------------------------|-------------|-----------------|-------------------------------|
| Tube ID Range | | Cleaner Package | Motor Diameter | Motor Part # & Thread Size | Cutter Head | Expanding Brush | Operating Hose* & Pipe Thread |
| Inch | mm | | | | | | |
| 1.720 - 1.780 | 43.69 - 45.21 | D77S-1 | 1.500" (38.10mm) | D7700-1500 1/2-13 | H63500 | 352900 | 85HD075-XX 3/4" |
| 1.781 - 1.820 | 45.24 - 46.23 | D77S-2 | | | | 353000 | |
| 1.821 - 1.880 | 46.25 - 47.75 | D77S-3 | | | | 353100 | |
| 1.881 - 1.920 | 47.78 - 48.77 | D77S-4 | | | | 353200A | |
| 1.921 - 1.970 | 48.79 - 50.04 | D77S-5 | | | | 353300A | |
| 1.971 - 1.999 | 50.06 - 50.77 | D77S-6 | | | | 353400A | |
| 2.000 - 2.050 | 50.80 - 52.07 | D448S-1 | 1.812" (46.02mm) | D44800-1812 5/8-11 | H63600 | 353500A | |
| 2.051 - 2.100 | 52.10 - 53.34 | D448S-2 | | | | 353600A | |
| 2.101 - 2.150 | 53.37 - 54.61 | D448S-3 | | | | 353700A | |
| 2.151 - 2.249 | 54.64 - 57.12 | D448S-4 | | | | P770A | |
| 2.250-2.499 | 57.15 - 63.47 | 1374S-1 | 2.125" (53.98mm) | 137400D2125 5/8-11 | 336000 | N770A | |
| 2.500-2.749 | 63.50 - 69.82 | 1364S-1 | 2.375" (60.33mm) | 136400D2375 3/4-10 | 336100 | R770 | |
| 2.750-2.999 | 69.85 - 76.17 | 1342S-1 | 2.625" (66.68mm) | 134200D2625 3/4-10 | | T770 | |
| 3.000-3.249 | 76.20 - 82.52 | 1393S-1 | 2.875" (73.03mm) | 139300D2875 3/4-10 | 336200 | V770 | 85HD100-XX 1" |
| 3.250-3.499 | 82.55 - 88.87 | 1325S-1 | 3.000" (76.20mm) | 132500D3000 7/8-9 | 336300 | V770A | |
| 3.500-3.749 | 88.90 - 95.22 | 1325S-2 | | | 336400 | Y770A | |
| 3.750-3.999 | 95.25 - 101.57 | 1325S-3 | | | | | |

* Operating Hoses are available in 25ft & 50ft sizes. XX signifies desired hose length (ex: 85HS037-25).



ENSURE OPTIMAL HEAT EXCHANGER PERFORMANCE

CLEAN DEPOSITS AND BLOCKED HOLES QUICKLY WITH ELLIOT'S NEW VENT HOLE CLEANER.

Elliott's new Vent Hole Cleaner is designed to clean hard deposits and navigate **challenging 90-degree bends** that water jetting just can't touch.

This innovative design utilizes a flexible cable, drill head, and coupling, allowing you to simply connect the coupling to a handheld drill and go.

Includes:

- Flexible cable
- Drill head
- Quick-connect coupling

Superior Deposit Removal

Effectively tackle even the most stubborn deposits that traditional methods leave behind.

Reduces Disassembly

Cleans hard-to-reach vent holes without removing entire components.

Avoid Costly Failures

Prevents shell-side pressure buildup and potential damage.

Optimizes System Performance

Keeps your heat exchangers running efficiently and reliably.



Learn more on pg. 146 or visit
elliott-tool.com



TURBINE STYLE STRAIGHT TUBE CLEANERS

1100 Series - 2.250" to 6.249" (57.1 to 158.7mm)

TURBINE STRAIGHT TUBE CLEANERS

| 1100 Series - 2.250" to 6.249" (57.15 to 158.72mm) | | | | | | | | |
|--|-----------------|-----------------|-----------------------|-------------|---------|----------------------|----------------------------|-------------------------------|
| Tube ID Range | | Cleaner Package | Cutter Head Selection | | | Motor Diameter | Motor Part # & Thread Size | Operating Hose* & Pipe Thread |
| Inch | mm | | Type UO | Swing Frame | Type H2 | | | |
| 2.250-2.374 | 57.15-60.30 | 1119UO-1 | 302900 | | | 2.062" (52.37mm) | 111900-2062 5/8-11 | 85HD075-XX 3/4" |
| | | 1119SF-1 | | 337300 | | | | |
| | | 1119H2-1 | | | L550 | | | |
| 2.375-2.499 | 60.33-63.47 | 1119UO-2 | 303000 | | | 2.312" (58.72mm) | 112000-2312 3/4-10 | |
| | | 1120UO-1 | | | | | | |
| 2.500-2.624 | 63.50-66.65 | 1120SF-1 | | 337300 | | 2.562" (65.07mm) | 112100-2562 3/4-10 | |
| | | 1120H2-1 | | | L550 | | | |
| 2.625-2.749 | 66.68-69.82 | 1120UO-2 | 303200 | | | 2.812" (71.42mm) | 112200-2812 7/8-9 | |
| | | 1121UO-1 | | | | | | |
| 2.750-2.874 | 69.85-73.00 | 1121SF-1 | | 337300 | | 3.062" (77.77mm) | 112300-3062 7/8-9 | |
| | | 1121H2-1 | | | 316100 | | | |
| | | 1121UO-2 | 303400 | â | | | | |
| 2.875-2.999 | 73.03-76.17 | 1121H2-2 | | | 316300 | 3.250" (82.55mm) | 112400-3250 1-14 | |
| | | 1122UO-1 | 303400 | | | | | |
| | | 1122SF-1 | | 337500 | | | | |
| 3.000-3.249 | 76.20-82.52 | 1122H2-1 | | | 316300 | 3.500" (88.90mm) | 112500-3500 1 1/8-12 | |
| | | 1123UO-1 | 303600 | | | | | |
| | | 1123SF-1 | | 337500 | | | | |
| 3.250-3.499 | 82.55-88.87 | 1123H2-1 | | | 316300 | 3.750" (95.25mm) | 112600-3750 1 1/8-12 | |
| | | 1124UO-1 | 303600 | | | | | |
| | | 1124SF-1 | | 337300 | | | | |
| 3.500-3.749 | 88.90-95.22 | 1124H2-1 | | | 316300 | 4.750" (120.65mm) | 112800B4750 1 3/8-12 | |
| | | 1125UO-1 | 303800 | | | | | |
| | | 1125SF-1 | | 337700 | | | | |
| 3.750-3.999 | 95.25-101.57 | 1125H2-1 | | | 316500 | 4.750" (120.65mm) | 112800B4750 1 3/8-12 | |
| | | 1126UO-1 | 303800 | | | | | |
| | | 1126SF-1 | | 337700 | | | | |
| 4.000-4.249 | 101.60-107.92 | 1126H2-1 | | | 316500 | 4.750" (120.65mm) | 112800B4750 1 3/8-12 | |
| | | 1126UO-2 | 304000 | | | | | |
| | | 1126SF-1 | | 337700 | | | | |
| 4.250-4.499 | 107.95-114.27 | 1126H2-1 | | | 316500 | 4.750" (120.65mm) | 112800B4750 1 3/8-12 | |
| | | 1126UO-4 | 304100 | | | | | |
| | | 1126SF-1 | | 337700 | | | | |
| 4.500-4.749 | 114.30-120.62 | 1126H2-2 | | | 316700 | 4.750" (120.65mm) | 112800B4750 1 3/8-12 | |
| | | 1126UO-3 | 304200 | | | | | |
| | | 1126SF-1 | | 337900 | | | | |
| 4.750-4.999 | 120.65-126.97 | 1126H2-2 | | | 316700 | 4.750" (120.65mm) | 112800B4750 1 3/8-12 | |
| | | 1128UO-1 | 304200 | | | | | |
| | | 1128SF-1 | | 337900 | | | | |
| 5.000-5.249 | 127.00-133.32 | 1128H2-1 | | | 316700 | 4.750" (120.65mm) | 112800B4750 1 3/8-12 | |
| | | 1128UO-2 | 304400 | | | | | |
| | | 1128SF-1 | | 337900 | | | | |
| 5.250-5.499 | 133.35-139.67 | 1128H2-1 | | | 316700 | 4.750" (120.65mm) | 112800B4750 1 3/8-12 | |
| | | 1128UO-3 | 304500 | | | | | |
| | | 1128SF-1 | | 337900 | | | | |
| 5.500 - 5.599 | 139.70 - 142.21 | 1128H2-2 | | | 316800 | 4.750" (120.65mm) | 112800B4750 1 3/8-12 | |
| | | 1128UO-3 | 304500 | | | | | |
| | | 1128SF-2 | | 338000 | | | | |
| 6.000-6.249 | 152.40-158.72 | 1128H2-2 | | | 316800 | 4.750" (120.65mm) | 112800B4750 1 3/8-12 | |
| | | 1128SF-2 | | 338000 | | | | |

* Operating Hoses are available in 25ft & 50ft sizes. XX signifies desired hose length (ex: 85HS037-25).



TURBINE STYLE STRAIGHT TUBE CLEANERS

1100 Series - 6.250" to 9.475" (158.8 to 240.7mm)

For 1100 Series, tube ID range 6.250" to 13.225" (158.8mm to 335.9mm) air turbine motors will be equipped with motor sleeves to allow the use of small, lightweight motors, reducing the size of the operating hose required.

TURBINE STRAIGHT TUBE CLEANERS

| 1100 Series - 6.250" to 9.475" (158.8 to 240.7mm) | | | | | | | | | | | | |
|---|---------------|------------------|-------------|---------|-----------------|-----------------------|----------------------|----------------------------|--------------------|-------------------------------|-----------------|---------------|
| Tube ID Range | | Application | Cutter Head | | Cleaner Package | Motor Sleeve Diameter | Motor Diameter | Motor Part # & Thread Size | Universal Coupling | Spares & Accessories | | |
| Inch | mm | | Swing Frame | Type H2 | | | | | | Operating Hose* & Pipe Thread | Extension Piece | Fiveway Drill |
| 6.250-6.475 | 158.75-164.46 | Heavy Duty | 338000 | | 1126SF-2 | 6.000" (152.40mm) | 3.750" (95.25mm) | 112600-3750 1 1/8-12 | L45000 | 85HD100-XX 1" | 4072C | H2509-1125 |
| | | Extra Heavy Duty | 338000 | 316900 | 1126H2-3 | | 4.750" (120.65mm) | 112800B4750 1 3/8-12 | | 85HD125-XX 1-1/4" | 4073C | |
| 6.500-6.725 | 165.10-170.82 | Heavy Duty | 338000 | | 1126SF-2 | 6.250" (158.75mm) | 3.750" (95.25mm) | 112600-3750 1 1/8-12 | L45000 | 85HD100-XX 1" | 4072C | |
| | | Extra Heavy Duty | 338000 | 316900 | 1126H2-3 | | 4.750" (120.65mm) | 112800B4750 1 3/8-12 | | 85HD125-XX 1-1/4" | 4073C | |
| 6.750-6.975 | 171.45-177.17 | Heavy Duty | 338000 | | 1126SF-2 | 6.500" (165.10mm) | 3.750" (95.25mm) | 112600-3750 1 1/8-12 | L45000 | 85HD100-XX 1" | 4072C | |
| | | Extra Heavy Duty | 338000 | 316900 | 1126H2-3 | | 4.750" (120.65mm) | 112800B4750 1 3/8-12 | | 85HD125-XX 1-1/4" | 4073C | |
| 7.000-7.225 | 177.80-183.52 | Heavy Duty | | | 1126H2-3 | 6.625" (168.28mm) | 3.750" (95.25mm) | 112600-3750 1 1/8-12 | L45000 | 85HD100-XX 1" | 4072C | |
| | | Extra Heavy Duty | | | 1128H2-3 | | 4.750" (120.65mm) | 112800B4750 1 3/8-12 | | 85HD125-XX 1-1/4" | 4073C | |
| 7.250-7.475 | 184.15-189.87 | Heavy Duty | | | 1126H2-3 | 6.875" (174.63mm) | 3.750" (95.25mm) | 112600-3750 1 1/8-12 | L45000 | 85HD100-XX 1" | 4072C | |
| | | Extra Heavy Duty | | | 1128H2-3 | | 4.750" (120.65mm) | 112800B4750 1 3/8-12 | | 85HD125-XX 1-1/4" | 4073C | |
| 7.500-7.725 | 190.50-196.22 | Heavy Duty | | | 1126H2-4 | 7.125" (180.98mm) | 3.750" (95.25mm) | 112600-3750 1 1/8-12 | L45000 | 85HD100-XX 1" | 4072C | |
| | | Extra Heavy Duty | | | 1128H2-3 | | 4.750" (120.65mm) | 112800B4750 1 3/8-12 | | 85HD125-XX 1-1/4" | 4073C | |
| 7.750-7.975 | 196.85-202.57 | Heavy Duty | | | 1126H2-4 | 7.375" (187.33mm) | 3.750" (95.25mm) | 112600-3750 1 1/8-12 | L45000 | 85HD100-XX 1" | 4072C | |
| | | Extra Heavy Duty | | | 1128H2-3 | | 4.750" (120.65mm) | 112800B4750 1 3/8-12 | | 85HD125-XX 1-1/4" | 4073C | |
| 8.000-8.225 | 203.20-208.92 | Heavy Duty | | | 1126H2-4 | 7.625" (193.68mm) | 3.750" (95.25mm) | 112600-3750 1 1/8-12 | L45000 | 85HD100-XX 1" | 4072E | |
| | | Extra Heavy Duty | | | 1128H2-3 | | 4.750" (120.65mm) | 112800B4750 1 3/8-12 | | 85HD125-XX 1-1/4" | 4073E | |
| 8.250-8.475 | 209.55-215.27 | Heavy Duty | | | 1126H2-4 | 7.875" (200.03mm) | 3.750" (95.25mm) | 112600-3750 1 1/8-12 | L45000 | 85HD100-XX 1" | 4072E | |
| | | Extra Heavy Duty | | | 1128H2-3 | | 4.750" (120.65mm) | 112800B4750 1 3/8-12 | | 85HD125-XX 1-1/4" | 4073E | |
| 8.500-8.725 | 215.90-221.62 | Heavy Duty | | | 1126H2-4 | 8.125" (206.38mm) | 3.750" (95.25mm) | 112600-3750 1 1/8-12 | L45000 | 85HD100-XX 1" | 4072E | |
| | | Extra Heavy Duty | | | 1128H2-3 | | 4.750" (120.65mm) | 112800B4750 1 3/8-12 | | 85HD125-XX 1-1/4" | 4073E | |
| 8.750-8.975 | 222.25-227.97 | Heavy Duty | | | 1126H2-4 | 8.375" (212.73mm) | 3.750" (95.25mm) | 112600-3750 1 1/8-12 | L45000 | 85HD100-XX 1" | 4072E | |
| | | Extra Heavy Duty | | | 1128H2-3 | | 4.750" (120.65mm) | 112800B4750 1 3/8-12 | | 85HD125-XX 1-1/4" | 4073E | |
| 9.000-9.225 | 228.60-234.32 | Heavy Duty | | | 1126H2-4 | 8.625" (219.08mm) | 3.750" (95.25mm) | 112600-3750 1 1/8-12 | L45000 | 85HD100-XX 1" | 4072E | |
| | | Extra Heavy Duty | | | 1128H2-3 | | 4.750" (120.65mm) | 112800B4750 1 3/8-12 | | 85HD125-XX 1-1/4" | 4073E | |
| 9.250-9.475 | 234.95-240.67 | Heavy Duty | | | 1126H2-4 | 8.875" (224.43mm) | 3.750" (95.25mm) | 112600-3750 1 1/8-12 | L45000 | 85HD100-XX 1" | 4072G | |
| | | Extra Heavy Duty | | | 1128H2-3 | | 4.750" (120.65mm) | 112800B4750 1 3/8-12 | | 85HD125-XX 1-1/4" | 4073G | |

* Operating Hoses are available in 25ft & 50ft sizes. XX signifies desired hose length (ex: 85HS037-25).



TURBINE STYLE STRAIGHT TUBE CLEANERS

1100 Series - 9.500" to 13.225" (241.3 to 335.3mm)

TURBINE STRAIGHT TUBE CLEANERS

| 1100 Series - 9.500" to 13.225" (241.3 to 335.3mm) | | | | | | | | | | | | | |
|--|---------------|--------------------|-------------|--------------------|--------------------|-----------------------|-------------------|----------------------------|----------------------|-------------------------------|-------------------|---------------|-------|
| Tube ID Range | | Application | Cutter Head | | Cleaner Package | Motor Sleeve Diameter | Motor Diameter | Motor Part # & Thread Size | Universal Coupling | Spares & Accessories | | | |
| Inch | mm | | Swing Frame | Type H2 | | | | | | Operating Hose* & Pipe Thread | Extension Piece | Fiveway Drill | |
| 9.500-9.725 | 241.30-247.02 | Heavy Duty | - | 317100 | 1126H2-4 | 9.125" (231.78mm) | 3.750" (95.25mm) | 112600-3750 1 1/8-12 | L45000 | 85HD100-XX 1" | 4072G | H2509-1125 | |
| | | Extra Heavy Duty | | | 1128H2-3 | | 4.750" (120.65mm) | 112800B4750 1 3/8-12 | L75500A | 85HD125-XX 1-1/4" | 4073G | | |
| 9.750-9.975 | 247.65-253.37 | Heavy Duty | | | 1126H2-4 | 9.375" (238.13mm) | 3.750" (95.25mm) | 112600-3750 1 1/8-12 | L45000 | 85HD100-XX 1" | 4072G | | |
| | | Extra Heavy Duty | | | 1128H2-3 | | 4.750" (120.65mm) | 112800B4750 1 3/8-12 | L75500A | 85HD125-XX 1-1/4" | 4073G | | |
| 10.000-10.225 | 254.00-259.72 | Heavy Duty | | | 1126H2-4 | 328000 | 9.625" (244.48mm) | 3.750" (95.25mm) | 112600-3750 1 1/8-12 | L45000 | 85HD100-XX 1" | | 4072G |
| 10.250-10.475 | 260.35-266.07 | Extra Heavy Duty | | | 1128H2-3 | | 9.875" (250.83mm) | 4.750" (120.65mm) | 112800B4750 1 3/8-12 | L75500A | 85HD125-XX 1-1/4" | | 4073G |
| 10.500-10.725 | 266.70-272.24 | | | | 10.125" (257.18mm) | | | | | | | | |
| 10.750-10.975 | 273.05-278.77 | | | | 10.375" (263.53mm) | | | | | | | | |
| 11.000-11.225 | 279.40-285.12 | | | 10.625" (269.88mm) | | | | | | | | | |
| 11.250-11.475 | 285.75-291.47 | | | 10.875" (276.23mm) | | | | | | | | | |
| 11.500-11.725 | 292.10-297.82 | | | 11.125" (282.58mm) | 4073J | | | | | | | | |
| 11.750-11.975 | 298.45-304.17 | | | 11.375" (288.93mm) | | | | | | | | | |
| 12.000-12.225 | 304.89-310.52 | | | 11.625" (295.28mm) | | | | | | | | | |
| 12.250-12.475 | 311.15-316.87 | | | 11.875" (301.63mm) | | | | | | | | | |
| 12.500-12.725 | 317.50-323.22 | | | 12.125" (307.98mm) | 4073N | | | | | | | | |
| 12.750-12.925 | 323.85-329.57 | 12.375" (314.33mm) | | | | | | | | | | | |
| 13.000-13.225 | 330.20-335.92 | 12.625" (320.68mm) | | | | | | | | | | | |

Note: Operating hoses are sold separately for these Cleaner Packages.

* Operating Hoses are available in 25ft & 50ft sizes. XX signifies desired hose length (ex: 85HS037-25).



TURBINE STYLE CURVED TUBE CLEANERS

D600, 1100 & 1300 Series



D600 Series Air Turbine Style Curved Tube Cleaner

Tube Size

- 0.791" to 2.124" ID
- 20.1mm to 54.0mm ID

Tube Section

- Curved

Type

- Soft, gummy or organic
- Hard powder

Thickness

- Light
- Medium

Flush

- Dry

Air

- 111-26 CFM (0.3-0.7 M3/min.) @ 80 PSI (5.5 bar)



1100 Series Air Turbine Style Curved Tube Cleaner

Tube Size

- 5.000" to 13.225" ID
- 127.0mm to 335.9mm ID

Tube Section

- Curved

Type

- Soft, gummy or organic
- Hard powder

Thickness

- Light
- Medium

Flush

- Dry

Air

- 80-200 CFM (2.3-5.7 M3/min.) @ 80 PSI (5.5 bar)



1300 Series Air Turbine Style Curved Tube Cleaner

Tube Size

- 2.125" to 4.999" ID
- 54.0mm to 127mm ID

Tube Section

- Curved

Type

- Hard powder
- Rock solid

Thickness

- Medium
- Heavy

Flush

- Dry

Air

- 65-135 CFM (1.8-3.8 M3/min.) @ 80 PSI (5.5 bar)

The air turbine style motor design provides an immediate and powerful startup to drive the cleaning head down the tube at a high speed, removing light to medium deposits of scale, mud, and other process residues.

Features & Benefits:

- Powerful motor design allows for immediate motor startup.
- The motor requires no special tools for repair.
- Armored hose design for rigidity and heat resistance.

Spares & Accessories:

- 6070 Lubricator
- Hand & Foot Valves, [see page 145](#)
- Operating Hoses, [see page 147](#)



6070 Lubricator



TURBINE STYLE CURVED TUBE CLEANERS

D600 Series - 0.791" to 2.124" (20.1 to 4.0mm)

TURBINE CURVED TUBE CLEANERS

| Tube ID Range | | Min. Bend Radius | Cleaner Package | Motor Diameter | Motor Part # & Thread Size | Universal Coupling | Cone Cutter | Adapter | Expanding Brush | Flexible Holder | Operating Hose* & Pipe Thread |
|---------------|-------------|----------------------|---------------------|----------------------|----------------------------|--------------------|-------------|---------|-----------------|-----------------|-------------------------------|
| Inch | mm | | | | | | | | | | |
| 0.791-0.815 | 20.09-20.70 | 6.000" (152.40mm) | D661-22-1 | 0.687" (17.45mm) | D66100-22 5/16-18 | L69300 | 17702 | 8434A | 350000 | 420000CC | **85HS025-XX 3/16" |
| 0.816-0.890 | 20.73-22.61 | | D661-22-2 | | | | | | 350200 | | |
| 0.891-0.910 | 22.63-23.11 | | D661-22-3 | | | | | | 350400 | | |
| 0.911-0.940 | 23.14-23.88 | | D662-25-1 | 0.781" (19.84mm) | D66200-25 5/16-18 | L69400 | 19062 | 8436A | 350600 | 420100 | |
| 0.941-1.040 | 23.90-26.42 | | D663-28-1 | 0.875" (22.22mm) | D66300-28 5/16-18 | | | | 19840 | | |
| 1.041-1.100 | 26.44-27.94 | | D663-28-2 | 0.968" (24.59mm) | D66300-31 5/16-18 | L69400 | 19076 | 8436C | 351000 | 420100 | |
| 1.101-1.140 | 27.97-28.96 | | D663-31-1 | | | | | | 351200 | | |
| 1.141-1.180 | 28.98-29.97 | | D663-31-2 | | | | | | 351400 | | |
| 1.181-1.242 | 30.00-31.55 | | D665-34-1 | 1.062" (26.55mm) | D66500-34 3/8-16 | L69500 | 19077 | 8436E | 351600 | 420100BC | |
| 1.243-1.270 | 31.57-32.26 | | D665-34-2 | | | | | | 351800 | | |
| 1.271-1.300 | 32.28-33.02 | | D665-34-3 | | | L69600 | 19078 | 8440A | 352000 | 420200BD | |
| 1.301-1.360 | 33.05-34.54 | | D665-34-4 | | | | | | 352200 | | |
| 1.361-1.410 | 34.57-35.81 | D665-34-5 | 352400 | | | | | | | | |
| 1.411-1.445 | 35.84-36.70 | D665-40-1 | 1.250" (31.75mm) | D66500-40 3/8-16 | L69600 | 19813 | 8440A | 352600 | 420300DD | | |
| 1.446-1.490 | 36.73-37.85 | D668-46-1 | | | | | | 352800 | | | |
| 1.491-1.525 | 37.87-38.74 | D668-46-2 | | | | | | 352900 | | | |
| 1.526-1.600 | 38.76-40.64 | D668-46-3 | 1.437" (36.50mm) | D66800-46 7/16-14 | L45500 | 19814 | 353000 | 353200A | 420300DD | | |
| 1.601-1.640 | 40.67-41.66 | D668C52-1 | | | | | | 353400A | | | |
| 1.641-1.680 | 41.68-42.67 | D668C52-2 | | | | | | 353600 | | | |
| 1.681-1.725 | 42.70-43.82 | 20.00" (508.00mm) | D668C52-1 | 1.625" (41.28mm) | D66800C52 7/16-14 | 313800 | | 353800 | 420300DD | | |
| 1.726-1.772 | 43.84-45.01 | | | | | | | 354000 | | | |
| 1.773-1.820 | 45.03-46.23 | | | | | | | 354200 | | | |
| 1.821-1.910 | 46.25-48.51 | | | | | | | 354400 | | | |
| 1.911-2.000 | 48.54-50.80 | 20.00" (508.00mm) | D668C52-1 | 1.625" (41.28mm) | D66800C52 7/16-14 | 313800 | | 354600 | 420300DD | | |
| 2.001-2.040 | 50.83-51.82 | | | | | | | 354800 | | | |
| 2.041-2.124 | 51.84-53.95 | | | | | | | 355000 | | | |

* Operating Hoses are available in 25ft & 50ft sizes. XX signifies desired hose length (ex: 85HS037-25).

** Recommend use with Air Valve 720200. Air Valve sold separately.

*** Recommend use with Air Valve 720300. Air Valve sold separately.

**** Recommend use with Air Valve 720400. Air Valve sold separately.



TURBINE STYLE CURVED TUBE CLEANERS

1300 Series - 2.125" to 4.999" (54.0 to 127.0mm)

TURBINE CURVED TUBE CLEANERS

| 1300 Series - 2.125" to 4.999" (54.0 to 127.0mm) | | | | | | | | | | | |
|--|---------------|------------------|--------|-----------------|---------------------|----------------------------|--------------------|-------------|----------------|-------------------------------|-----------|
| Tube ID Range | | Min. Bend Radius | | Cleaner Package | Motor Diameter | Motor Part # & Thread Size | Universal Coupling | Cutter Head | Type "G" Brush | Operating Hose* & Pipe Thread | Air Valve |
| Inch | mm | Inch | mm | | | | | | | | |
| 2.125-2.249 | 53.98-57.12 | 12.000 | 304.80 | 1370C-1 | 1.750" (44.45mm) | 137000C1750 1/2-13 | | | 3145-6 | 85HD050-XX 1/2" | 720400 |
| 2.250-2.374 | 57.15-60.30 | 9.000 | 228.60 | | | | | | | | |
| 2.375-2.499 | 60.33-63.47 | 12.000 | 304.80 | 1395C-1 | 1.875" (47.63mm) | 139500C1875 1/2-13 | L76200A | 336000 | 3145-8 | | 720500 |
| 2.500-2.624 | 63.50-66.68 | 9.000 | 228.60 | 1395C-2 | | | | | | | |
| 2.625-2.749 | 66.68-69.82 | 10.000 | 254.00 | 1395C-3 | 2.125" (53.98mm) | 137400D2125 5/8-11 | L27600 | 336100 | 3146-2 | | 720600 |
| 2.750-2.874 | 69.85-73.00 | 15.000 | 381.00 | 1374C-1 | | | | | | | |
| 2.875-2.999 | 73.03-76.17 | 11.000 | 297.40 | 1374C-2 | 2.375" (60.33mm) | 136400D2375 3/4-10 | L52200 | 336200 | 3147-4 | 85HD075-XX 3/4" | 720500 |
| 3.000-3.249 | 76.20-82.52 | 11.000 | 297.40 | 1374C-3 | | | | | | | |
| 3.250-3.499 | 82.55-88.87 | 14.000 | 355.60 | 1364C-1 | 2.625" (66.68mm) | 134200D2625 3/4-10 | L28000 | 336200 | 3147-6 | | 720600 |
| 3.500-3.749 | 88.90-95.22 | 12.000 | 304.80 | 1364C-2 | | | | | | | |
| 3.750-3.99 | 95.25-101.57 | 21.000 | 533.40 | 1342C-1 | 2.875" (73.03mm) | 136400D2375 3/4-10 | L52200 | 336200 | 3151-2 | | 720500 |
| 4.000-4.249 | 101.60-107.92 | 12.000 | 304.80 | 1364C-3 | | | | | | | |
| 4.250-4.499 | 107.95-114.27 | 15.000 | 381.00 | 1342C-2 | 3.000" (76.20mm) | 132500D3000 7/8-9 | L28000 | 336300 | 3151-4 | | 720600 |
| 4.500-4.749 | 117.30-120.62 | 13.000 | 330.20 | 1342C-1 | | | | | | | |
| 4.750-4.999 | 120.65-126.97 | 16.000 | 406.40 | 1393C-1 | 3.625" (92.08mm) | 139300D2875 3/4-10 | L28000A | 336300 | 3196-8 | | 720600 |
| | | 18.000 | 457.20 | 1393C-2 | | | | | | | |
| | | 14.000 | 355.60 | 1325C-1 | 3.000" (76.20mm) | 132500D3000 7/8-9 | L37300 | 336400 | 3196-10 | 85HD100-XX 1" | 720600 |
| | | 18.000 | 457.20 | 1325C-2 | | | | | | | |
| | | 16.000 | 406.40 | 1399C-1 | 3.625" (92.08mm) | 139900D3625 1 1/8-12 | L51000 | 316500 | 3196-10 | 85HD100-XX 1" | 720600 |
| | | 21.000 | 533.40 | 1325C-2 | | | | | | | |
| | | 16.000 | 406.40 | 1399C-1 | 3.625" (92.08mm) | 139900D3625 1 1/8-12 | L51000 | 316500 | 3196-10 | 85HD100-XX 1" | 720600 |
| | | 18.000 | 457.20 | 1399C-1 | | | | | | | |

Note: Operating hoses are sold separately for these Cleaner Packages.

* Operating Hoses are available in 25ft & 50ft sizes. XX signifies desired hose length (ex: 85HS037-25).



TURBINE STYLE CURVED TUBE CLEANERS

1100 Series - 5.000" to 9.975" (127.0 to 253.4mm)

For 1100 Series, tube ID range 6.250" to 13.225" (158.8mm to 335.9mm) air turbine motors will be equipped with motor sleeves to allow the use of small, lightweight motors, reducing the size of the operating hose required.

TURBINE CURVED TUBE CLEANERS

| 1100 Series - 5.000" to 9.975" (127.0 to 253.4mm) | | | | | | | | | | | | | | | | | |
|---|---------------|--------------------|----------------------|-----------------------|--------------------------|----------------------------|--------------------|----------|----------------|-------------------------------|---------------------|--------------------------|--------------------------|---------|--------|--------|------------|
| Tube ID Range | | Min. Bend Radius | Cleaner Package | Motor Sleeve Diameter | Motor Diameter | Motor Part # & Thread Size | Universal Coupling | | H2 Cutter Head | Operating Hose* & Pipe Thread | Extension Piece | Fifeway Drill | | | | | |
| Inch | mm | | | | | | HD | Extra HD | | | | | | | | | |
| 5.000-5.225 | 127.00-132.72 | 25.00" (635mm) | 1126CH2-1 | 4.250" (107.95mm) | 3.750" (95.25mm) | 112600-3750 1 1/8-12z | L45000 | | 316800 | 8418L | H2347-750 | | | | | | |
| 5.250-5.475 | 133.35-139.07 | | | 4.500" (114.30mm) | | | | | | | | | | | | | |
| 5.500-5.725 | 139.70-145.42 | | | 4.750" (120.65mm) | | | | | | | | | | | | | |
| 5.750-5.975 | 146.05-151.77 | | | 5.000" (127.00mm) | | | | | | | | | | | | | |
| 6.000-6.225 | 152.40-158.12 | za.00" (762mm) | 1126CH2-2z | 5.250" (133.35mm) | 3.750" (95.25mm) | 112600-3750 1 1/8-12z | L45000 | | 316900 | 4072C | | | | | | | |
| 6.250-6.475 | 158.75-164.47 | | | 5.500" (139.70mm) | | | | | | | | | | | | | |
| 6.500-6.725 | 165.10-170.82 | | | 5.750" (146.05mm) | | | | | | | | | | | | | |
| 6.750-6.975 | 171.45-177.17 | | | 6.000" (152.40mm) | | | | | | | | | | | | | |
| 7.000-7.225 | 177.80-183.52 | 35.00" (889mm) | 1126CH2-3 | 6.250" (158.75mm) | 3.750" (95.25mm) | 112600-3750 1 1/8-12z | L45000 | | 317100 | 4073E | H2509-1125 | | | | | | |
| 7.250-7.475 | 184.15-189.87 | | | 6.500" (165.10mm) | | | | | | | | | | | | | |
| 7.500-7.725 | 190.50-196.22 | | | 6.875" (174.63mm) | | | | | | | | | | | | | |
| 7.750-7.975 | 196.85-202.57 | | | 7.125" (180.98mm) | | | | | | | | | | | | | |
| 8.000-8.225 | 203.20-208.92 | 40.00" (1016mm) | 1126CH2-3 | 7.125" (180.98mm) | 3.750" (95.25mm) | 112600-3750 1 1/8-12z | L75600A | | 317100 | 4073E | H2509-1125 | | | | | | |
| 8.250-8.475 | 209.55-215.27 | | 1128CH2-1** | 4.750" (120.65mm) | | | | | | | | | | | | | |
| | | | 1126CH2-3 | 7.375" (187.33mm) | | | | | | | | | | | | | |
| 8.500-8.725 | 215.90-221.62 | | 1126CH2-3 | 7.625" (193.68mm) | | | | | | | | 3.750" (95.25mm) | 112600-3750 1 1/8-12z | L75600A | | 317100 | 4073E |
| | | 1128CH2-1** | 4.750" (120.65mm) | | | | | | | | | | | | | | |
| 8.750-8.975 | 222.25-227.97 | 1126CH2-3 | 7.875" (200.03mm) | 3.750" (95.25mm) | 112600-3750 1 1/8-12z | L75600A | | 317100 | 4073E | H2509-1125 | | | | | | | |
| | | 1128CH2-1** | 4.750" (120.65mm) | | | | | | | | | | | | | | |
| 9.000-9.225 | 228.60-234.32 | 1126CH2-4 | 8.125" (206.38mm) | | | | | | | | 3.750" (95.25mm) | 112600-3750 1 1/8-12z | L75600A | | 317200 | 4073G | H2509-1125 |
| | | 1128CH2-2** | 4.750" (120.65mm) | | | | | | | | | | | | | | |
| 9.250-9.475 | 234.95-240.67 | 1126CH2-4 | 8.375" (212.73mm) | 3.750" (95.25mm) | 112600-3750 1 1/8-12z | L75600A | | 317200 | 4073G | H2509-1125 | | | | | | | |
| | | 1128CH2-2** | 4.750" (120.65mm) | | | | | | | | | | | | | | |
| 9.500-9.725 | 241.30-247.02 | 1126CH2-4 | 8.625" (219.08mm) | | | | | | | | 3.750" (95.25mm) | 112600-3750 1 1/8-12z | L75600A | | 317200 | 4073G | H2509-1125 |
| | | 1128CH2-2** | 4.750" (120.65mm) | | | | | | | | | | | | | | |
| 9.750-9.975 | 247.65-253.37 | 1126CH2-4 | 8.875" (225.43mm) | 3.750" (95.25mm) | 112600-3750 1 1/8-12z | L75600A | | 317200 | 4073G | H2509-1125 | | | | | | | |
| | | 1128CH2-2** | 4.750" (120.65mm) | | | | | | | | | | | | | | |

Note: Operating hoses are sold separately for these Cleaner Packages.

* Operating Hoses are available in 25ft & 50ft sizes. XX signifies desired hose length (ex: 85HS037-25). **For extra heavy duty cleaning applications.



TURBINE STYLE CURVED TUBE CLEANERS

1100 Series - 10.000" to 13.225" (254.0 to 335.2mm)

TURBINE CURVED TUBE CLEANERS

| 1100 Series - 10.000" to 13.225" (254.0 to 335.2mm) | | | | | | | | | | | | |
|---|----------------------|-----------------------|-----------------------|-------------------------|----------------------|----------------------------|--------------------|------------------|----------------------|-------------------------------|-----------------|-----------------------|
| Tube ID Range | | Min. Bend Radius | Cleaner Package | Motor Sleeve Diameter | Motor Diameter | Motor Part # & Thread Size | Universal Coupling | | H2 Cutter Head | Operating Hose* & Pipe Thread | Extension Piece | Fiveway Drill |
| Inch | mm | | | | | | Heavy Duty | Extra Heavy Duty | | | | |
| 10.000-10.225 | 254.00-259.72 | 50.00" (1270mm) | 1126CH2-4 | 9.125" (231.78mm) | 3.750" (95.25mm) | 112600-3750 1 1/8-12 | L75600 | | 317200 | 85HD100-XX 1" | 4073G | |
| | | | 1128CH2-2** | | 4.750" (120.65mm) | | | | | 112800B4750 1 3/8-12 | | |
| 1126CH2-4 | 9.375" (238.13mm) | | 3.750" (95.25mm) | 112600-3750 1 1/8-12 | 85HD100-XX 1" | | | | | | | |
| 1128CH2-2 | | | 9.625" (244.48mm) | | 4.750" (120.65mm) | 112800B4750 1 3/8-12 | | | | 85HD125-XX 1-1/4" | | |
| 10.500-10.725 | 266.70-272.42 | | 9.875" (250.83mm) | | | | | | | | | |
| 10.750-10.975 | 273.05-278.77 | | 10.125" (257.18mm) | | | | | | | | | |
| 11.000-11.225 | 279.40-285.12 | 10.375" (263.53mm) | | | | | | | | | | |
| 11.250-11.475 | 285.75-291.47 | 10.625" (269.88mm) | | | | | | | | | | |
| 11.500-11.725 | 292.10-297.82 | 10.875" (276.23mm) | | | | | | | | | | |
| 11.750-11.975 | 298.45-304.17 | 55.00" (1397mm) | 1128CH2-3** | 11.125" (282.58mm) | L75600A | L75600 | | 328000 | 85HD125-XX 1-1/4" | 4073J | H1059-1125 | |
| 12.000-12.225 | 304.80-310.52 | | | 11.375" (288.93mm) | | | | | | | | |
| 12.250-12.475 | 311.15-316.87 | | | 11.625" (295.28mm) | | | | | | | | |
| 12.500-12.725 | 317.50-323.22 | | | 11.875" (301.63mm) | | | | | | | | |
| 12.750-12.975 | 323.85-329.57 | | | 12.125" (307.8mm) | | | | | | | | |
| 13.000-13.225 | 330.20-335.92 | | | 60.00" (1524mm) | | | | | | 1128CH2-3** | | 11.125" (282.58mm) |
| 12.250-12.475 | 311.15-316.87 | 11.375" (288.93mm) | | | | | | | | | | |
| 12.500-12.725 | 317.50-323.22 | 11.625" (295.28mm) | | | | | | | | | | |
| 12.750-12.975 | 323.85-329.57 | 11.875" (301.63mm) | | | | | | | | | | |
| 13.000-13.225 | 330.20-335.92 | 12.125" (307.8mm) | | | | | | | | | | |

Note: Operating hoses are sold separately for these Cleaner Packages.

* Operating Hoses are available in 25ft & 50ft sizes. XX signifies desired hose length (ex: 85HS037-25). **For extra heavy duty cleaning applications.



TURBINE STYLE CURVED TUBE CLEANERS

Cleaning Heads

TURBINE CURVED TUBE CLEANERS

Threaded Cone Cutter

Tube Section: Straight or Curved
Deposit: Light – Medium
Distribution: Even or Uneven
Cleaner Series: D600 Series - smaller ID's



Single Pin Head

Tube Section: Straight or Curved
Deposit: Light – Medium
Distribution: Even or Uneven
Cleaner Series: D600 Series - larger ID's



| Tube ID Range | | Head | Thread | Adapter | Adapter Thread |
|---------------|---------------|-------|------------|---------|---------------------------|
| Inch | mm | | | | |
| 0.437 - 0.499 | 11.10 - 12.67 | 16509 | #10-32UNF | 8431A | 10-32 UNF x 10-32 UNF |
| 0.500 - 0.624 | 12.70 - 15.85 | 19768 | #10-32UNF | 8431B | 10-32 UNF x 12-24 UNC |
| 0.625 - 0.686 | 15.88 - 17.42 | 16526 | 1/4-20UNC | 8434C | 1/4-20 UNC x 5/16-18 UNC |
| 0.687 - 0.811 | 17.45 - 20.60 | 17702 | 1/4-20UNC | 8434C | 1/4-20 UNC x 5/16-18 UNC |
| 0.812 - 0.874 | 20.62 - 22.20 | 19062 | 5/16-18UNC | 8436A | 5/16-18 UNC x 5/16-18 UNC |
| 0.875 - 0.999 | 22.23 - 25.37 | 19840 | 3/8-16UNC | 8436C | 5/16-18 UNC x 3/8-16 UNC |
| 1.000 - 1.124 | 25.40 - 28.55 | 19076 | 3/8-16UNC | 8436C | 5/16-18 UNC x 3/8-16 UNC |
| 1.125 - 1.249 | 28.58 - 31.72 | 19077 | 7/16-14UNC | 8436E | 5/16-18 UNC x 7/16-14 UNC |
| 1.250 - 1.374 | 31.75 - 34.90 | 19078 | 7/16-14UNC | 8440A | 7/16-14 UNC x 7/16-14 UNC |
| 1.375 - 1.499 | 34.93 - 38.07 | 19813 | 7/16-14UNC | 8440A | 7/16-14 UNC x 7/16-14 UNC |
| 1.500 - 1.749 | 38.10 - 44.42 | 19814 | 7/16-14UNC | 8440A | 7/16-14 UNC x 7/16-14 UNC |
| 1.750 - 2.000 | 44.45 - 50.80 | 19824 | 5/8-11UNC | 8440G | 7/16-14 UNC x 5/8-11 UNC |

| Tube ID Range | | Head | Thread |
|---------------|---------------|--------|-----------|
| Inch | mm | | |
| 1.125 - 1.374 | 28.58 - 34.90 | 319000 | 3/8-16 M |
| 1.375 - 1.499 | 34.93 - 38.07 | 313400 | 3/8-16 M |
| 1.500 - 1.624 | 38.10 - 41.25 | 313500 | 7/16-14 M |
| 1.625 - 1.749 | 41.28 - 44.42 | 313600 | 7/16-14 M |
| 1.750 - 1.999 | 44.45 - 50.77 | 313700 | 7/16-14 M |
| 2.000 - 2.249 | 50.8 - 57.12 | 313800 | 7/16-14 M |
| 2.250 - 2.500 | 57.15 - 63.50 | 315800 | 5/8-11 M |



KM Drill

Tube Section: Straight
Deposit: Medium – Heavy
Distribution: Even or Uneven
Cleaner Series: 1300 Series, 1100 Series



Drill Head

Tube Section: Straight or Curved
Deposit: Medium – Heavy
Distribution: Even or Uneven
Cleaner Series: 1300 Series, 1100 Series



Type "G" Brush

Tube Section: Straight or Curved
Deposit: Light – Medium
Distribution: Even
Cleaner Series: D600 Series, 1300 Series

| Tube ID Range | | Head | Male Thread |
|---------------|---------------|-------------|-------------|
| Inch | mm | | |
| 1.500 - 1.624 | 38.10 - 41.25 | 5097-1-1/2N | 1/2-13 |
| 1.625 - 1.749 | 41.28 - 44.42 | 5097-1-5/8N | |
| 1.750 - 1.874 | 44.45 - 47.60 | 5097-1-3/4N | |
| 1.875 - 1.999 | 47.63 - 50.77 | 5097-1-7/8N | |
| 2.000 - 2.240 | 50.80 - 56.90 | 5097-2Q | 5/8-11 |
| 2.500 - 2.750 | 63.50 - 69.85 | 5097-2-1/2R | 3/4-10 |

| Tube ID Range | | Head | Male Thread |
|---------------|---------------|------------|-------------|
| Inch | mm | | |
| 1.125 - 1.374 | 28.58 - 34.90 | H1145-312 | 5/16-18 |
| 1.375 - 1.624 | 34.93 - 41.25 | H1144-437 | 7/16-14 |
| 1.500 - 1.749 | 38.10 - 44.42 | H1105-437 | |
| 1.750 - 1.999 | 44.45 - 50.77 | H1058-437 | |
| 2.000 - 2.249 | 50.80 - 57.12 | H1059-437 | |
| 2.250 - 2.499 | 57.15 - 63.47 | H1166-625 | 5/8-11 |
| 2.500 - 2.874 | 63.5 - 73.00 | H2356-625 | 3/4-10 |
| 2.875 - 3.124 | 73.03 - 79.35 | H2404-750 | |
| 3.125 - 3.374 | 79.38 - 85.70 | H2355-750 | |
| 3.375 - 3.749 | 85.73 - 95.22 | H2347-750 | |
| 3.750 - 4.250 | 95.25 - 107.9 | H2509-1125 | |

| Tube ID Range | | Brush | Male Thread |
|---------------|---------------|---------|-------------|
| Inch | mm | | |
| 1.750 - 1.999 | 44.45 - 50.77 | 3083-8 | 7/16-14 |
| 2.000 - 2.249 | 50.80 - 57.12 | 3145-4 | |
| 2.250 - 2.499 | 57.15 - 63.47 | 3145-8 | |
| 2.500 - 2.749 | 63.50 - 69.82 | 3147-4 | 5/8-11 |
| 2.750 - 2.999 | 69.85 - 76.17 | 3147-8 | 3/4-10 |
| 3.000 - 3.249 | 76.20 - 82.52 | 3196-4 | |
| 3.250 - 3.499 | 82.55 - 88.87 | 3196-8 | |
| 3.500 - 3.749 | 88.90 - 95.22 | 3196-10 | |
| 3.750 - 4.000 | 95.25 - 101.6 | 3196-10 | |



TURBINE STYLE CURVED TUBE CLEANERS

Cleaning Heads



Swing Frame- Long Surface

Tube Section: Straight
 Deposit: Medium – Heavy
 Distribution: Even
 Cleaner Series: 1300 Series, 1100 Series

| Minimum Tube ID | | Head Part Number | Expansion Range | | Spider | Spider Thread | Arm | Arm Pin | Cutter Pin | Cone Cutter | Straight Cutter | Keeper Pin | Head Lock |
|-----------------|--------|------------------|-----------------|---------------|--------|---------------|--------|---------|------------|-------------|-----------------|------------|-----------|
| Inch | mm | | Inch | mm | | | | | | | | | |
| 2.250 | 57.15 | 337300 | 2.000-2.875 | 50.80-73.03 | 337302 | 1/2"-13 M | 337304 | 337306 | 337307 | H-36008 | T-19061 | 337312 | 337346 |
| 2.625 | 66.68 | 337400 | 2.312-3.250 | 58.72-82.55 | 337402 | 1/2"-13 F | 337404 | 337306 | 337307 | H-36008 | T-19061 | 337312 | 337446 |
| 3.00 | 76.20 | 337500 | 2.625-3.625 | 66.68-92.08 | 337502 | 1/2"-13 F | 337504 | 337506 | 337507 | T-17745-A | T-16986-A | 337512 | 337546 |
| 3.750 | 95.25 | 337700 | 3.375-4.625 | 85.73-117.48 | 337702 | 3/4"-10 F | 337704 | 337606 | 337607 | T-17119 | T-16686-A | 337712 | 337746 |
| 5.000 | 127.00 | 337900 | 4.626-6.375 | 117.50-161.93 | 337902 | 1-1/8"-12 F | 337904 | 337906 | 337907 | T-16863 | T-16865 | 337912 | 337946 |
| 6.000 | 152.40 | 338000 | 5.625-7.375 | 142.88-187.33 | 338002 | 1-1/8"-12 F | 337904 | 337906 | 337907 | T-16863 | T-16865 | 337912 | 338046 |



Swing Frame- Short Surface

Tube Section: Straight, Curved
 Deposit: Medium
 Distribution: Even
 Cleaner Series: 1300 Series

| Minimum Tube ID | | Head Part Number | Expansion Range | | Spider | Spider Thread | Arm | Arm Pin | Cutter Pin | Cone Cutter | Star Cutter | Keeper Pin | Head Lock |
|-----------------|-------|------------------|-----------------|--------------|--------|---------------|--------|---------|------------|-------------|-------------|------------|-----------|
| Inch | mm | | Inch | mm | | | | | | | | | |
| 2.125 | 53.98 | 336000 | 1.937-2.875 | 49.20-73.03 | 336002 | 7/16-14 M | 336004 | 335906 | 335907 | H-35908 | H-35909 | 336012 | 336046 |
| 2.500 | 63.50 | 336100 | 2.125-3.125 | 53.98-79.38 | 336102 | 5/8-11 M | 336104 | 335906 | 335907 | H-35908 | H-35909 | 336112 | 336146 |
| 2.875 | 73.03 | 336200 | 2.875-3.500 | 73.03-88.90 | 336202 | 5/8-11 M | 336204 | 336206 | 336207 | H-36008 | H-36009 | 336212 | 336246 |
| 3.250 | 82.55 | 336300 | 3.250-3.875 | 82.55-98.43 | 336302 | 3/4-10 M | 336304 | 336206 | 336307 | T-17745 | H-36209 | 336312 | 336346 |
| 3.500 | 88.90 | 336400 | 3.500-4.250 | 88.90-107.95 | 336402 | 3/4-10 M | 336404 | 336406 | 336407 | H-36308 | H-36309 | 336412 | 336446 |



TURBINE STYLE CURVED TUBE CLEANERS

Cleaning Heads

TURBINE CURVED TUBE CLEANERS



UO Head

Tube Section: Straight
 Deposit: Heavy – Very Heavy
 Distribution: Even
 Cleaner Series: 1300 Series, 1100 Series

| Minimum Tube ID | | Head # | Expansion Range | | Spider | Spider Thread | | Center Plate | Head Lock | Cutter Pin | Cone Cutter | Straight Cutter |
|-----------------|--------|--------|-----------------|---------------|--------|---------------|-------------|--------------|-----------|------------|-------------|-----------------|
| Inch | mm | | Inch | mm | | Front | Rear | | | | | |
| 1.875 | 47.63 | 302600 | 1.750-1.937 | 44.45-49.20 | 302602 | 1/2"-13 F | 1/2"-13 F | 302634 | 302646 | 19390 | T17565 | T17564 |
| 2.00 | 50.80 | 302700 | 1.875-2.062 | 47.63-52.37 | 302702 | 1/2"-13 F | 1/2"-13 F | 302734 | 302746 | 19390 | T17565 | T17564 |
| 2.125 | 53.98 | 302800 | 2.000-2.312 | 50.80-58.72 | 302802 | 1/2"-13 F | 1/2"-13 F | 302834 | 302846 | 19390 | H36008 | T19061 |
| 2.250 | 57.15 | 302900 | 2.125-2.437 | 53.98-61.90 | 302902 | 1/2"-13 F | 1/2"-13 F | 302934 | 302946 | 19390 | H36008 | T19061 |
| 2.375 | 60.33 | 303000 | 2.250-2.625 | 57.15-66.68 | 303002 | 5/8"-11 F | 5/8"-11 F | 303034 | 303046 | 19390 | H153408 | T16986 |
| 2.500 | 63.50 | 303100 | 2.375-2.750 | 60.33-69.85 | 303102 | 5/8"-11 F | 5/8"-11 F | 303134 | 303146 | 19390 | H153408 | T16986 |
| 2.625 | 66.68 | 303200 | 2.500-2.875 | 63.50-73.03 | 303202 | 5/8"-11 F | 5/8"-11 F | 303234 | 303246 | 18414 | H36308 | T16983 |
| 2.750 | 69.85 | 303300 | 2.532-3.000 | 65.07-76.20 | 303202 | 5/8"-11 F | 5/8"-11 F | 303334 | 303346 | 18414 | T19797 | T19798 |
| 2.875 | 73.03 | 303400 | 2.687-3.187 | 68.25-80.95 | 303402 | 3/4"-10 F | 3/4"-10 F | 303434 | 303446 | 18414 | T19797 | T19798 |
| 3.000 | 76.20 | 303500 | 2.812-3.250 | 71.42-82.55 | 303502 | 3/4"-10 F | 3/4"-10 F | 303534 | 303546 | 18064 | T17119 | T16658A |
| 3.250 | 82.55 | 303600 | 3.062-3.625 | 77.77-92.08 | 303602 | 3/4"-10 F | 1"-8 F | 303634 | 303646 | 18064 | T18539 | T17910 |
| 3.500 | 88.90 | 303700 | 3.312-3.875 | 84.12-98.43 | 303702 | 3/4"-10 F | 1"-8 F | 303734 | 303746 | 18064 | T16657 | T16658A |
| 3.750 | 95.25 | 303800 | 3.562-4.250 | 90.47-107.95 | 303802 | 7/8"-9 F | 1"-8 F | 303834 | 303846 | 18086 | T19777 | T19778 |
| 4.000 | 101.60 | 303900 | 3.812-4.500 | 96.82-114.30 | 303902 | 7/8"-9 F | 1-1/8"-12 F | 303934 | 303946 | 303907 | T16863 | T16865 |
| 4.250 | 107.95 | 304000 | 4.000-4.625 | 101.60-117.48 | 303902 | 7/8"-9 F | 1-1/8"-12 F | 303934 | 304046 | 303907 | T16863 | T16865 |
| 4.500 | 114.30 | 304100 | 4.250-5.000 | 107.95-127.00 | 304102 | 7/8"-9 F | 1-1/8"-12 F | 304134 | 304146 | 303907 | T19516 | T19517 |
| 4.750 | 120.65 | 304200 | 4.500-5.250 | 114.30-133.35 | 304202 | 7/8"-9 F | 1-1/8"-12 F | 304234 | 304246 | 303907 | T19516 | T19517 |
| 5.000 | 127.00 | 304300 | 4.750-5.500 | 120.65-139.70 | 304202 | 7/8"-9 F | 1-1/8"-12 F | 304334 | 304346 | 303907 | T19516 | T19517 |
| 5.250 | 133.35 | 304400 | 5.000-5.750 | 127.00-146.05 | 304402 | 1-1/8"-12 F | 1-1/8"-12 F | 304434 | 304446 | 304507 | T17079 | T18805 |
| 5.500 | 139.70 | 304500 | 5.250-6.000 | 133.35-152.40 | 304502 | 1-1/8"-12 F | 1-1/8"-12 F | 304534 | 304546 | 304507 | T17079 | T18805 |



Clipless Head

Tube Section: Straight or Curved
 Deposit: Medium
 Distribution: Even
 Cleaner Series: 1100 Series, 1300 Series

| Minimum Tube ID | | Head # | Expansion Range | Spider | Spider Thread | Arm | Arm Pin | Cutter Pin | Cone Cutter | Straight Cutter |
|-----------------|-------|--------|--------------------------------------|--------|---------------|--------|---------|------------|-------------|-----------------|
| Inch | mm | | | | | | | | | |
| 1.750 | 44.45 | H63500 | 1-1/2" - 2" (38.10 - 50.80mm) | H63502 | 1/2-13 M | H63504 | H63506 | H63507 | T17565 | H63509 |
| 2.000 | 50.80 | H63600 | 1-3/4" - 2-1/4" (44.45 - 57.15mm) | H63602 | 5/8-11 M | H63604 | H63606 | H63607 | H46108 | H47909 |



TURBINE STYLE CURVED TUBE CLEANERS

Cleaning Heads

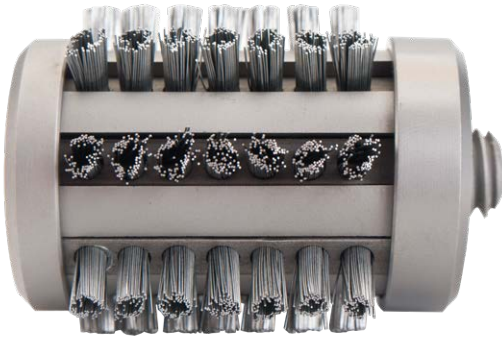

Expanding Brush/Scraper

Tube Section: Straight or Curved
 Deposit: Light
 Distribution: Even
 Cleaner Series: D600 Series, 1300 Series

| Heavy Duty Expanding Brush/Scraper | | | | |
|------------------------------------|---------------------|------------|-------------------|---------------|
| Brush Expansion | | Assembly # | Brush Refill Sets | Spider Thread |
| Min | Max | | | |
| 1.937" (49.2mm) | 2.250" (57.2mm) | P770 | N774-6 | 9/16-12 UNC |
| | | P770A | N774-6 | 7/16-14 UNC |
| | | S770 | N774-6 | 5/8-11 UNC |
| 2.062" (53.4mm) | 2.500" (63.5mm) | N770 | N774-6 | 9/16-12 UNC |
| | | N770A | N774-6 | 7/16-14 UNC |
| | | M770 | N774-6 | 5/8-11 UNC |
| 2.437" (61.9mm) | 2.750" (69.9mm) | R770 | R774-6 | 5/8-11 UNC |
| 2.687" (68.2mm) | 3.000" (76.2mm) | T770 | T774-6 | 5/8-11 UNC |
| 3.125" (79.4mm) | 3.625" (92.1mm) | V770 | V774-6 | 7/8-9 UNC |
| | | V770A | V774-6 | 3/4-10 UNC |
| 3.500" (88.9mm) | 4.187" (106.3mm) | Y770 | Y774-6 | 7/8-9 UNC |
| | | Y770A | Y774-6 | 3/4-10 UNC |
| 4.125" (104.8mm) | 5.250" (133.4mm) | H770 | X474-6 | 1-1/8 -7 UNC |
| | | H770A | X474-6 | 3/4-10 UNC |

To order an expanding scraper head assembly, add "SB-#" suffix to expanding brush assembly number (i.e. N774SB-6).



Scraper Blade

| Expanding Brush/Scraper | | | | | |
|-----------------------------|-----------------------------|------------|-------------------|--------------------|--------------|
| Tube ID Range | | Assembly # | Brush Refill Sets | Scraper Blade Sets | Frame Thread |
| Straight | Curved | | | | |
| 0.730"-0.752" (18.5-19.1mm) | 0.770"-0.790" (19.6-20.1mm) | 350000 | 350037-4 | SB1-4 | 5/16-18 M |
| 0.753"-0.778" (19.1-19.8mm) | 0.791"-0.815" (20.1-20.7mm) | 350100 | 350137-4 | SB1-4 | |
| 0.779"-0.810" (19.8-20.6mm) | 0.816"-0.850" (20.7-21.6mm) | 350200 | 350237-4 | SB2-4 | |
| 0.811"-0.850" (20.6-21.6mm) | 0.851"-0.890" (21.6-22.6mm) | 350300 | 350337-4 | SB2-4 | |
| 0.851"-0.871" (21.6-22.1mm) | 0.891"-0.910" (22.6-23.1mm) | 350400 | 350437-4 | SB3-4 | |
| 0.872"-0.900" (22.1-22.9mm) | 0.911"-0.940" (23.1-23.9mm) | 350500 | 350537-4 | SB3-4 | |
| 0.901"-0.950" (22.9-24.1mm) | 0.941"-0.990" (23.9-25.1mm) | 350600 | 350637-4 | SB4-4 | |
| 0.951"-1.000" (24.2-25.4mm) | 0.991"-1.040" (25.2-26.4mm) | 350700 | 350737-4 | SB4-4 | |
| 1.001"-1.040" (25.4-26.4mm) | 1.041"-1.075" (26.4-27.3mm) | 350800 | 350837-4 | SB5-4 | |
| 1.041"-1.072" (26.4-27.2mm) | 1.076"-1.100" (27.3-27.9mm) | 350900 | 350937-4 | SB5-4 | |
| 1.073"-1.100" (27.3-27.9mm) | 1.101"-1.140" (28.0-29.0mm) | 351000 | 351037-4 | SB6-4 | 7/16-14 M |
| 1.101"-1.138" (28.0-28.9mm) | 1.141"-1.180" (29.0-30.0mm) | 351100 | 351137-6 | SB6-6 | |
| 1.139"-1.178" (28.9-29.9mm) | 1.181"-1.220" (30.0-31.0mm) | 351200 | 351237-6 | SB7-6 | |
| 1.179"-1.206" (29.9-30.6mm) | 1.221"-1.242" (31.0-31.5mm) | 351300 | 351337-6 | SB7-6 | |
| 1.207"-1.230" (30.7-31.2mm) | 1.243"-1.270" (31.6-32.3mm) | 351400 | 351437-6 | SB8-6 | |
| 1.231"-1.256" (31.3-31.9mm) | 1.271"-1.300" (32.3-33.0mm) | 351500 | 351537-6 | SB9-6 | |
| 1.257"-1.290" (31.9-32.8mm) | 1.301"-1.330" (33.0-33.8mm) | 351600 | 351637-6 | SB10-6 | |
| 1.291"-1.321" (32.8-33.6mm) | 1.331"-1.360" (33.8-34.5mm) | 351700 | 351737-6 | SB11-6 | |
| 1.322"-1.370" (33.6-34.8mm) | 1.361"-1.410" (34.6-35.8mm) | 351800 | 351837-6 | SB11-6 | |
| 1.371"-1.400" (34.8-35.6mm) | 1.411"-1.445" (35.8-36.7mm) | 351900 | 351937-6 | SB11-6 | |
| 1.401"-1.450" (35.6-36.8mm) | 1.446"-1.490" (36.7-37.8mm) | 352000 | 352037-6 | SB12-6 | 7/16-14 M |
| 1.451"-1.484" (36.9-37.7mm) | 1.491"-1.525" (37.9-38.7mm) | 352100 | 352137-6 | SB12-6 | |
| 1.485"-1.525" (37.7-38.7mm) | 1.526"-1.570" (38.8-39.9mm) | 352200 | 352237-6 | SB13-6 | |
| 1.526"-1.563" (38.8-39.7mm) | 1.571"-1.600" (39.9-40.6mm) | 352300 | 352337-6 | SB13-6 | |
| 1.564"-1.600" (39.7-40.6mm) | 1.601"-1.640" (40.7-41.7mm) | 352400 | 352437-8 | SB14-8 | |
| 1.601"-1.635" (40.7-41.5mm) | 1.641"-1.680" (41.7-42.7mm) | 352500 | 352537-8 | SB14-8 | |
| 1.636"-1.675" (41.6-42.5mm) | 1.681"-1.700" (42.7-43.2mm) | 352600 | 352637-8 | SB15-8 | |
| 1.676"-1.700" (42.6-43.2mm) | 1.701"-1.725" (43.2-43.8mm) | 352700 | 352737-8 | SB16-8 | |
| 1.701"-1.730" (43.2-43.9mm) | 1.726"-1.772" (43.8-45.0mm) | 352800 | 352837-8 | SB17-8 | |
| 1.731"-1.780" (44.0-45.2mm) | 1.773"-1.820" (45.0-46.2mm) | 352900 | 352937-8 | SB18-8 | |
| 1.781"-1.820" (45.2-46.2mm) | 1.821"-1.865" (46.3-47.4mm) | 353000 | 353037-8 | SB19-8 | 7/16-14 M |
| 1.821"-1.880" (46.3-47.8mm) | 1.860"-1.910" (47.2-48.5mm) | 353100A | 352437-8 | SB19-8 | |
| 1.881"-1.920" (47.8-48.8mm) | 1.911"-1.950" (48.5-49.5mm) | 353200A | 352537-8 | SB20-8 | |
| 1.921"-1.970" (48.8-50.0mm) | 1.951"-2.000" (49.6-50.8mm) | 353300A | 352637-8 | SB20-8 | |
| 1.971"-2.010" (50.1-51.1mm) | 2.001"-2.040" (50.8-51.8mm) | 353400A | 352737-8 | SB16-8 | |
| 2.011"-2.050" (51.1-52.1mm) | 2.041"-2.080" (51.8-52.8mm) | 353500A | 352837-8 | SB18-8 | |
| 2.051"-2.100" (52.1-53.3mm) | 2.081"-2.140" (52.9-54.4mm) | P770A | N774-6 | SB21-6 | |
| 2.101"-2.150" (53.4-54.6mm) | 2.141"-2.180" (54.4-55.4mm) | 353700A | 353037-8 | SB21-8 | |

TURBINE CURVED TUBE CLEANERS



TURBINE STYLE CURVED TUBE CLEANERS

Cleaning Heads

TURBINE CURVED TUBE CLEANERS



Two & Three Arm Heads

Tube Section: Straight or Curved
 Deposit: Medium – Heavy
 Distribution: Uneven
 Cleaner Series: 1100 Series, 1300 Series

| Minimum Tube ID | | Head # | Expansion Range | Spider | Arm | Arm Pin | Short Cutter Pin | Long Arm | Long Cutter Pin | Thread | Cone Cutter |
|-----------------|-------|--------|--------------------------------------|--------|------|---------|------------------|----------|-----------------|-----------|-------------|
| Inch | mm | | | | | | | | | | |
| 1.375 | 34.93 | 250L | 1-1/8" - 1-1/2" (28.58 - 38.10mm) | 251L | 253L | | 255L | 252L | 254L | 7/16-14 F | H35708 |
| 1.750 | 44.45 | L550 | 1-1/2" - 2-3/4" (38.10 - 69.85mm) | K551 | L553 | K556 | L555 | | | 7/16-14 M | |



H2 Head

Tube Section: Straight or Curved
 Deposit: Heavy – Very Heavy
 Distribution: Uneven
 Cleaner Series: 1300 Series, 1100 Series

| Minimum Tube ID | | Head # | Expansion Range | Spider | Arm | Long Arm | Short Cutter Pin | Long Cutter Pin | Cone Cutter | Thread |
|-----------------|--------|--------|--|--------|---------|----------|------------------|-----------------|-------------|------------|
| Inch | mm | | | | | | | | | |
| 2.500 | 63.50 | 316000 | 2.125" - 2.938" (53.98 - 74.61mm) | 316002 | 17743 | 17742 | 17746A | 17746 | T17745 | 5/8-11 M |
| 2.750 | 69.85 | 316100 | 2.500" - 3.188" (63.50 - 80.96mm) | 316102 | 4174 | 16764 | 17048A | 17048 | H36308 | |
| 3.250 | 82.55 | 316300 | 3.0625" - 3.750" (77.79 - 95.25mm) | 316302 | | | | | T17119A | |
| 3.500 | 82.55 | 316400 | 3.188" - 4.500" (80.96 - 114.30mm) | 316402 | 16655 | 16771â | 17050 | 17049 | T16657 | 3/4-10 M |
| 3.750 | 88.90 | 316500 | 3.500" - 4.563" (88.90 - 115.89mm) | 316502 | | | | | | |
| 4.000 | 95.25 | 316600 | 3.750" - 4.813" (95.25 - 122.24mm) | 316602 | | | | | | |
| 4.500 | 101.60 | 316700 | 4.250" - 5.625" (107.95 - 142.88mm) | 316702 | 18039 | | 17050A | 17049A | T16863A | 1-1/8-12 F |
| 5.500 | 114.30 | 316800 | 4.250" - 7.500" (107.95 - 190.5mm) | 316802 | | | | | | |
| 6.500 | 139.70 | 316900 | 5.250" - 8.500" (133.35 - 219.90mm) | 316902 | 317104 | | 317107 | | T16863 | 1-3/8-12 F |
| 8.500 | 165.10 | 317100 | 6.750" - 10.750" (171.45 - 273.05mm) | 317102 | | | | | | |
| 10.000 | 215.90 | 317200 | 7.250" - 12.000" (107.95 - 304.80mm) | 317202 | 304904A | | | | H30708 | 1-5/8-12 F |
| 14.000 | 254.00 | 328000 | 9.000" - 15.500" (228.60 - 393.70mm) | 304902 | | | | | | |
| 18.000 | 355.60 | 328200 | 14.000" - 20.500" (355.60 - 520.70mm) | 305102 | | | | | | |



TURBINE STYLE TUBE CLEANERS

Accessories

Air valves offer an easy way for operators to control the air supply between the hose and turbine motor. Designed for either hand or foot operation.



Air Valve



Foot Valve

| Air Valves | | | | | | | | | |
|-----------------------|-----------------|------------|------------|------------|--------|-----------|----------|----------|------------------|
| Threads | Valve Assembled | Valve Body | Valve Stem | Lock Screw | Handle | "O" Ring | Diameter | Length | Reducer Bushing* |
| 1/8F x 1/8M | 720100 | 720101 | 720102 | 720103 | - | P8309-2 | 31/64" | 1-31/32" | N/A |
| 1/4F x 1/4M | 720200 | 720201 | 720202 | P8302-61 | - | P8309-5 | 45/64" | 1-31/32" | |
| 3/8F x 3/8M | 720300 | 720301 | 720302 | P8302-60 | - | P8309-7 | 63/64" | 2-13/32" | |
| 1/2F x 1/2M | 720400 | 720401 | 720402 | - | 720403 | P8309-7 | 1-5/16" | 1-13/16" | |
| 3/4F x 3/4M | 720500 | 720501 | 720502 | - | 720403 | P8309-9A | 1-19/32" | 1-15/16" | |
| 1F x 1M | 720600 | 720601 | 720602 | - | 720603 | P8309-10A | 1-7/8" | 2-1/4" | |
| Foot Valve | | | | | | | | | |
| 1" NPT F x 1/4" NPT F | 720700B | 720701 | - | - | - | P8309-7 | - | - | 41-50785K85 |
| 1" NPT F x 3/8" NPT F | | | | | | | | | 41-50785K77 |
| 1" NPT F x 1/2" NPT F | | | | | | | | | 41-50785K78 |
| 1" NPT F x 3/4" NPT F | | | | | | | | | 41-50785K79 |
| 1" NPT F x 1" NPT F | | | | | | | | | N/A |

*Required for use of the foot valve



| Flexible Holders | | | |
|---------------------|----------------|----------------|-------------|
| Threads | Shaft Diameter | Approx. Length | Part Number |
| #10-32F x 10-32F | 3/16" | 4" | 420000 |
| #12-24F x 12-24F | | 4-1/8" | 420000BB |
| 5/16-18F x 5/16-18F | | 4-1/4" | 420000CC |
| 5/16-18F x 5/16-18F | 1/4" | 5-1/4" | 420100 |
| 5/16-18F x 3/8-16F | | | 420100BC |
| 3/8-16F x 3/8-16F | 5/16" | 6-1/4" | 420200BB |
| 3/8-16F x 7/16-14F | | | 420200BD |
| 7/16-14F x 7/16-14F | | | 420200DD |
| 7/16-14F x 7/16-14F | 3/8" | 7-1/4" | 420300DD |
| 1/2-13F x 7/16-14F | | | 420300DF |
| 5/8-11F x 5/8-11F | 1/2" | 8" | 420500DD |
| 3/4-10F x 5/8-11F | 5/8" | 9-1/4" | 420600BD |



VENT HOLE CLEANER

Shell & Tube Heat Exchanger

ENSURE OPTIMAL HEAT EXCHANGER PERFORMANCE WITH EFFECTIVE VENT HOLE CLEANING

Maintaining the integrity and efficiency of your heat exchangers is paramount to minimizing downtime and ensuring smooth operations. A critical, yet often overlooked, component in this process is the vent hole. Designed to relieve pressure on the shell side, these seemingly small openings play a vital role in preventing potential failures.

Elliott's new vent hole cleaner is designed to clean hard deposits and navigate challenging 90-degree bends that water jetting just can't touch. This innovative design utilizes a flexible cable, drill head, and coupling, allowing you to simply connect the coupling to a handheld drill and go.



Features & Benefits:

- Superior Deposit Removal: Effectively tackle even the most stubborn deposits that traditional methods like water jetting often leave behind.
- Avoid Costly Failures: Proactive cleaning prevents potential shell-side failures, saving you significant repair costs.
- Reduces Disassembly: Effective cleaning eliminates the need for partial disassembly often required to address issues caused by blocked vent holes.
- Optimizes System Performance: Ensuring clear vent holes contributes to the overall efficient and reliable performance of your heat transfer system.

| Part Number | Vent Hole ID | Vent Hole Length |
|--------------|------------------|------------------|
| VHC500-6000 | 1/2" (12.7mm) | 6" (152.4mm) |
| VHC500-12000 | 1/2" (12.7mm) | 12" (304.8mm) |

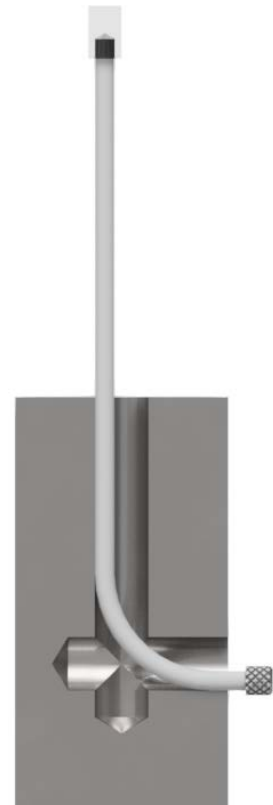

OPERATING HOSES

85 Series

Pipe Thread

- 1/8" to 1-1/4"
- 3.18 to 31.8mm

Elliott's 85 Series Operating Hoses are designed to perform even in the toughest applications. Utilizing the latest manufacturing techniques and materials, these hoses provide the durability and rigidity you need to get the job done.

Standard Operating Hose

Elliott's Standard hose is great for smaller turbine cleaning applications with light to medium deposits.



Standard Operating Hose



Heavy Duty Operating Hose

Heavy Duty Operating Hose

Elliott's Heavy Duty hose is designed to hold up in tougher applications. Made with an internal layer of steel braiding and an abrasion and oil resistant wrap, this hose is ideal for pipe rattling applications, heavy deposits, and large transfer lines.



High Temperature Operating Hose



High Temperature Kevlar Sleeve

High Temperature Operating Hose

Elliott's High Temperature hose is engineered to withstand high heat applications. This innovative design pairs a durable, double-braided hose with an insulating Kevlar sleeve, rated to perform in upwards of 500°F, making it ideal for Aluminum Siphon cleaning.

| Pipe Thread | Max Hose OD | Standard Hose | Heavy Duty Hose | High Temperature Hose* | In-Line Lubricator Kit |
|--------------------|--------------------|---------------|-----------------|------------------------|------------------------|
| 1/8" (3.18mm) | 15/32" (11.9mm) | 85HS012-XX | - | - | 85LK075 |
| 1/4" (6.35mm) | 1/2" (12.7mm) | 85HS025-XX | - | 85HT025-XX | |
| 3/8" (9.56mm) | 11/16" (17.5mm) | 85HS037-XX | - | 85HT037-XX | |
| 1/2" (12.7mm) | 1-1/8" (28.6mm) | - | 85HD050-XX | 85HT050-XX | 85LK100 |
| 3/4" (19.1mm) | 1-1/2" (38.1mm) | - | 85HD075-XX | 85HT075-XX | |
| 1" (25.4mm) | 1-3/4" (44.5mm) | - | 85HD100-XX | 85HT100-XX | |
| 1-1/4" (31.8mm) | 2" (50.8mm) | - | 85HD125-XX | - | |

Replace "XX" with "25" or "50" to indicate 25' or 50' length.
 *High Temperature hoses are available in 10' and 25' lengths.
 Couplings or adapters may be required.



TURBINE STYLE ALUMINUM SIPHON TUBE CLEANERS

ALUMINUM SIPHON CLEANERS

Tube Size

- 2.875" to 4.750" ID
- 73.0mm to 120.65mm ID

Tube Section

- Curved

Type

- Hard powder
- Rock solid

Thickness

- Heavy

Flush

- Dry

Why use boiler cleaning heads when cleaning siphon tubes? Elliott's powerful Turbine Style Motors and Drill Heads offer aggressively fast cleaning and are engineered specifically for aluminum siphon tubes.

Elliott offers a unique Combination Drill Head to clean aggressively reducing cleaning time. Universal Coupling options are available, including welded rivets and Limited Throw, for lasting performance and increased rotor life.

The easy-to-maintain design of Elliott's Turbine Style Tube Cleaner Motors decreases cost and maintenance.

Elliott's Aluminum Siphon Tube Cleaners may be hand operated or machine fed. Contact your local support or Elliott for additional details.



Drill Head



Combination Drill Head

Features & Benefits:

- Optional stellited drills for extended life and cleaning performance.
- Our unique Combination Drill Head cleans siphon tubes aggressively reducing cleaning time.
- Optional Universal Coupling Rivets may be welded for lasting performance.
- Optional Limited Throw Universal Coupling increases the motor's rotor life.
- Design allows for easy change-over of parts and maintenance.

| Motor & Thread | Motor OD | Air Inlet | Coupling & Thread | Drill Head | Drill Head OD | Combination Drill Head | Combination Drill Head OD | Operating Hose | | |
|--------------------------|---------------------|-----------|----------------------|-------------|---------------------|------------------------|---------------------------|----------------|--------------------|------------|
| 136400D2375 3/4"-10 | 2.375" (60.33mm) | 3/4" NPT | L28000 5/8"-11 | H2356-625S | 2.250" (57.15mm) | 78H | 2.500" (63.5mm) | 85HT075-XX | | |
| | | | L28000A 3/4"-10 | H2356-750S | | 78HS2 | | | | |
| ET4325K 3/4"-16 | 2.562" (65.07mm) | | L57700C 5/8"-11 | - | - | 78H | | | | |
| | | | L27700D 3/4"-10 | H2404-750S | 2.625" (66.68mm) | 78HS2 | | | | |
| 134200D2625 3/4"-10 | 2.625" (66.68mm) | | L27700 3/4"-10 | | | | | | | |
| ET4350K 7/8"-14 | 2.812" (71.42mm) | | L37300F 3/4"-10 | H2355-750S | 2.875" (73.03mm) | | | | | |
| 132500D3000 7/8"-9 | 3.000" (76.2mm) | | L37300 3/4"-10 | - | - | 78ES1 | | | 3.000" (76.2mm) | 85HT100-XX |
| | | | L44800A 1-1/8"-12 | H2509-1125S | 3.500" (88.9mm) | | | | | |
| | | | L44800 1-1/8"-12 | | | | | | | |
| 139900D3625 1-1/8"-12 | 3.625" (92.08mm) | | | | | | | | | |

Replace "XX" with "10" or "25" to indicate 10' or 25' length.

For welded pin u-joints add an "ST" to the end of the coupling part number

Couplings or adapters may be required.



GAS LINE RENEWAL

Pipe Size

- 0.750" to 1.500"
- 19.05mm to 38.10mm

Tube Section

- Straight

Type

- Soft, gummy or organic
- Hard powder

Thickness

- Light
- Medium

Flush

- Dry

The air turbine style motor design provides an immediate and powerful startup to drive the cleaning head down the tube at a high speed, removing light to medium deposits of scale, mud, and other process residues.

Features & Benefits:

- Powerful multi vane motors for fast start up.
- Cone shape cutter design for optimum pipe cleaning.
- Reinforced operating hose for longer service life.
- Bearing-less design makes it easy to service, with no special tools required.
- Metal vanes for motor durability and prolonged tool life.
- Optional air valves allow you to turn off supply near the motor, making it a one man operation.

Spares & Accessories:

- 6055 Lubricator
- Operating Hose, *see table below or page 147*
- Air Valve, *see table below or page 145*
- Foot Valve, *see page 145*

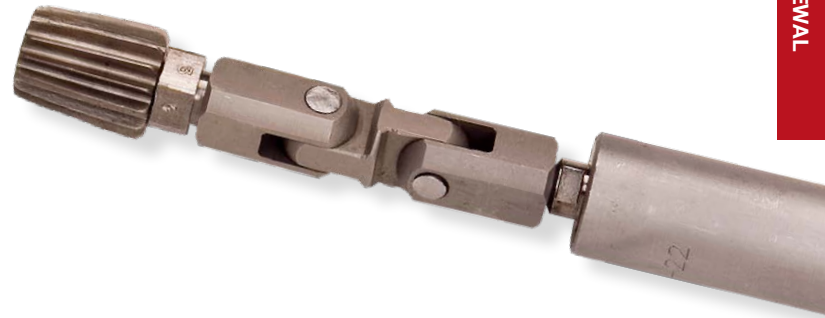

“ Elliott’s Gas Line Cleaners are phenomenal. They have a long tool life and are easy to rebuild - my guys love them!

Richard Rizzardi
Manager Gas Operations, Miller Bros

| Gas Line Renewal Kits | | | | | | | |
|-----------------------|-------|------------|------------|-----------|-------------|----------------|-----------|
| Pipe Size | | Kit Number | Motor | Universal | Cutter Head | Operating Hose | Air Valve |
| Inch | mm | | | | | | |
| 0.750" | 19.05 | 75SP | D67000-18 | L69100A | 478D | 85HS012-XX | 720100 |
| 1.000" | 25.40 | 100SP | D67300-28M | L69400 | 319000M | 85HS037-XX | 720300 |
| 1.250" | 31.75 | 125SP | D67500-36 | L51100 | 313500S | | |
| 1.500" | 38.10 | 150SP | D67800-46 | L76200A | 313600S | 85HD050-XX | 720400 |

*Kits include 1 motor, universal, cutter head, and a motor shaft wrench.
Replace "XX" with "25" or "50" to indicate 25' or 50' length.
Couplings or adapters may be required.*



PIPE RATTLING EQUIPMENT

Oil Field Pipeyard Cleaning Motors & Heads

PIPE RATTLING EQUIPMENT

Tube Size

- 2.375" to 20.000" OD
- 60.3mm to 508.0mm OD

Tube Section

- Straight

Type

- Hard powder
- Rock solid

Thickness

- Medium
- Heavy

Flush

- Dry

These product kits have been specially designed for the oil field. They are recommended for the most common sizes used in the oil field today.

Rattling equipment for oil field tubular products are ideal for 2.375" to 20.000" OD (60.3mm to 508.0mm). Additional sizes and configurations are available upon request.

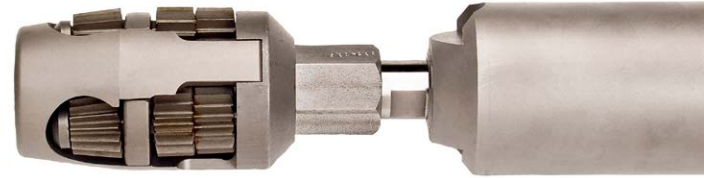

Features & Benefits:

- Powerful motors for fast cleaning.
- Engineered design that is easy to maintain.
- Armored hose design for rigidity and torque absorption.

Rattling Equipment Kit Includes:

- Air Motor
- Motor Sleeve (where applicable)
- Wrench
- Cutter Head
- Head Coupling
- 2 Sets of replacement cutters
- 2 Sets of replacement cutter pins

Spares & Accessories:

- Operating Hose: Highly recommended for proper operation and long life.
- 6070 Lubricator: Highly recommended for proper operation and long life.
- Foot Valve
- Replacement Cutters, Cutter Pins, & Arms
- Motor Paddles & Rotors

| Rattling Equipment Kits | | | Rattling Equipment Accessories | |
|---------------------------------|-----------------|-------------|--------------------------------|------------|
| Outside Diameter Pipe or Casing | | Part Number | Operating Hose | Foot Valve |
| 2.375" | 60.3mm | 20308K | 85HD075-XX | 720700B |
| 2.875" | 73.0mm | 20708K | | |
| 3.500" | 88.9mm | 30102K | 85HD100-XX | |
| 4.500" | 114.3mm | 40102K* | | |
| 5.000" - 5.500" | 127.0 - 139.7mm | 50000K | | |
| 7.000" | 177.8mm | 70000K* | | |
| 7.625" | 193.7mm | 70508K* | | |
| 8.625" | 219.1mm | 80508K* | | |
| 9.625" | 244.5mm | 90508K* | 85HD125-XX | |
| 10.750" | 273.1mm | 100304K* | | |
| 11.750" | 298.5mm | 110304K* | | |
| 13.375" | 339.7mm | 130308K* | | |
| 20.000" | 508.0mm | 200000K* | | - |

*Kit also includes Motor Sleeve.

Replace "XX" with "25" or "50" to indicate 25' or 50' length.

Couplings or adapters may be required.



Pipe Size

- 3/4" to 5-7/8" OD
- 19.05mm to 149.23mm OD

Tube Section

- Straight

Type

- Hard powder
- Rock solid

Thickness

- Medium
- Heavy

Flush

- Dry

The ET Series cleaning motors and heads are designed and tested using advanced engineering practices to confidently withstand tough cleaning applications and provide long tool life. The powerful motor combined with the cleaning head provide superior cleaning performance for oil field pipes and tubular products.

The ET Series offers a wide selection of cutters and cleaning heads for 7/8" to 4-3/4" (22.225 to 120.65mm) tubes ranging from single head cutters to spring loaded swing arm. Additional sizes and configurations are available upon request.

Features & Benefits:

- The most advanced engineering and manufacturing principles for powerful performance and superior cleaning.
- Thoroughly tested, wear-resistant design for the longest tool life in the industry.
- Gearless design for easy maintenance.

Spares & Accessories:

- Replacement Cutters, Cutter Pins, & Arms
- Motor Paddles & Rotors
- Operating Hose
- Air Valve (see page 145)
- Foot Valve (see page 145)
- 6070 Filter/Lubricator

* Used in hand cleaning operations

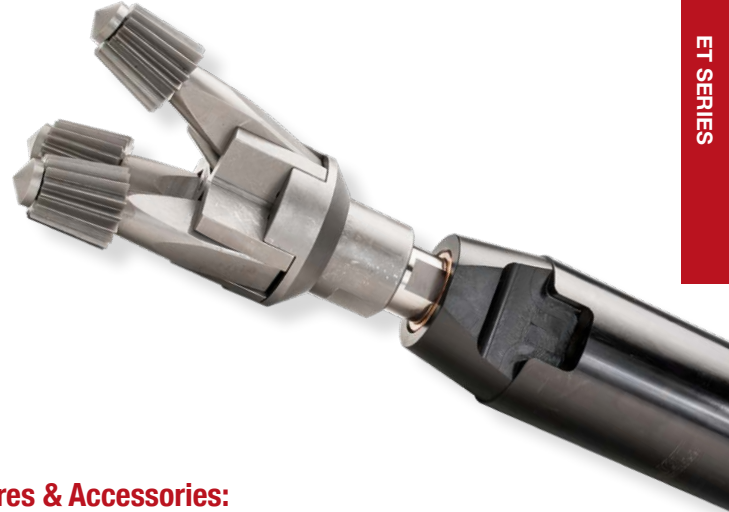

ET SERIES

Oil Field Pipeyard Cleaning Motors & Heads

Tube Internal Diameter (ID)

Is a result of the OD and the wall thickness.

Drift Diameter

Is the diameter of a 42" long mandrel that passes through the tubing joint. It is a foremost parameter as it gives the maximum OD of any equipment to run through the tubing string and accounts for roundness of a pipe.

Drill Pipe

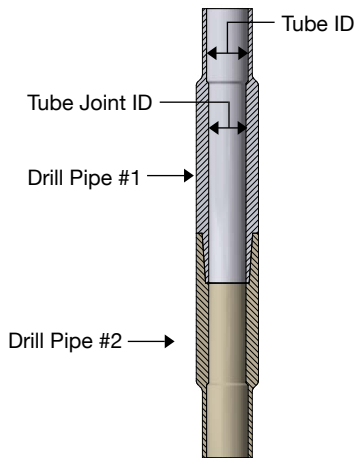

Single Pin Head



ETTC Head



ETP Head

Tubing Pipe Recommendation Chart

| Size | Weight | Drift | Connection | Head | Motor | Operating Hose |
|---------|--------|--------|--------------|----------|-----------|----------------|
| 3/4" | 1.50# | .648" | 3/4"CS | D6701840 | D67000-18 | 85HS012-XX |
| 1" | 2.25# | .848" | 1"CS | ET2940 | ET29A | 85HS025-XX |
| 1-1/4" | 3.02# | 1.184" | 1-1/4"CS | ET12240 | ET31 | 85HS037-XX |
| 1-1/2" | 3.64# | 1.406" | 1-1/2"CS | ETTC14 | ET3150 | 85HD050-XX |
| 2-1/16" | 3.25# | 1.657" | 2-1/16"CS | ETTC11 | ET3162 | 85HD075-XX |
| 2-1/16" | 3.25# | 1.657" | 2-1/16"GST | ETTC11 | ET3162 | 85HD075-XX |
| 2-3/8" | 4.70# | 1.901" | 2-3/8"CS | ETTC16PY | ET3200 | 85HD075-XX |
| 2-3/8" | 4.70# | 1.901" | 2-3/8"EUE8rd | ETTC16PY | ET3200 | 85HD075-XX |
| 2-3/8" | 5.95# | 1.773" | 2-3/8"PH6 | ETTC17PY | ET3178 | 85HD075-XX |
| 2-7/8" | 6.50# | 2.347" | 2-7/8"CS | ETP9PY* | ET3250* | 85HD100-XX |
| 2-7/8" | 6.50# | 2.347" | 2-7/8"EUE8rd | ETP9PY* | ET3250* | 85HD100-XX |
| 2-7/8" | 7.90# | 2.229" | 2-7/8"PH6 | ETP15PY | ET3225 | 85HD075-XX |
| 3-1/2" | 9.30# | 2.867" | 3-1/2"CS | ETP6APY | ET3275 | 85HD100-XX |
| 3-1/2" | 10.30# | 2.797" | 3-1/2"CS | ETP6APY | ET3275 | 85HD100-XX |
| 3-1/2" | 9.30# | 2.867" | 3-1/2"EUE8rd | ETP6APY | ET3275 | 85HD100-XX |
| 3-1/2" | 12.95# | 2.625" | 3-1/2"PH6 | ETP7SPY | ET3275 | 85HD100-XX |
| 4-1/2" | 12.75# | 3.833" | 4-1/2"CS | ETP3SPY | ET3350 | 85HD100-XX |
| 4-1/2" | 12.60# | 3.833" | 4-1/2"LT&C | ETP3SPY | ET3350 | 85HD100-XX |
| 4-1/2" | 12.75# | 3.833" | 4-1/2"EUE8rd | ETP3SPY | ET3350 | 85HD100-XX |
| 4-1/2" | 15.50# | 3.701" | 4-1/2"PH6 | ETP3SPY | ET3350 | 85HD100-XX |
| 4-1/2" | 19.20# | 3.515" | 4-1/2"PH6 | ETP4SPY | ET3350 | 85HD100-XX |

* Alternative Head & Motor: ETP15PY and ET3225

Replace "XX" with "25" or "50" to indicate 25' or 50' length.

Couplings or adapters may be required.

Tubing Pipe

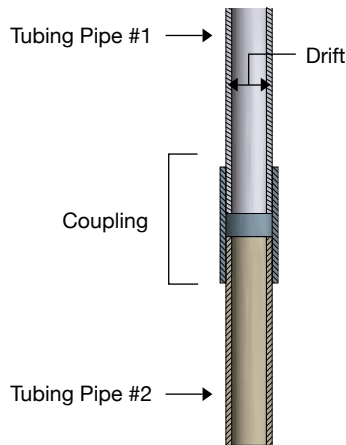

Oil Field Pipeyard Cleaning Motors & Heads



Spring Head



Swing Head

Drill Pipe Recommendation Chart

| Size | Weight | Tube Joint ID | Tube ID | Connection | Spring Head | Swing Arm Head | Motor | Operating Hose |
|--------|--------|---------------|---------|-----------------|-------------|----------------|--------|----------------|
| 2-3/8" | 6.65# | 1.750" | 1.815" | 2-3/8"IF/NC26 | - | ET1840 | ET3178 | 85HD075-XX |
| 2-7/8" | 10.40# | 1.500" | 2.151" | 2-7/8" HTPAC | ETSRA1470 | ET1470 | ET3150 | 85HD050-XX |
| 2-7/8" | 10.40# | 1.500" | 2.151" | NC26 2-3/8 IFSH | ETSRA1470 | ET1470 | ET3150 | 85HD050-XX |
| 2-7/8" | 10.40# | 1.750" | 2.151" | HT-26 | ETSRA1470 | ET1470 | ET3150 | 85HD050-XX |
| 2-7/8" | 10.40# | 1.975" | 2.151" | 2-3/8HTSLH90 | ETTC13PY* | | ET3200 | 85HD075-XX |
| 2-7/8" | 10.40# | 2.000" | 2.151" | 2-7/8"IF NC31 | ETTC13PY* | | ET3200 | 85HD075-XX |
| 2-7/8" | 10.40# | 2.125" | 2.151" | 2-7/8"IF NC31 | ETTC13PY* | | ET3200 | 85HD075-XX |
| 2-7/8" | 10.40# | 2.156" | 2.151" | 2-7/8"A0H | ETTC13PY* | | ET3200 | 85HD075-XX |
| 3-1/2" | 13.30# | 2.563" | 2.602" | XT-38 | ETSL3370A | ET3370A | ET3250 | 85HD100-XX |
| 3-1/2" | 13.30# | 2.563" | 2.764" | 3-1/2"IF NC38 | ETSL3370A | ET3370A | ET3250 | 85HD100-XX |
| 3-1/2" | 13.30# | 2.563" | 2.764" | 3-1/2"HT-38 | ETSL3370A | ET3370A | ET3250 | 85HD100-XX |
| 3-1/2" | 13.30# | 2.563" | 2.764" | 3-1/2"XT-38 | ETSL3370A | ET3370A | ET3250 | 85HD100-XX |
| 3-1/2" | 13.30# | 2.688" | 2.764" | 3-1/2"IF NC38 | ETSL3370A | ET3370A | ET3250 | 85HD100-XX |
| 3-1/2" | 15.50# | 2.563" | 2.602" | 3-1/2"IF NC38 | ETSL3370A | ET3370A | ET3250 | 85HD100-XX |
| 3-1/2" | 15.50# | 2.563" | 2.602" | NC-38 | ETSL3370A | ET3370A | ET3250 | 85HD100-XX |
| 4" | 14.00# | 2.688" | 3.340" | XT-39 | ETSL3270ALA | ET3270ALA | ET3250 | 85HD100-XX |
| 4" | 14.00# | 2.688" | 3.340" | 4" FH NC40' | ETSL3270ALA | ET3270ALA | ET3250 | 85HD100-XX |
| 4" | 14.00# | 2.688" | 3.340" | HT-40 | ETSL3270ALA | ET3270ALA | ET3250 | 85HD100-XX |
| 4" | 14.00# | 2.688" | 3.340" | XT-M 38 | ETSL3270ALA | ET3270ALA | ET3250 | 85HD100-XX |
| 4" | 14.00# | 2.813" | 3.340" | XT-39 | ETSL3270ALA | ET3270ALA | ET3250 | 85HD100-XX |
| 4" | 15.70# | 2.688" | 3.340" | XT-39 | ETSL3270ALA | ET3270ALA | ET3250 | 85HD100-XX |
| 4-1/2" | 16.60# | 3.000" | 3.826" | 4-1/2"XH NC46 | ETSL970LA | ET970LA | ET3275 | 85HD100-XX |
| 4-1/2" | 20.00# | 3.000" | 3.640" | 4-1/2"XH NC46 | ETSL970LA | ET970LA | ET3275 | 85HD100-XX |
| 5" | 19.50# | 3.250" | 4.276" | 4-1/2"IF NC50 | ETSL770SA | ET770SA | ET3275 | 85HD100-XX |
| 5" | 19.50# | 3.750" | 4.276" | XT-50 | ETSL770SA | ET770SA | ET3275 | 85HD100-XX |
| 5" | 25.60# | 3.250" | 4.000" | 4-1/2"IF NC50 | ETSL770SA | ET770SA | ET3275 | 85HD100-XX |
| 5-1/2" | 21.90# | 3.500" | 4.778" | 5-1/2" FH | ETSL770SA | ET770SA | ET3275 | 85HD100-XX |
| 5-1/2" | 24.70# | 3.000" | 4.670" | 5-1/2" FH | ETSL770SA | ET770SA | ET3275 | 85HD100-XX |
| 5-7/8" | 23.40# | 4.250" | 5.153" | XT-57 | ETSL770SA | ET770SA | ET3275 | 85HD100-XX |
| 5-7/8" | 26.30# | 4.250" | 5.045" | XT-57 | ETSL770SA | ET770SA | ET3275 | 85HD100-XX |
| 5-7/8" | 28.70# | 4.250" | 4.875" | CTM57 | ETSL770SA | ET770SA | ET3275 | 85HD100-XX |

* Will be supplied with a barrel style cleaning head
 Replace "XX" with "25" or "50" to indicate 25' or 50' length.
 Couplings or adapters may be required.



TESTS

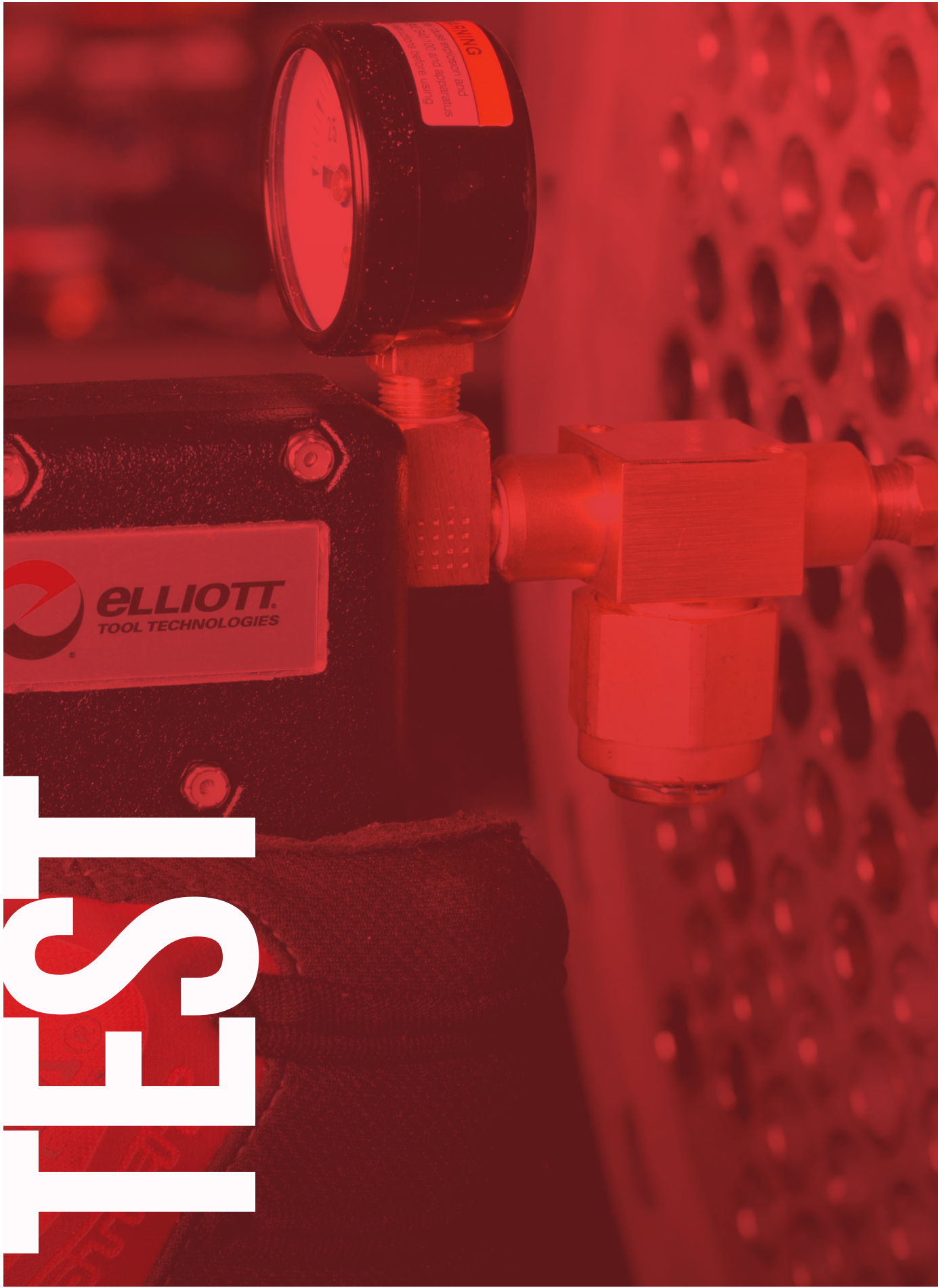

WARNING
Use proper pressure and temperature
before using

 **ELLIOTT.**
TOOL TECHNOLOGIES

CONTENTS

| | |
|--|------------|
| RECON Series Tube Leak Test Guns | 154 |
| RECON 1250 & 2500 - Pressure | 154 |
| RECON 1500 - Vacuum..... | 162 |

RECON SERIES TUBE LEAK TEST GUNS

RECON 1250 & 2500 - Pressure

RECON PRESSURE TEST GUNS

Tube Size

- 0.500" to 2.500" OD
- 12.7mm to 63.5mm OD

INTELLIGENTLY DESIGNED AND BATTLE TESTED FOR IMPOSSIBLE MISSIONS.

Take on the mission of quickly and easily finding tube leaks. Utilize the RECON Series tube leak test guns and test every tube quickly and efficiently with the most ergonomic test gun on the market.

From the lightweight cast aluminum body to the ergonomically modeled pistol grip, each feature offers an engineered and rugged solution for finding leaking tubes.

The RECON 1250 and 2500 are simple to operate. Connect the air supply, insert the seals into both sides of the tube ends and pressurize the tubes. Then monitor the gauges for drops in air pressure, which indicate a tube leak.



RECON 1250

RECON 1250 Kit (TTP1250) includes:

- Tube Leak Test Gun Set
- 3 Support Tube Assemblies (TTPST1, TTPST2, TTPST3)
- Pressure Regulator
- Tool Case

RECON 2500 Kit (TTP2500) includes:

- Tube Leak Test Gun Set
- 2 Support Tube Assemblies (TTPST4)
- Washers to support up to 2.5" seal sets.
- Tool Case

Spares & Accessories:

- Seal & Washer Sets: Seals are compatible with Elliott's 5373 Series Test Gun. **See table on page 158.**
- Seal Kits: Includes all of the seal sets to cover the entire range of the gun. Available for both the RECON 1250 and 2500 Test Guns. **See table below.**
- Support Tubes & Support Tube Extensions: Make finding leaks easier on channel head and water box applications. Support tubes are compatible with Elliott's 5373 Series Test Gun. **See table on page 158.**

| Tube OD Range | Tube Leak Test Gun Kit* | Seal Kit |
|---|-------------------------|-----------|
| 1/2" x 12 BWG - 1-1/4" x 15 BWG (12.7mm x 2.77 Wall - 34.9mm x 1.83 Wall) | zTTP1250 | TTP1250SK |
| 1-1/4" x 16 BWG - 2-1/2" x 24 BWG (31.75mm x 1.85 Wall - 63.5mm x 0.56 Wall) | TTP2500 | TTP2500SK |

*Seal Sets are ordered separately.



RECON SERIES TUBE LEAK TEST GUNS

RECON 1250 & 2500 - Pressure



Easy to hold and use with superior grip ergonomics.



Steel gauge body to protect the gauge.



Use in tight workspaces because of its thin profile.

Safe & Ergonomic

Superior Grip

Easy to hold and use with superior grip ergonomics, utilizing a non-slip, wrinkle-coat finish on the handle.

Works Great In Small Spaces

Easy to use in tight work spaces because of its thin profile.

Built-In Safety Features

Ensure safety with a bleed off valve to release pressure and a moving piston positioned away from the operator.

Operator Friendly

Reduce operator fatigue and increase efficiency with the lightweight aluminum body.

Increased Productivity

Easy To Use

Simply connect the air supply, insert the seals into both sides of the tube ends, pull the trigger to pressurize the tube, and monitor.

Increase Accuracy

Increase accuracy using the dual gauge design to read pressure from both tube ends.

Long Tool Life

Durable cast aluminum body that protects the working components and a steel gauge body to protect the gauge.

Specifications:

RECON 1250 & 2500 Air Requirements:

- Minimum - 40 PSI (2.7 bar)
- Maximum - 125 PSI (8.5 bar)



RECON 2500



RECON SERIES TUBE LEAK TEST GUNS

RECON 1250 & 2500 - Pressure

RECON PRESSURE TEST GUNS

| RECON 1250 & 2500 Seal Sets | | | | | | | |
|-----------------------------|----------|----------|----------|----------|----------|----------|----------|
| Tube OD | BWG | | | | | | |
| | 8-9 | 10-11 | 12-13 | 14-15 | 16-17 | 18-19 | 20-24 |
| 1/2" (12.7mm) | - | - | TTPS250 | TTPS300 | TTPS340 | TTPS370 | TTPS400 |
| 5/8" (15.9mm) | TTPS270 | TTPS340 | TTPS370 | TTPS440 | TTPS470 | TTPS500 | TTPS530 |
| 3/4" (19.1mm) | TTPS400 | TTPS440 | TTPS500 | TTPS530 | TTPS590 | TTPS620 | TTPS650 |
| 7/8" (22.2mm) | TTPS530 | TTPS590 | TTPS620 | TTPS690 | TTPS720 | TTPS750 | TTPS780 |
| 1" (25.4mm) | TTPS650 | TTPS690 | TTPS750 | TTPS800 | TTPS840 | TTPS870 | TTPS900 |
| 1-1/8" (28.6mm) | TTPS780 | TTPS840 | TTPS870 | TTPS940 | TTPS970 | TTPS1000 | TTPS1030 |
| 1-1/4" (31.75mm) | TTPS900 | TTPS940 | TTPS1000 | TTPS1070 | TTPS1090 | TTPS1120 | TTPS1150 |
| 1-3/8" (34.9mm) | TTPS1050 | TTPS1090 | TTPS1120 | TTPS1190 | TTPS1230 | TTPS1250 | TTPS1280 |
| 1-1/2" (38.1mm) | TTPS1150 | TTPS1190 | TTPS1250 | TTPS1310 | TTPS1340 | TTPS1370 | TTPS1400 |
| 1-5/8" (41.3mm) | TTPS1280 | TTPS1340 | TTPS1370 | TTPS1440 | TTPS1470 | TTPS1500 | TTPS1530 |
| 1-3/4" (44.5mm) | TTPS1400 | TTPS1470 | TTPS1500 | TTPS1550 | TTPS1590 | TTPS1620 | TTPS1650 |
| 2" (50.8mm) | TTPS1650 | TTPS1700 | TTPS1750 | TTPS1800 | TTPS1840 | TTPS1840 | TTPS1900 |
| 2-1/4" (34.9mm) | TTPS1900 | TTPS1950 | TTPS2000 | TTPS2050 | TTPS2090 | TTPS2120 | TTPS2150 |
| 2-1/2" (63.5mm) | TTPS2150 | TTPS2200 | TTPS2250 | TTPS2290 | TTPS2340 | TTPS2370 | TTPS2400 |

Seal sets contain two seals and four washers. Seal sets TTPS250 through TTPS440 contain 4 seals and 4 washers. Standard seal material is neoprene. Seals are backwards-compatible.

| Replacement Support Tube Sets & Optional Extensions | | | | | |
|---|----------------------------------|--------------------------|--------------------------|--------------------------|----------------------------|
| Seal Set Size | 4" (Std.) (101.6mm) Part # | 12" (305mm) Part # | 24" (610mm) Part # | 36" (914mm) Part # | 48" (1,219mm) Part # |
| TTPS250 - TTPS440 | TTPST1 | TTPST1-12 | TTPST1-24 | TTPST1-36 | TTPST1-48 |
| TTPS470 - TTPS800 | TTPST2 | TTPST2-12 | TTPST2-24 | TTPST2-36 | TTPST2-48 |
| TTPS840 - TTPS1190 | TTPST3 | TTPST3-12 | TTPST3-24 | TTPST3-36 | TTPST3-48 |
| TTPS1230 - TTPS1590 | TTPST4 | TTPST4-12 | TTPST4-24 | TTPST4-36 | TTPST4-48 |
| TTPS1620 - TTPS2000 | TTPST5 | TTPST5-12 | TTPST5-24 | TTPST5-36 | TTPST5-48 |
| TTPS2050 - TTPS2400 | TTPST6 | - | - | - | - |

For larger seal and washer sizes, contact factory. Support Tubes are backwards-compatible. Extensions for TTPST6 available upon request.





A FASTER & SAFER WAY TO PULL TUBES

ELLIOTT'S SUPER COLLET TUBE PULLER



Built-In Pump Control



Eye-bolts for connecting to a counterbalance



Operator Safety Deflector

Key Features

Powerful Grip – Up to 25 tons of pulling capacity with proven spear-style teeth.

Save Machine Time – Pull tube stubs fast—no machining or knockout needed.

Protects Tube Sheets – Eliminates damage from drilling or knockout tools.

No Spears Needed – Single-step operation reduces cost and time.

Safe & Simple – Integrated pump control, eye bolts, and deflector shield keep operators protected.

Pulling Capacity: Up to 25 tons

Tube Range: ½" – 2½" OD

Power: Electric or Pneumatic Hydraulic Pump

Heads Available: 2



Learn more on [page 202](#) or at elliott-tool.com

WHEN HEAT EXCHANGERS FALTER

UNDERSTANDING TUBE FAILURE MECHANISMS

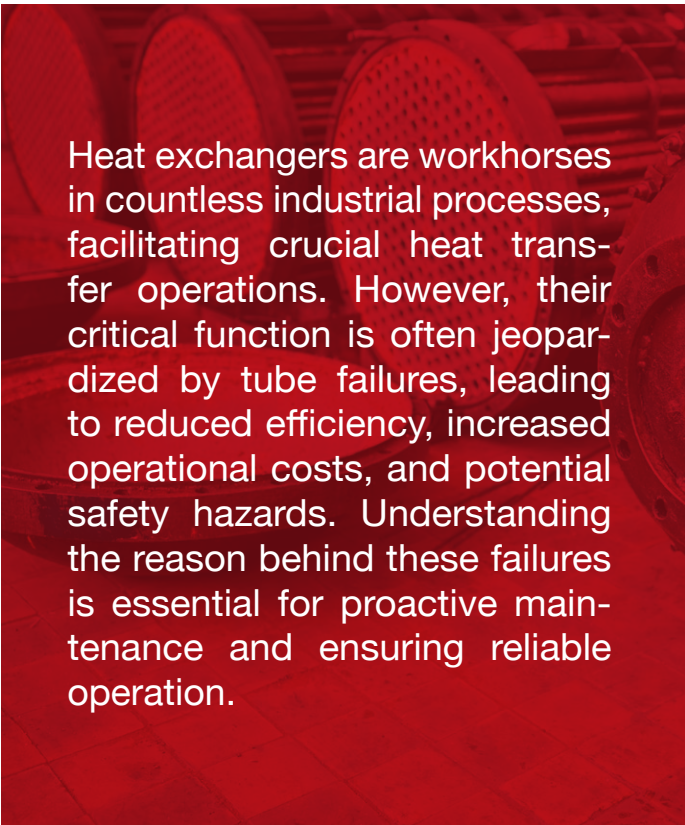

Heat exchangers are workhorses in countless industrial processes, facilitating crucial heat transfer operations. However, their critical function is often jeopardized by tube failures, leading to reduced efficiency, increased operational costs, and potential safety hazards. Understanding the reason behind these failures is essential for proactive maintenance and ensuring reliable operation.

THERMAL FATIGUE & CRACKING

Heat exchangers are constantly subjected to dynamic thermal environments. During operation, startup, and shutdown, the materials within the heat exchanger experience continuous temperature fluctuations. These temperature differences cause the material to repeatedly expand and contract. Over time, this cyclical thermal stress can lead to the formation and propagation of microscopic cracks, a phenomenon known as thermal fatigue. These cracks are particularly prevalent in areas with significant temperature gradients or constraints, such as U-bends or where tubes are welded to tube sheets. Eventually, these cracks can grow into larger fissures, compromising the tube's integrity and leading to leaks.

Detection Methods for Thermal Fatigue:

Identifying thermal fatigue early is crucial to prevent catastrophic failure. Visual inspection is a primary method, looking for visible cracks or discoloration, especially at stress concentration points. Dye penetrant inspection (DPI) or magnetic particle testing (MPT) can reveal surface cracks that are not readily visible to the naked eye. For sub-surface crack detection, ultrasonic testing (UT) can be employed. Furthermore, monitoring operational parameters like temperature cycling rates can help predict potential areas of concern.

TUBE LEAKS



Tube leaks, a common and problematic issue, often manifest as a result of various underlying causes. These can include the formation of cracks or holes in the tube surface due to deposit build-up, which creates localized corrosive environments. Similarly, general corrosion, erosion from high fluid velocities and abrasive particles, or even improper cleaning methods can thin the tube wall, making it susceptible to leaks. Once a leak forms, it can significantly impact heat exchanger efficiency as fluids bypass the intended heat transfer path. More critically, if fluids from different streams mix, it can lead to dangerous reactions or contamination, posing a significant safety risk.

Beyond operational factors, manufacturing and installation errors also contribute significantly to tube leaks. Under-rolling during fabrication occurs when the tube is not expanded sufficiently into the tube sheet hole. This creates a potential leak path between the tube's outer diameter (OD) and the tube sheet hole's inner diameter (ID). Conversely, over-rolling happens when the tube is expanded beyond the required wall reduction. This can severely damage the tube sheet or adjacent tubes. When a tube sheet "ligament" (the mate-

rial between adjacent tube holes) is over-rolled, it can deform the ligaments of surrounding joints, inducing stress and causing them to leak. Such widespread deformation drastically increases the entire tube sheet's susceptibility to leaks, leading to higher repair costs and persistent efficiency drops.

Detection Methods for Tube Leaks:

Several methods are used to pinpoint tube leaks. Pressure or vacuum testing is an easy hand held method that can be used to identify a drop in pressure or leak in a tube. Helium leak detection is a highly sensitive method where helium gas is introduced to one side, and a detector on the other side identifies escaping helium. Lastly, hydro testing is a common method used after fabrication where a vessel is filled with water under pressure and monitored for any leaking joints.

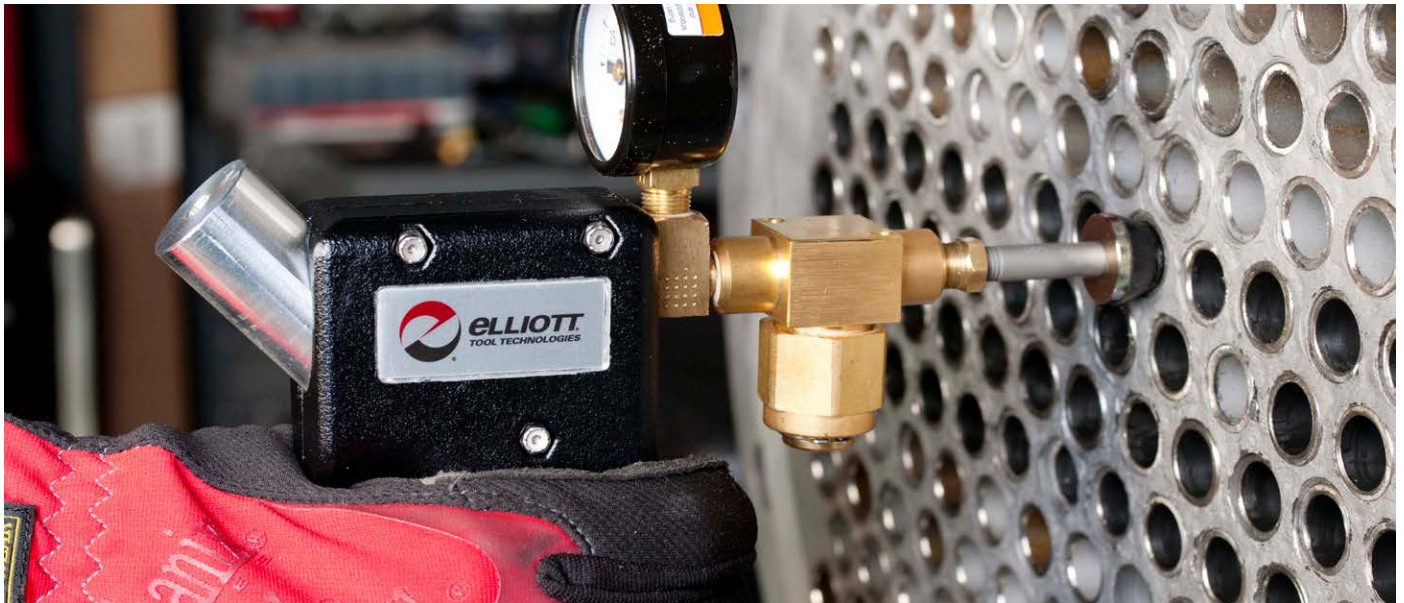

MECHANICAL FAILURE

Mechanical failure in heat exchanger tubes is a broad category driven by factors such as vibration, improper installation, and operational stress.

Excessive vibration is a pervasive culprit. Flow-induced vibration, stemming from the interaction between fluid flow and tubes, can lead to tube wear and fatigue failure. Tube wear occurs when tubes repeatedly rub against support structures like baffles or even against adjacent tubes. This constant friction gradually erodes the tube material, leading to thinning and eventual perforation.

Fatigue failure, on the other hand, results from the continuous cyclic stress imposed by vibration. Even if individual stress levels

are below the material's yield strength, prolonged exposure can initiate and propagate fatigue cracks, particularly at stress concentration points like U-bends or areas with sharp geometric changes. If these cracks are not identified and addressed early, they can rapidly grow, culminating in catastrophic tube ruptures.

Beyond vibration, improper design or installation can create inherent weaknesses. Incorrect material selection, inadequate support structures, or tube-to-tubesheet joint issues during fabrication can all lead to "weak points" susceptible to premature wear or even sudden, catastrophic failure under normal operating conditions.

Detection Methods for Mechanical Failure: Visual inspection can reveal signs of rubbing or deformation. Eddy current testing (ECT) is highly effective for detecting fatigue cracks, thinning, and pitting in

non-ferromagnetic tubes. Remote visual inspection (RVI) using borescopes allows for internal examination of tubes. Vibration analysis and modal analysis can identify resonant frequencies and predict potential vibration issues. For larger-scale issues, hydrostatic testing can reveal gross mechanical failures by subjecting the entire vessel to high pressure.

By understanding these distinct failure mechanisms and employing appropriate detection methods, industries can significantly improve the reliability and lifespan of their critical heat exchange equipment, safeguarding both efficiency and safety.

RECON SERIES TUBE LEAK TEST GUNS

RECON 1500 - Vacuum

Tube Size

- 0.280" to 2.456" ID
- 7.1mm to 62.4mm ID

INTELLIGENTLY DESIGNED AND BATTLE TESTED FOR IMPOSSIBLE MISSIONS.

Take on the mission of quickly and easily finding tube leaks. Utilize the RECON Series tube leak test guns and test every tube quickly and efficiently with the most ergonomic test gun on the market.

From the lightweight cast aluminum body to the ergonomically modeled pistol grip, each feature offers an engineered and rugged solution for finding leaking tubes.

Operating the RECON 1500 Tube Leak Test Gun is simple. With the air supply connected, plug one tube end with the test gun and the other end with the T-Handle Plugging Tool. Press the lever trigger and the Venturi System quickly and efficiently evacuates the tube. Then monitor the gauge for loss of vacuum, which indicates a tube leak.

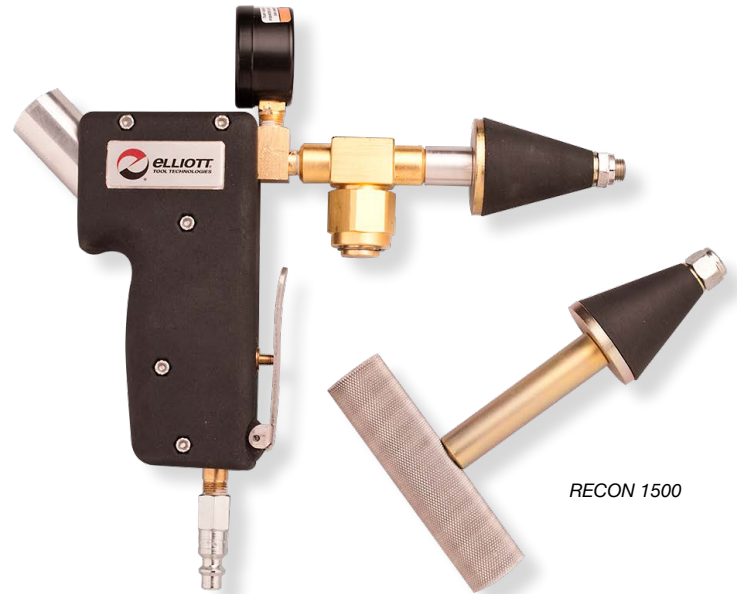

RECON 1500

| Tube ID Range | Tube Leak Test Gun Kit | Seal & Washer Set Part Number |
|--------------------------------|------------------------|-------------------------------|
| 0.280"-0.690" (7.1-17.5mm) | TTV1500a | TTVS1 |
| 0.640"-1.450" (16.2-36.8mm) | | TTVS2 |
| 1.490"-2.456" (37.8-62.4mm) | | TTVS3 |

| Support Tube Extensions | | | | |
|--------------------------------|--------------------------|--------------------------|--------------------------|----------------------------|
| Tube ID Range | 12" (305mm) Part # | 24" (610mm) Part # | 36" (914mm) Part # | 48" (1,219mm) Part # |
| 0.280"-0.690" (7.1-17.5mm) | TTVST1-12 | TTVST1-24 | TTVST1-36 | TTVST1-48 |
| 0.640"-1.450" (16.2-36.8mm) | TTVST2-12 | TTVST2-24 | TTVST2-36 | TTVST2-48 |
| 1.490"-2.456" (37.8-62.4mm) | TTVST3-12 | TTVST3-24 | TTVST3-36 | TTVST3-48 |

RECON 1500 Kit includes:

- Tube Leak Test Gun
- T-Handle Plugging Tool
- 2 Seal & Washer Sets (TTVS1, TTVS2)
- Tool Case

Spares & Accessories:

- Seal & Washer Sets: TTVST3 and TTVS3 are available to accommodate larger tube sizes. TTVST3 includes a seal and washer set for the Support Tube and T-Handle Plugging Tool.
See table to the left.
- Support Tube Extensions: Make finding leaks easier on channel head and water box applications. Available in lengths of 12", 24", 36" and 48". Support Tubes are compatible with Elliott's 5556 Series Test Gun. *See table to the left.*
- Filter Element (TTV1500FE)



RECON SERIES TUBE LEAK TEST GUNS

RECON 1500 - Vacuum



Easy to hold and use with superior grip ergonomics.



Field replaceable Venturi System



Use in tight workspaces because of its thin profile.

RECON VACUUM TEST GUNS

Safe & Ergonomic

Superior Grip

Easy to hold and use with superior grip ergonomics, utilizing a non-slip, wrinkle-coat finish on the handle.

Works Great In Small Spaces

Easy to use in tight work spaces because of its thin profile.

Operator Friendly

Reduce operator fatigue and increase efficiency with the lightweight aluminum body.

Increased Productivity

Easy To Use

Simply insert the seals into both ends of the tube, pull the trigger to evacuate the air, and monitor.

Works With A Variety Of Sizes

Tapered seal design allows the operator to test a large range of tube IDs without changing seals, washers, or support tube assemblies.

Easy Maintenance

Avoid replacing the entire test gun in the case of damage, with the field replaceable Venturi System. It's quick and easy to replace the filter element that protects the gun from harmful debris.

Long Tool Life

Durable cast aluminum body that protects the working components and a steel gauge body to protect the gauge.

Specifications:

RECON 1500 Air Requirements:

- Minimum - 40 PSI (2.7 bar)
- Maximum - 130 PSI (8.9 bar)



PLUG



CONTENTS

| | |
|-----------------------------|-----|
| One-Piece Tube Plugs..... | 166 |
| Two-Piece Tube Plugs..... | 170 |
| Mechanical Tube Plugs | 174 |

ONE-PIECE TUBE PLUGS

Tube Size

- 0.375" to 3.000" OD
- 9.5mm to 76.2mm OD

Maximum Pressure

- 150 PSI (1.03 MPa)

Maximum Temperature

- 400°F (205°C)

Elliott's One-Piece Tube Plugs cover a wide tube OD range, making them ideal for sealing leaky tubes in both heat exchangers and boilers.

It is good practice to install a plug that is the same as or a compatible material to the tube to be plugged. The tube plugs are available in an array of materials to suit your needs: brass, carbon steel, 304 stainless steel, 316 stainless steel, 416 stainless steel, aluminum, and Monel (other materials are available upon request). Elliott recommends puncturing the leaky tube with a One-Revolution Tube Cutter. This will ensure the tube is properly vented prior to plugging.

Features & Benefits:

- Quick method to plug leaky tubes - less labor cost.
- Easy to weld to tube sheet - peace of mind.
- Plug covers multiple tube sizes - less inventory cost.
- Material certifications included for traceability and safety compliance.

Spares & Accessories:

- One Revolution Tube Cutter: Utilize to puncture the tube to ensure the tube is properly vented so pressure cannot build up in the tube and cause the plugs to loosen. See page 188.

Specifications & Compliance:

Elliott's One-Piece Tube Plugs are designed to comply with ASME PCC-2 Section 312-4.2 and should be used in the following conditions:

- Pressure <150psi (1.03MPa) (Section 312-4.2-b-1)
- Temperature <400°F (205°C) (Section 312-4.2-b-2)
- Expanded only tubesheet joints (no seal or strength weld) (Section 312-4.2-b-3)
- Tubes pierced per ASME PCC-2 2022 Section 312-4.2-a or meeting requirements in Section 312-4.2-b-4



ONE-PIECE TUBE PLUGS

| Part Number Material Prefixes | | | | | | | |
|-------------------------------|--------------|---------------------|-----------------|-------|-------|----------|-------|
| Brass | Carbon Steel | SA-105 Carbon Steel | Stainless Steel | | | Aluminum | Monel |
| | | | 316 | 304 | 416 | | |
| 7180* | 7181* | 7179* | 7182* | 7183* | 7184* | 7185* | 7186* |

Note: Additional sizes and materials are available upon request.

| Tube OD | | BWG | Suggested Tube ID Range | Plug OD Ranges | Plug 10 Pack* |
|---------|------|-------|------------------------------------|------------------------------------|---------------|
| Inch | mm | | | | |
| 3/8" | 9.5 | 13-22 | 0.185" - 0.319" (4.7 - 8.1mm) | 0.178" - 0.375" (4.5 - 9.5mm) | XXXX-209-10 |
| 1/2" | 12.7 | 11-12 | | | |
| 1/2" | 12.7 | 13-22 | 0.310" - 0.444" (7.9 - 11.3mm) | 0.303" - 0.500" (7.7 - 12.7mm) | XXXX-334-10 |
| 5/8" | 15.9 | 11-12 | | | |
| 5/8" | 15.9 | 13-22 | 0.435" - 0.569" (11.0 - 14.5mm) | 0.428" - 0.625" (10.9 - 15.9mm) | XXXX-459-10 |
| 3/4" | 19.1 | 11-12 | | | |
| 3/4" | 19.1 | 13-22 | 0.560" - 0.694" (14.2 - 17.6mm) | 0.553" - 0.750" (14.0 - 19.1mm) | XXXX-584-10 |
| 7/8" | 22.2 | 11-12 | | | |
| 7/8" | 22.2 | 13-22 | 0.685" - 0.819" (17.4 - 20.8mm) | 0.678" - 0.875" (17.2 - 22.2mm) | XXXX-709-10 |
| 1" | 25.4 | 11-12 | | | |
| 1" | 25.4 | 13-22 | 0.810" - 0.944" (20.6 - 24.0mm) | 0.803" - 1.000" (20.4 - 25.4mm) | XXXX-834-10 |
| 1-1/8" | 28.6 | 11-12 | | | |
| 1-1/8" | 28.6 | 13-22 | 0.935" - 1.069" (23.7 - 27.2mm) | 0.928" - 1.125" (23.6 - 28.6mm) | XXXX-959-10 |
| 1-1/4" | 31.8 | 11-12 | | | |
| 1-1/4" | 31.8 | 13-22 | 1.060" - 1.194" (26.9 - 30.3mm) | 1.053" - 1.250" (26.7 - 31.8mm) | XXXX-1084-10 |
| 1-3/8" | 34.9 | 11-12 | | | |
| 1-3/8" | 34.9 | 13-22 | 1.185" - 1.319" (30.1 - 33.5mm) | 1.178" - 1.375" (29.9 - 34.9mm) | XXXX-1209-10 |
| 1-1/2" | 38.1 | 11-12 | | | |
| 1-1/2" | 38.1 | 13-22 | 1.310" - 1.444" (33.3 - 36.7mm) | 1.303" - 1.500" (33.1 - 38.1mm) | XXXX-1334-10 |
| 1-3/4" | 44.5 | 11-12 | | | |
| 1-3/4" | 44.5 | 13-22 | 1.560" - 1.694" (39.6 - 43.0mm) | 1.553" - 1.750" (39.4 - 44.5mm) | XXXX-1584-10 |
| 2" | 50.8 | 11-12 | | | |
| 2" | 50.8 | 13-22 | 1.760" - 1.782" (44.7 - 45.3mm) | 1.678" - 1.875" (42.6 - 47.6mm) | XXXX-1709-10 |
| 2" | 50.8 | 13-22 | | | |
| 2-1/4" | 57.2 | 11-12 | 1.810" - 1.944" (46.0 - 49.4mm) | 1.803" - 2.000" (45.8 - 50.8mm) | XXXX-1834-10 |
| 2-1/4" | 57.2 | 13-22 | | | |
| 2-1/4" | 57.2 | 13-22 | 2.010" - 2.032" (51.1 - 51.6mm) | 1.928" - 2.125" (49.0 - 54.0mm) | XXXX-1959-10 |
| 2-1/4" | 57.2 | 13-22 | | | |
| 2-1/2" | 63.5 | 11-12 | 2.060" - 2.194" (52.3 - 55.7mm) | 2.053" - 2.250" (52.1 - 57.2mm) | XXXX-2084-10 |
| 2-1/2" | 63.5 | 13-22 | | | |
| 2-1/2" | 63.5 | 13-22 | 2.260" - 2.282" (57.4 - 57.9mm) | 2.178" - 2.375" (55.3 - 60.3mm) | XXXX-2209-10 |
| 2-1/2" | 63.5 | 13-22 | | | |
| 2-1/2" | 63.5 | 13-22 | 2.310" - 2.444" (58.7 - 62.1mm) | 2.303" - 2.500" (58.5 - 63.5mm) | XXXX-2334-10 |
| 2-3/4" | 69.9 | 11-12 | | | |
| 2-3/4" | 69.9 | 11-12 | 2.510" - 2.532" (63.8 - 64.3mm) | 2.428" - 2.625" (61.7 - 66.7mm) | XXXX-2459-10 |
| 2-3/4" | 69.9 | 13-22 | | | |
| 2-3/4" | 69.9 | 13-22 | 2.560" - 2.694" (65.0 - 68.4mm) | 2.553" - 2.750" (64.8 - 69.9mm) | XXXX-2584-10 |
| 2-3/4" | 69.9 | 13-22 | | | |
| 3" | 76.2 | 11-12 | 2.760" - 2.782" (70.1 - 70.7mm) | 2.678" - 2.875" (68.0 - 73.0mm) | XXXX-2709-10 |
| 3" | 76.2 | 13-22 | | | |
| 3" | 76.2 | 13-22 | 2.810" - 2.944" (71.4 - 74.8mm) | 2.803" - 3.000" (71.2 - 76.2mm) | XXXX-2834-10 |

* Plugs are only available in 10 packs.

XXXX signifies material designation. Replace with the appropriate material found above (ie. 7180-584-10)



3 STRATEGIES FOR

SUCCESSFUL HEAT EXCHANGER TUBE PLUGGING



PLUGGING LEAKING TUBES in heat exchangers is a critical maintenance task to ensure safe and efficient operations. However, this seemingly straightforward procedure can present a multitude of challenges that can impact both the success of the plug and the overall maintenance process.

These challenges include creating a secure seal due to suboptimal tube conditions, limited reach and accessibility, and the availability of suitable plugging materials in emergency situations.

SEALING ABILITY & SUBOPTIMAL TUBE CONDITIONS

Achieving a secure, leak-proof seal when plugging a tube, especially in high-pressure exchangers, is critical. However, the condition of the tube itself can significantly impact the success of the plug. Fouling, scaling, ovality, pitting, and wall loss are common occurrences in highly corrosive environments or vessels experiencing significant wear. These conditions can hinder the proper seating of the plug and compromise the integrity of the seal.

One-piece plugs generally do not face significant sealing challenges in extreme conditions. This is primarily due to their application in either low-pressure settings or high-pressure environments where they are welded in place, effectively overcoming any issues related to wall loss or other tube irregularities.

Similarly, two-piece plugs, typically used in chillers, are generally not severely impacted by suboptimal tube conditions. The design of the two-piece plug, when installed correctly, inherently mitigates the effects of tube defects.

Mechanical plugs, however, can face sealing challenges in suboptimal conditions, since their design relies on the plug expanding and creating a tight seal against the tube's inner diameter. To get the most success, there are a few practices that should be followed:

- **Thorough Tube Preparation:** Utilize a prep brush to remove debris and create a clean, primed surface for the plug. In cases of significant irregularity or damage, reaming the tube may be necessary.
- **Tube Ovality:** If tube is out of round, re-rolling can restore its circularity, providing a more consistent and reliable surface for the plug to engage with.

REACH & ACCESSIBILITY

Limited reach and accessibility are frequent challenges encountered during plugging operations. Before starting a job, it's crucial to carefully assess the distance to the tube sheet and its thickness.

When working through channels or headers, establishing and maintaining consistent reach is essential. Marking off a specific extension for each tool used ensures that cleaning, measuring, and plugging operations are performed consistently within the same area of the tube.

The location and configuration of the vessel will significantly influence the required tools and equipment. For example, offline-installed vessels may present different accessibility challenges compared to offline-removed vessels, potentially requiring special equipment.

AVAILABILITY OF EXOTIC MATERIALS

Refineries and plants often utilize a wide range of vessels, many requiring specialized plug materials. Due to the potential for extended lead times and increased costs associated with procuring exotic materials, it is highly beneficial to maintain comprehensive records of all vessels on site, including their tube materials and sizes.

Establishing an on-site inventory of spare tubing, plugs, and expanders for commonly used materials can significantly reduce downtime and costs in emergency situations, enabling prompt repairs and minimizing operational disruptions.

Successful tube plugging requires a proactive approach to overcome suboptimal tube conditions, limited reach and accessibility, and the availability of exotic materials. By implementing thorough tube preparation techniques, carefully planning access routes, and maintaining a well-stocked inventory of essential materials, operators can significantly improve the efficiency and success rate of tube plugging operations, ensuring the continued safe and reliable operation of critical heat exchanger equipment.

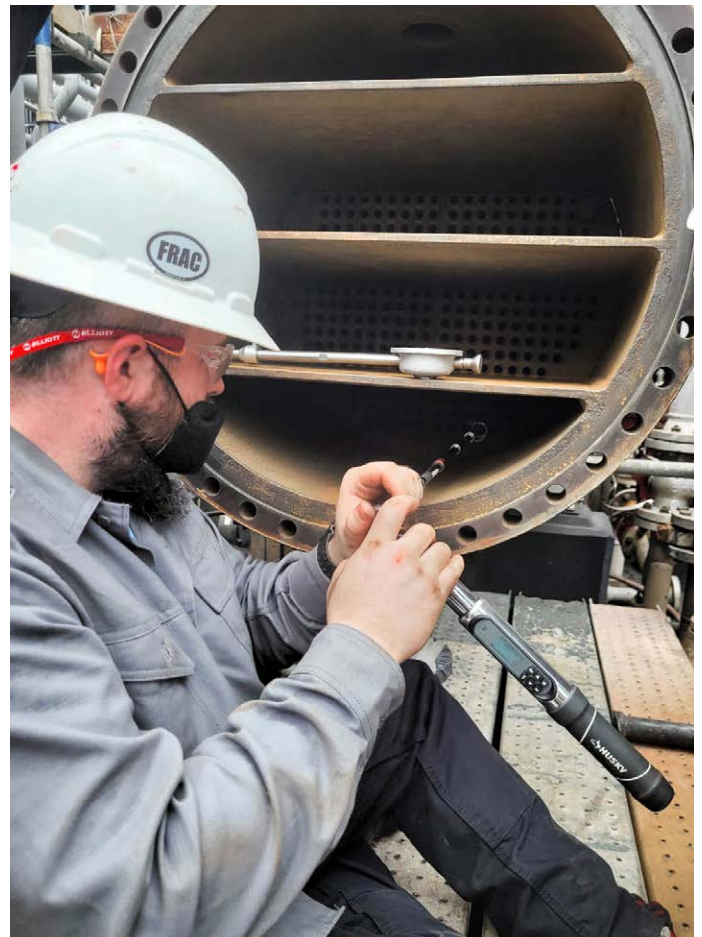

TWO-PIECE TUBE PLUGS

Tube Size

- 0.375" to 1.250" OD
- 9.5mm to 31.8mm OD

Maximum Pressure

- 150 PSI (1.03 MPa)

Maximum Temperature

- 400°F (205°C)

Elliott's Two-Piece Tube Plugs offer more sealing compared to One-Piece Plugs. The tapered pin is driven into the ring, which is tapered on the inside and is parallel to the tube on the outside. This gives even expansion to the ring and a long contact to the seal.

It is good practice to install rings and pins that are the same as or a compatible material to the tube to be plugged. The tube plugs are available in an array of materials to suit your needs: brass, carbon steel, 316 stainless steel, 416 stainless steel, and aluminum (other materials are available upon request). Elliott recommends puncturing the leaky tube with a One-Revolution Tube Cutter. This will ensure the tube is properly vented prior to plugging.



Features & Benefits:

- Better method to plug leaky tubes - less labor cost.
- Larger sealing surface - less chance for repeat leaking.
- Does not damage the tube sheet - no tube sheet repair cost.

Spares & Accessories:

- One Revolution Tube Cutter: Utilize to puncture the tube to ensure the tube is properly vented so pressure cannot build up in the tube and cause the plugs to loosen. See page 188.

Specifications & Compliance:

Elliott's Two-Piece Tube Plugs are designed to comply with ASME PCC-2 Section 312-4.2 and should be used in the following conditions:

- Pressure <150psi (1.03MPa) (Section 312-4.2-b-1)
- Temperature <400°F (205°C) (Section 312-4.2-b-2)
- Expanded only tubesheet joints (no seal or strength weld) (Section 312-4.2-b-3)
- Tubes pierced per ASME PCC-2 2022 Section 312-4.2-a or meeting requirements in Section 312-4.2-b-4



TWO-PIECE TUBE PLUGS

TWO-PIECE TUBE PLUGS

| Two-Piece Plug | | | | | | | | | | | | | | | | |
|------------------|---------------|-----------------|---------------|------------------------|---------------|-------------------------------|---------------|-------------------------------|---------------|---------------------|---------------|---------------|---------------|---------------|---------------|---------------|
| Tube OD | BWG | Brass- 10 Pack* | | Carbon Steel- 10 Pack* | | 316 Stainless Steel- 10 Pack* | | 416 Stainless Steel- 10 Pack* | | Aluminum - 10 Pack* | | | | | | |
| | | Ring | Pin | Ring | Pin | Ring | Pin | Ring | Pin | Ring | Pin | | | | | |
| 3/8" (9.5mm) | 20 | 853002-308-10 | 853103-312-10 | 853102-308-10 | 853003-312-10 | 861802-308-10 | 861803-312-10 | 852902-308-10 | 852903-312-10 | 861902-308-10 | 861903-312-10 | | | | | |
| | 21 | 853002-315-10 | | 853102-315-10 | | 861802-315-10 | | 852902-315-10 | | 861902-315-10 | | | | | | |
| | 22 | 853002-322-10 | | 853102-322-10 | | 861802-322-10 | | 852902-322-10 | | 861902-322-10 | | | | | | |
| | 23 | 853002-333-10 | | 853102-333-10 | | 861802-333-10 | | 852902-333-10 | | 861902-333-10 | | | | | | |
| | 24 | 853002-363-10 | | 853102-363-10 | | 861802-363-10 | | 852902-363-10 | | 861902-363-10 | | | | | | |
| 1/2" (12.7mm) | 15 | 853002-377-10 | 853103-375-10 | 853102-377-10 | 853003-375-10 | 861802-377-10 | 861803-375-10 | 852902-377-10 | 852903-375-10 | 861902-377-10 | 861903-375-10 | | | | | |
| | 16 | 853002-390-10 | | 853102-390-10 | | 861802-390-10 | | 852902-390-10 | | 861902-390-10 | | | | | | |
| | 17 | 853002-407-10 | | 853102-407-10 | | 861802-407-10 | | 852902-407-10 | | 861902-407-10 | | | | | | |
| | 18 | 853002-418-10 | | 853102-418-10 | | 861802-418-10 | | 852902-418-10 | | 861902-418-10 | | | | | | |
| | 19 | 853002-435-10 | | 853102-435-10 | | 861802-435-10 | | 852902-435-10 | | 861902-435-10 | | | | | | |
| | 21 | 853002-440-10 | | 853103-437-10 | | 853102-440-10 | | 853003-437-10 | | 861802-440-10 | | 861803-437-10 | 852902-440-10 | 852903-437-10 | 861902-440-10 | 861903-437-10 |
| | 22 | 853002-445-10 | | | | 853102-445-10 | | | | 861802-445-10 | | | 852902-445-10 | | 861902-445-10 | |
| | 23 | 853002-455-10 | | | | 853102-455-10 | | | | 861802-455-10 | | | 852902-455-10 | | 861902-455-10 | |
| 5/8" (15.9mm) | 11 | 853002-397-10 | 853103-375-10 | 853102-397-10 | 853003-375-10 | 861802-397-10 | 861803-375-10 | 852902-397-10 | 852903-375-10 | 861902-397-10 | 861903-375-10 | | | | | |
| | 12 | 853002-418-10 | | 853102-418-10 | | 861802-418-10 | | 852902-418-10 | | 861902-418-10 | | | | | | |
| | 13 | 853002-445-10 | 853103-437-10 | 853102-445-10 | 853003-437-10 | 861802-445-10 | 861803-437-10 | 852902-445-10 | 852903-437-10 | 861902-445-10 | 861903-437-10 | | | | | |
| | 14 | 853002-467-10 | | 853102-467-10 | | 861802-467-10 | | 852902-467-10 | | 861902-467-10 | | | | | | |
| | 15 | 853002-488-10 | | 853102-488-10 | | 861802-488-10 | | 852902-488-10 | | 861902-488-10 | | | | | | |
| | 16 | 853002-502-10 | 853103-500-10 | 853102-502-10 | 853003-500-10 | 861802-502-10 | 861803-500-10 | 852902-502-10 | 852903-500-10 | 861902-502-10 | 861903-500-10 | | | | | |
| | 17 | 853002-515-10 | | 853102-515-10 | | 861802-515-10 | | 852902-515-10 | | 861902-515-10 | | | | | | |
| | 18 | 853002-532-10 | | 853102-532-10 | | 861802-532-10 | | 852902-532-10 | | 861902-532-10 | | | | | | |
| | 19 | 853002-545-10 | | 853102-545-10 | | 861802-545-10 | | 852902-545-10 | | 861902-545-10 | | | | | | |
| | 20 | 853002-559-10 | | 853102-559-10 | | 861802-559-10 | | 852902-559-10 | | 861902-559-10 | | | | | | |
| 21 | 853002-564-10 | 853102-570-10 | 853102-564-10 | 861802-564-10 | 861802-564-10 | 852902-564-10 | 852902-564-10 | 861902-564-10 | 861902-564-10 | | | | | | | |
| 22 | 853002-570-10 | | 861802-570-10 | | 852902-570-10 | | 861902-570-10 | | | | | | | | | |
| 3/4" (19.1mm) | 9 | 853002-467-10 | 853103-437-10 | 853102-467-10 | 853003-437-10 | 861802-467-10 | 861803-437-10 | 852902-467-10 | 852903-437-10 | 861902-467-10 | 861903-437-10 | | | | | |
| | 10 | 853002-495-10 | | 853102-495-10 | | 861802-495-10 | | 852902-495-10 | | 861902-495-10 | | | | | | |
| | 11 | 853002-522-10 | 853103-500-10 | 853102-522-10 | 853003-500-10 | 861802-522-10 | 861803-500-10 | 852902-522-10 | 852903-500-10 | 861902-522-10 | 861903-500-10 | | | | | |
| | 12 | 853002-545-10 | | 853102-545-10 | | 861802-545-10 | | 852902-545-10 | | 861902-545-10 | | | | | | |
| | 13 | 853002-570-10 | | 853102-570-10 | | 861802-570-10 | | 852902-570-10 | | 861902-570-10 | | | | | | |

* Plugs are only available in 10 packs.

Note: Additional sizes and materials are available upon request. A minimum order quantity may be applicable for these special sizes and materials. Contact Customer Service for details.



TWO-PIECE TUBE PLUGS

TWO-PIECE TUBE PLUGS

| Two-Piece Plug- 10 Pack Part # | | | | | | | | | | | |
|--------------------------------|---------------|-----------------|---------------|------------------------|---------------|-------------------------------|---------------|-------------------------------|---------------|--------------------|---------------|
| Tube OD | BWG | Brass- 10 Pack* | | Carbon Steel- 10 Pack* | | 316 Stainless Steel- 10 Pack* | | 416 Stainless Steel- 10 Pack* | | Aluminum- 10 Pack* | |
| | | Ring | Pin | Ring | Pin | Ring | Pin | Ring | Pin | Ring | Pin |
| 3/4" (19.1mm) | 14 | 853002-590-10 | 853103-500-10 | 853102-590-10 | 853003-500-10 | 861802-590-10 | 861803-500-10 | 852902-590-10 | 852903-500-10 | 861902-590-10 | 861903-500-10 |
| | 15 | 853002-613-10 | 853103-1-10 | 853102-613-10 | 853003-1-10 | 861802-613-10 | 861803-1-10 | 852902-613-10 | 852903-1-10 | 861902-613-10 | 861903-1-10 |
| | 16 | 853002-631-10 | | 853102-631-10 | | 861802-631-10 | | 852902-631-10 | | 861902-631-10 | |
| | 17 | 853002-640-10 | | 853102-640-10 | | 861802-640-10 | | 852902-640-10 | | 861902-640-10 | |
| | 18 | 853002-657-10 | | 853102-657-10 | | 861802-657-10 | | 852902-657-10 | | 861902-657-10 | |
| | 19 | 853002-670-10 | | 853102-670-10 | | 861802-670-10 | | 852902-670-10 | | 861902-670-10 | |
| | 20 | 853002-685-10 | | 853102-685-10 | | 861802-685-10 | | 852902-685-10 | | 861902-685-10 | |
| | 21 | 853002-690-10 | 853103-1A-10 | 853102-690-10 | 853003-1A-10 | 861802-690-10 | 861803-1A-10 | 852902-690-10 | 852903-1A-10 | 861902-690-10 | 861903-1A-10 |
| 22 | 853002-695-10 | 853102-695-10 | | 861802-695-10 | | 852902-695-10 | | 861902-695-10 | | | |
| 7/8" (22.2mm) | 9 | 853002-590-10 | 853103-500-10 | 853102-590-10 | 853003-500-10 | 861802-590-10 | 861803-500-10 | 852902-590-10 | 852903-500-10 | 861902-590-10 | 861903-500-10 |
| | 10 | 853002-620-10 | 853103-1-10 | 853102-620-10 | 853003-1-10 | 861802-620-10 | 861803-1-10 | 852902-620-10 | 852903-1-10 | 861902-620-10 | 861903-1-10 |
| | 11 | 853002-647-10 | | 853102-647-10 | | 861802-647-10 | | 852902-647-10 | | 861902-647-10 | |
| | 12 | 853002-670-10 | | 853102-670-10 | | 861802-670-10 | | 852902-670-10 | | 861902-670-10 | |
| | 13 | 853002-695-10 | 853103-1A-10 | 853102-695-10 | 853003-1A-10 | 861802-695-10 | 861803-1A-10 | 852902-695-10 | 852903-1A-10 | 861902-695-10 | 861903-1A-10 |
| | 14 | 853002-719-10 | | 853102-719-10 | | 861802-719-10 | | 852902-719-10 | | 861902-719-10 | |
| | 15 | 853002-738-10 | | 853102-738-10 | | 861802-738-10 | | 852902-738-10 | | 861902-738-10 | |
| | 16 | 853002-752-10 | | 853102-752-10 | | 861802-752-10 | | 852902-752-10 | | 861902-752-10 | |
| | 17 | 853002-765-10 | 853102-765-10 | 861802-765-10 | 852902-765-10 | 861902-765-10 | | | | | |
| | 18 | 853002-782-10 | 853103-2-10 | 853102-782-10 | 853003-2-10 | 861802-782-10 | 861803-2-10 | 852902-782-10 | 852903-2-10 | 861902-782-10 | 861903-2-10 |
| 19 | 853002-793-10 | 853102-793-10 | | 861802-793-10 | | 852902-793-10 | | 861902-793-10 | | | |
| 20 | 853002-809-10 | 853102-809-10 | | 861802-809-10 | | 852902-809-10 | | 861902-809-10 | | | |
| 21 | 853002-820-10 | 853102-820-10 | | 861802-820-10 | | 852902-820-10 | | 861902-820-10 | | | |
| 22 | 853002-820-10 | 853102-820-10 | | 861802-820-10 | | 852902-820-10 | | 861902-820-10 | | | |
| 1" (25.4mm) | 8 | 853002-687-10 | 853103-1A-10 | 853102-687-10 | 853003-1A-10 | 861802-687-10 | 861803-1A-10 | 852902-687-10 | 852903-1A-10 | 861902-687-10 | 861903-1A-10 |
| | 9 | 853002-719-10 | | 853102-719-10 | | 861802-719-10 | | 852902-719-10 | | 861902-719-10 | |
| | 10 | 853002-745-10 | | 853102-745-10 | | 861802-745-10 | | 852902-745-10 | | 861902-745-10 | |
| | 11 | 853002-772-10 | | 853102-772-10 | | 861802-772-10 | | 852902-772-10 | | 861902-772-10 | |
| | 12 | 853002-793-10 | 853103-2-10 | 853102-793-10 | 853003-2-10 | 861802-793-10 | 861803-2-10 | 852902-793-10 | 852903-2-10 | 861902-793-10 | 861903-2-10 |
| | 13 | 853002-820-10 | | 853102-820-10 | | 861802-820-10 | | 852902-820-10 | | 861902-820-10 | |
| 14 | 853002-845-10 | 853102-845-10 | | 861802-845-10 | | 852902-845-10 | | 861902-845-10 | | | |

* Plugs are only available in 10 packs.

Note: Additional sizes and materials are available upon request. A minimum order quantity may be applicable for these special sizes and materials. Contact Customer Service for details.



TWO-PIECE TUBE PLUGS

TWO-PIECE TUBE PLUGS

| Two-Piece Plug- 10 Pack Part # | | | | | | | | | | | |
|--------------------------------|----------------|-----------------|----------------|------------------------|----------------|-------------------------------|---------------|-------------------------------|--------------|---------------------|--------------|
| Tube OD | BWG | Brass- 10 Pack* | | Carbon Steel- 10 Pack* | | 316 Stainless Steel- 10 Pack* | | 416 Stainless Steel- 10 Pack* | | Aluminum - 10 Pack* | |
| | | Ring | Pin | Ring | Pin | Ring | Pin | Ring | Pin | Ring | Pin |
| 1" (25.4mm) | 15 | 853002-863-10 | 853103-2-10 | 853102-863-10 | 853003-2-10 | 861802-863-10 | 861803-2-10 | 852902-863-10 | 852903-2-10 | 861902-863-10 | 861903-2-10 |
| | 16 | 853002-877-10 | 853103-2A-10 | 853102-877-10 | 853003-2A-10 | 861802-877-10 | 861803-2A-10 | 852902-877-10 | 852903-2A-10 | 861902-877-10 | 861903-2A-10 |
| | 17 | 853002-890-10 | | 853102-890-10 | | 861802-890-10 | | 852902-890-10 | | 861902-890-10 | |
| | 18 | 853002-907-10 | | 853102-907-10 | | 861802-907-10 | | 852902-907-10 | | 861902-907-10 | |
| | 19 | 853002-918-10 | | 853102-918-10 | | 861802-918-10 | | 852902-918-10 | | 861902-918-10 | |
| | 20 | 853002-934-10 | | 853102-934-10 | | 861802-934-10 | | 852902-934-10 | | 861902-934-10 | |
| | 21 | 853002-937-10 | | 853102-937-10 | | 861802-937-10 | | 852902-937-10 | | 861902-937-10 | |
| | 22 | 853002-945-10 | | 853102-945-10 | | 861802-945-10 | | 852902-945-10 | | 861902-945-10 | |
| 1-1/8" (28.6mm) | 8 | 853002-812-10 | | 853103-2-10 | | 853102-812-10 | | 853003-2-10 | | 861802-812-10 | |
| | 9 | 853002-845-10 | 853102-845-10 | | 861802-845-10 | 852902-845-10 | 861902-845-10 | | | | |
| | 10 | 853002-870-10 | 853102-870-10 | | 861802-870-10 | 852902-870-10 | 861902-870-10 | | | | |
| | 11 | 853002-897-10 | 853103-2A-10 | 853102-897-10 | 853003-2A-10 | 861802-897-10 | 861803-2A-10 | 852902-897-10 | 852903-2A-10 | 861902-897-10 | 861903-2A-10 |
| | 12 | 853002-918-10 | | 853102-918-10 | | 861802-918-10 | | 852902-918-10 | | 861902-918-10 | |
| | 13 | 853002-945-10 | | 853102-945-10 | | 861802-945-10 | | 852902-945-10 | | 861902-945-10 | |
| | 14 | 853002-969-10 | | 853103-3-10 | | 853102-969-10 | | 853003-3-10 | | 861802-969-10 | |
| | 15 | 853002-988-10 | 853102-988-10 | | 861802-988-10 | 852902-988-10 | 861902-988-10 | | | | |
| 16 | 853002-1002-10 | 853102-1002-10 | 861802-1002-10 | | 852902-1002-10 | 861902-1002-10 | | | | | |
| 17 | 853002-1015-10 | 853102-1015-10 | 861802-1015-10 | | 852902-1015-10 | 861902-1015-10 | | | | | |
| 18 | 853002-1032-10 | 853102-1032-10 | 861802-1032-10 | 852902-1032-10 | 861902-1032-10 | | | | | | |
| 1-1/4" (31.8mm) | 8 | 853002-937-10 | 853103-2A-10 | 853102-937-10 | 853003-2A-10 | 861802-937-10 | 861803-2A-10 | 852902-937-10 | 852903-2A-10 | 861902-937-10 | 861903-2A-10 |
| | 9 | 853002-969-10 | 853103-3-10 | 853102-969-10 | 853003-3-10 | 861802-969-10 | 861803-3-10 | 852902-969-10 | 852903-3-10 | 861902-969-10 | 861903-3-10 |
| | 10 | 853002-995-10 | | 853102-995-10 | | 861802-995-10 | | 852902-995-10 | | 861902-995-10 | |
| | 11 | 853002-1022-10 | | 853102-1022-10 | | 861802-1022-10 | | 852902-1022-10 | | 861902-1022-10 | |
| | 12 | 853002-1043-10 | | 853102-1043-10 | | 861802-1043-10 | | 852902-1043-10 | | 861902-1043-10 | |
| | 13 | 853002-1070-10 | 853103-3A-10 | 853102-1070-10 | 853003-3A-10 | 861802-1070-10 | 861803-3A-10 | 852902-1070-10 | 852903-3A-10 | 861902-1070-10 | 861903-3A-10 |
| | 14 | 853002-1092-10 | | 853102-1092-10 | | 861802-1092-10 | | 852902-1092-10 | | 861902-1092-10 | |
| | 15 | 853002-1113-10 | | 853102-1113-10 | | 861802-1113-10 | | 852902-1113-10 | | 861902-1113-10 | |
| 16 | 853002-1127-10 | 853102-1127-10 | | 861802-1127-10 | | 852902-1127-10 | | 861902-1127-10 | | | |
| 17 | 853002-1140-10 | 853102-1140-10 | | 861802-1140-10 | | 852902-1140-10 | | 861902-1140-10 | | | |
| 18 | 853002-1157-10 | 853102-1157-10 | 861802-1157-10 | 852902-1157-10 | 861902-1157-10 | | | | | | |

* Plugs are only available in 10 packs.

Note: Additional sizes and materials are available upon request. A minimum order quantity may be applicable for these special sizes and materials. Contact Customer Service for details.



MECHANICAL TUBE PLUGS

Tube Size

- 0.410" to 1.000" ID
- 10.4mm to 25.4mm ID

Maximum Pressure

- 1,000 or 6,500 PSI

Elliott's mechanical plugs create a positive mechanical contact seal up to 1,000 PSI (68.95 bar) or 6,500 PSI (448.2 bar), making them ideal for medium and high pressure applications such as feedwater heaters and other high pressure heat exchangers over 200 PSI (13.8 bar) and is compliant with ASME PCC-2-2015. As the most secure method to plug leaky tubes, they can also be used in low pressure applications for peace of mind.

Elliott's mechanical plugs have been used by customers for more than 30 years. Our proven design makes them the most secure method to plug leaky tubes. Setup of the mechanical plug is quick and easy because the plug is installed without a hydraulic ram. With only a plug and hand torque wrench, the operator is ready to plug tubes. Simply insert the plug into the tube and expand with a standard 3/8" drive torque wrench. The plug will expand approximately 0.030" (0.76mm) to provide a positive mechanical contact seal. The one piece design allows operators to easily plug tubes in tight spaces like hemispherical heads, baffle plates, and dividers.

It is good practice to install tube plugs that are the same as or a compatible material to the tube and tube sheet. The tube plugs are available in an array of materials to suit your needs: brass, carbon steel, stainless steel, titanium, Monel, and copper nickel. Elliott recommends puncturing the leaky tube with a One-Revolution Tube Cutter. This will ensure the tube is properly vented prior to plugging.

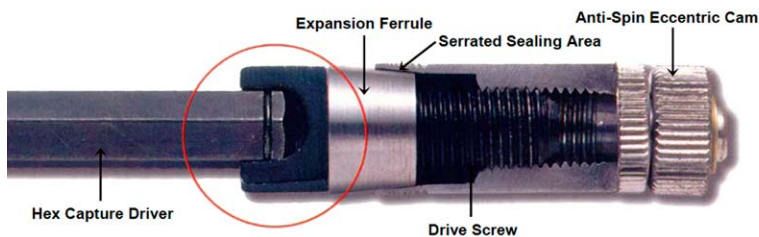

Patented Hex Drive Capture System

New hex drivers have a spring loaded tang that captures the plug onto the end of the drive preventing it from falling off into the heat exchanger tube.

Features & Benefits:

Peace Of Mind

Most secure method to plug leaky tubes. No welding required.

Expands In Tube

Can be installed into hard to reach areas and at any depth of the tube sheet, avoiding severely corroded areas on the tube sheet face.

Low Investment

No expensive capital equipment required.

Protects The Tube Sheet

Wide sealing zone ensures a positive seal with a gradual and symmetrical torque expansion – Eliminates thermal and mechanical shock to the tube sheet.



MECHANICAL TUBE PLUGS

Spares & Accessories:

- Tube Prep Brushes, [see page 176](#)
- Brush Extensions, [see page 179](#)
- Mechanical Plug Removal Kit, [see page 179](#)
- Torque Wrench, 8830TW: Use to install the high pressure tube plug into the tube.
- One Revolution Tube Cutter: Utilize to puncture the tube to ensure the tube is properly vented so pressure cannot build up in the tube and cause the plugs to loosen. [See page 188](#)

Specifications:

- Pressure: 1,000 PSI (68.95 bar) or 6,500 PSI (448.2 bar).
- Temperature: Up to 1,750°F (954.4°C).
- Standard Reach: 5" for 1/4" and 5/16" drive, 6-1/2" for 3/8" drive.

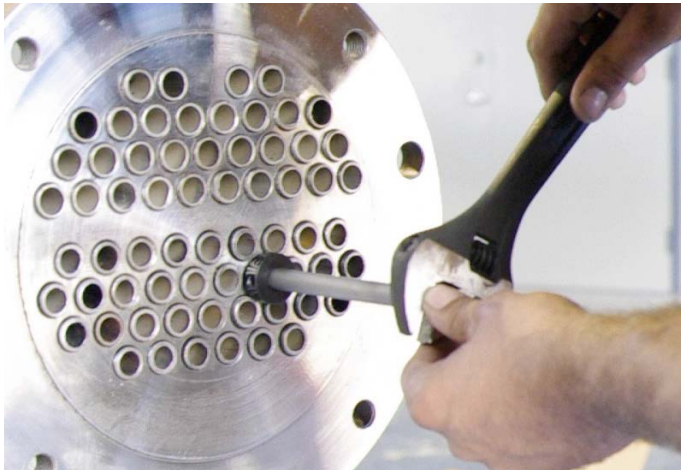

Quality Assurance:

Tested to meet or exceed all of the following industry standards:

| Industry Standards |
|--|
| ASME B31.3 |
| ASME Section VII Division 1 |
| CSA B51 |
| CSA Z662 |
| TEMA |
| CAN/CSA 285.0 6.1.6 Cat H |
| ASME PCC-2-2015 |
| ISO-9001: 2008 Standards for: <ul style="list-style-type: none">• ASME Section VII• API 660• Alberta (ABSA)• Ontario (TSSA) |

Visit our website to read the comprehensive testing report,
www.elliott-tool.com/mechanical-tube-plugs/



Visit our YouTube channel to learn how to install and remove mechanical plugs easily!

www.youtube.com/elliott-tool



MECHANICAL TUBE PLUGS

Medium Pressure - Up To 1,000 PSI

MECHANICAL TUBE PLUGS

The below size recommendations assume a 5% wall reduction and 0.010" (0.254mm) clearance between the tube and tube sheet hole.

| Tube Size | | Measured Tube ID Range (Up to 1,000 PSI) | | Plug OD | | Prep Brush | Plug Part # (10 Packs) | | | | | |
|------------------|-------|---|---------------|---------------|-------|------------|------------------------|--------------|---------------------|-------------|-------------|-------------|
| OD | BWG | Inch | mm | Inch | mm | | Brass | Carbon Steel | 316 Stainless Steel | Titanium | Monel | 90/10 Cu-Ni |
| 1/2" (12.7mm) | 19 | 0.410 - 0.445 | 10.41 - 11.30 | 0.405 | 10.29 | MPB-410 | 8830-410-10 | 8831-410-10 | 8832-410-10 | 8833-410-10 | 8834-410-10 | 8835-410-10 |
| | 20-22 | 0.430 - 0.465 | 10.92 - 11.81 | 0.425 | 10.80 | MPB-430 | 8830-430-10 | 8831-430-10 | 8832-430-10 | 8833-430-10 | 8834-430-10 | 8835-430-10 |
| | 24 | 0.450 - 0.485 | 11.43 - 12.32 | 0.445 | 11.30 | MPB-450 | 8830-450-10 | 8831-450-10 | 8832-450-10 | 8833-450-10 | 8834-450-10 | 8835-450-10 |
| 5/8" (15.9mm) | 13 | 0.430 - 0.465 | 10.92 - 11.81 | 0.425 | 10.80 | MPB-430 | 8830-430-10 | 8831-430-10 | 8832-430-10 | 8833-430-10 | 8834-430-10 | 8835-430-10 |
| | 14 | 0.450 - 0.485 | 11.43 - 12.32 | 0.445 | 11.30 | MPB-450 | 8830-450-10 | 8831-450-10 | 8832-450-10 | 8833-450-10 | 8834-450-10 | 8835-450-10 |
| | 15 | 0.470 - 0.505 | 11.94 - 12.83 | 0.465 | 11.81 | MPB-470 | 8830-470-10 | 8831-470-10 | 8832-470-10 | 8833-470-10 | 8834-470-10 | 8835-470-10 |
| | 16 | 0.490 - 0.525 | 12.45 - 13.34 | 0.485 | 12.32 | MPB-490 | 8830-490-10 | 8831-490-10 | 8832-490-10 | 8833-490-10 | 8834-490-10 | 8835-490-10 |
| | 17 | 0.500 - 0.535 | 12.70 - 13.59 | 0.495 | 12.57 | MPB-510 | 8830-510-10 | 8831-510-10 | 8832-510-10 | 8833-510-10 | 8834-510-10 | 8835-510-10 |
| | 19 | 0.530 - 0.565 | 13.46 - 14.35 | 0.525 | 13.34 | MPB-530 | 8830-530-10 | 8831-530-10 | 8832-530-10 | 8833-530-10 | 8834-530-10 | 8835-530-10 |
| | 20-21 | 0.550 - 0.585 | 13.97 - 14.86 | 0.545 | 13.84 | MPB-550 | 8830-550-10 | 8831-550-10 | 8832-550-10 | 8833-550-10 | 8834-550-10 | 8835-550-10 |
| | 22-24 | 0.570 - 0.605 | 14.48 - 15.37 | 0.565 | 14.35 | MPB-570 | 8830-570-10 | 8831-570-10 | 8832-570-10 | 8833-570-10 | 8834-570-10 | 8835-570-10 |
| | 1" | 11 | 0.510 - 0.545 | 12.95 - 13.84 | 0.505 | 12.83 | MPB-510 | 8830-510-10 | 8831-510-10 | 8832-510-10 | 8833-510-10 | 8834-510-10 |
| 12 | | 0.530 - 0.565 | 13.46 - 14.35 | 0.525 | 13.34 | MPB-530 | 8830-530-10 | 8831-530-10 | 8832-530-10 | 8833-530-10 | 8834-530-10 | 8835-530-10 |
| 13 | | 0.550 - 0.585 | 13.97 - 14.86 | 0.545 | 13.84 | MPB-550 | 8830-550-10 | 8831-550-10 | 8832-550-10 | 8833-550-10 | 8834-550-10 | 8835-550-10 |
| 16 | | 0.610 - 0.645 | 15.49 - 16.38 | 0.605 | 15.37 | MPB-610 | 8830-610-10 | 8831-610-10 | 8832-610-10 | 8833-610-10 | 8834-610-10 | 8835-610-10 |
| 17 | | 0.630 - 0.665 | 16.00 - 16.89 | 0.625 | 15.88 | MPB-630 | 8830-630-10 | 8831-630-10 | 8832-630-10 | 8833-630-10 | 8834-630-10 | 8835-630-10 |
| 18-19 | | 0.650 - 0.685 | 16.51 - 17.40 | 0.645 | 16.38 | MPB-650 | 8830-650-10 | 8831-650-10 | 8832-650-10 | 8833-650-10 | 8834-650-10 | 8835-650-10 |
| 20 | | 0.670 - 0.705 | 17.02 - 17.91 | 0.665 | 16.89 | MPB-670 | 8830-670-10 | 8831-670-10 | 8832-670-10 | 8833-670-10 | 8834-670-10 | 8835-670-10 |
| 22-24 | | 0.690 - 0.725 | 17.53 - 18.42 | 0.685 | 17.40 | MPB-690 | 8830-690-10 | 8831-690-10 | 8832-690-10 | 8833-690-10 | 8834-690-10 | 8835-690-10 |
| 1 1/8" | 11 | 0.630 - 0.665 | 16.00 - 16.89 | 0.625 | 15.88 | MPB-630 | 8830-630-10 | 8831-630-10 | 8832-630-10 | 8833-630-10 | 8834-630-10 | 8835-630-10 |
| | 12 | 0.650 - 0.685 | 16.51 - 17.40 | 0.645 | 16.38 | MPB-650 | 8830-650-10 | 8831-650-10 | 8832-650-10 | 8833-650-10 | 8834-650-10 | 8835-650-10 |

Plugs are only available in 10 packs.

Additional sizes and materials available upon request.



MECHANICAL TUBE PLUGS

Medium Pressure - Up To 1,000 PSI

The below size recommendations assume a 5% wall reduction and 0.010" (0.254mm) clearance between the tube and tube sheet hole.

| Tube Size | | Measured Tube ID Range (Up to 1,000 PSI) | | Plug OD | | Prep Brush | Plug Part # (10 Packs) | | | | | |
|----------------|-------|---|---------------|---------|-------|------------|------------------------|--------------|---------------------|-------------|-------------|-------------|
| OD | BWG | Inch | mm | Inch | mm | | Brass | Carbon Steel | 316 Stainless Steel | Titanium | Monel | 90/10 Cu-Ni |
| | 15-16 | 0.730 - 0.765 | 18.54 - 19.43 | 0.725 | 18.42 | MPB-730 | 8830-730-10 | 8831-730-10 | 8832-730-10 | 8833-730-10 | 8834-730-10 | 8835-730-10 |
| | 17 | 0.750 - 0.785 | 19.05 - 19.94 | 0.745 | 18.92 | MPB-750 | 8830-750-10 | 8831-750-10 | 8832-750-10 | 8833-750-10 | 8834-750-10 | 8835-750-10 |
| | 18 | 0.770 - 0.805 | 19.56 - 20.45 | 0.765 | 19.43 | MPB-770 | 8830-770-10 | 8831-770-10 | 8832-770-10 | 8833-770-10 | 8834-770-10 | 8835-770-10 |
| | 19 | 0.780 - 0.815 | 19.81 - 20.70 | 0.775 | 19.69 | MPB-780 | 8830-780-10 | 8831-780-10 | 8832-780-10 | 8833-780-10 | 8834-780-10 | 8835-780-10 |
| | 20-21 | 0.800 - 0.835 | 20.32 - 21.21 | 0.795 | 20.19 | MPB-800 | 8830-800-10 | 8831-800-10 | 8832-800-10 | 8833-800-10 | 8834-800-10 | 8835-800-10 |
| | 24 | 0.820 - 0.855 | 20.83 - 21.72 | 0.815 | 20.70 | MPB-820 | 8830-820-10 | 8831-820-10 | 8832-820-10 | 8833-820-10 | 8834-820-10 | 8835-820-10 |
| 1" (25.4mm) | 10 | 0.730 - 0.765 | 18.54 - 19.43 | 0.725 | 18.42 | MPB-730 | 8830-730-10 | 8831-730-10 | 8832-730-10 | 8833-730-10 | 8834-730-10 | 8835-730-10 |
| | 12 | 0.780 - 0.815 | 19.81 - 20.70 | 0.775 | 19.69 | MPB-780 | 8830-780-10 | 8831-780-10 | 8832-780-10 | 8833-780-10 | 8834-780-10 | 8835-780-10 |
| | 13 | 0.800 - 0.835 | 20.32 - 21.21 | 0.795 | 20.19 | MPB-800 | 8830-800-10 | 8831-800-10 | 8832-800-10 | 8833-800-10 | 8834-800-10 | 8835-800-10 |
| | 16 | 0.860 - 0.895 | 21.84 - 22.73 | 0.855 | 21.72 | MPB-860 | 8830-860-10 | 8831-860-10 | 8832-860-10 | 8833-860-10 | 8834-860-10 | 8835-860-10 |
| | 17 | 0.880 - 0.915 | 22.35 - 23.24 | 0.875 | 22.23 | MPB-880 | 8830-880-10 | 8831-880-10 | 8832-880-10 | 8833-880-10 | 8834-880-10 | 8835-880-10 |
| | 18 | 0.900 - 0.935 | 22.86 - 23.75 | 0.895 | 22.73 | MPB-900 | 8830-900-10 | 8831-900-10 | 8832-900-10 | 8833-900-10 | 8834-900-10 | 8835-900-10 |
| | 20-21 | 0.920 - 0.955 | 23.37 - 24.26 | 0.915 | 23.24 | MPB-920 | 8830-920-10 | 8831-920-10 | 8832-920-10 | 8833-920-10 | 8834-920-10 | 8835-920-10 |
| | 22-24 | 0.940 - 0.975 | 23.88 - 24.77 | 0.935 | 23.75 | MPB-940 | 8830-940-10 | 8831-940-10 | 8832-940-10 | 8833-940-10 | 8834-940-10 | 8835-940-10 |
| | 10 | 0.980 - 1.015 | 24.89 - 25.78 | 0.975 | 24.78 | MPB-980 | 8830-980-10 | 8831-980-10 | 8832-980-10 | 8833-980-10 | 8834-980-10 | 8835-980-10 |

Plugs are only available in 10 packs.

Additional sizes and materials available upon request.



MECHANICAL TUBE PLUGS

High Pressure - Up to 6,500 PSI

MECHANICAL TUBE PLUGS

| Measured Tube ID Range (Up to 6,500 PSI) | | Plug OD | | Prep Brush | Plug Part # (10 Packs)* | | | | | |
|---|-------------|---------|-------|------------|-------------------------|--------------|---------------------|-------------|-------------|-------------|
| Inch | mm | Inch | mm | | Brass | Carbon Steel | 316 Stainless Steel | Titanium | Monel | 90/10 Cu-Ni |
| 0.410-0.429 | 10.41-10.92 | 0.405 | 10.29 | MPB-410 | 8830-410-10 | 8831-410-10 | 8832-410-10 | 8833-410-10 | 8834-410-10 | 8835-410-10 |
| 0.430-0.449 | 10.92-11.43 | 0.425 | 10.80 | MPB-430 | 8830-430-10 | 8831-430-10 | 8832-430-10 | 8833-430-10 | 8834-430-10 | 8835-430-10 |
| 0.450-0.469 | 11.43-11.94 | 0.445 | 11.30 | MPB-450 | 8830-450-10 | 8831-450-10 | 8832-450-10 | 8833-450-10 | 8834-450-10 | 8835-450-10 |
| 0.470-0.489 | 11.94-12.45 | 0.465 | 11.81 | MPB-470 | 8830-470-10 | 8831-470-10 | 8832-470-10 | 8833-470-10 | 8834-470-10 | 8835-470-10 |
| 0.490-0.509 | 12.45-12.95 | 0.485 | 12.32 | MPB-490 | 8830-490-10 | 8831-490-10 | 8832-490-10 | 8833-490-10 | 8834-490-10 | 8835-490-10 |
| 0.510-0.529 | 12.95-13.46 | 0.505 | 12.83 | MPB-510 | 8830-510-10 | 8831-510-10 | 8832-510-10 | 8833-510-10 | 8834-510-10 | 8835-510-10 |
| 0.530-0.549 | 13.46-13.97 | 0.525 | 13.34 | MPB-530 | 8830-530-10 | 8831-530-10 | 8832-530-10 | 8833-530-10 | 8834-530-10 | 8835-530-10 |
| 0.550-0.569 | 13.97-14.48 | 0.545 | 13.84 | MPB-550 | 8830-550-10 | 8831-550-10 | 8832-550-10 | 8833-550-10 | 8834-550-10 | 8835-550-10 |
| 0.570-0.589 | 14.48-14.99 | 0.565 | 14.35 | MPB-570 | 8830-570-10 | 8831-570-10 | 8832-570-10 | 8833-570-10 | 8834-570-10 | 8835-570-10 |
| 0.590-0.609 | 14.99-15.49 | 0.585 | 14.86 | MPB-590 | 8830-590-10 | 8831-590-10 | 8832-590-10 | 8833-590-10 | 8834-590-10 | 8835-590-10 |
| 0.610-0.629 | 15.49-16.00 | 0.605 | 15.37 | MPB-610 | 8830-610-10 | 8831-610-10 | 8832-610-10 | 8833-610-10 | 8834-610-10 | 8835-610-10 |
| 0.630-0.649 | 16.00-16.51 | 0.625 | 15.88 | MPB-630 | 8830-630-10 | 8831-630-10 | 8832-630-10 | 8833-630-10 | 8834-630-10 | 8835-630-10 |
| 0.650-0.669 | 16.51-17.02 | 0.645 | 16.38 | MPB-650 | 8830-650-10 | 8831-650-10 | 8832-650-10 | 8833-650-10 | 8834-650-10 | 8835-650-10 |
| 0.670-0.689 | 17.02-17.53 | 0.665 | 16.89 | MPB-670 | 8830-670-10 | 8831-670-10 | 8832-670-10 | 8833-670-10 | 8834-670-10 | 8835-670-10 |
| 0.690-0.709 | 17.53-18.03 | 0.685 | 17.40 | MPB-690 | 8830-690-10 | 8831-690-10 | 8832-690-10 | 8833-690-10 | 8834-690-10 | 8835-690-10 |
| 0.710-0.729 | 18.03-18.54 | 0.705 | 17.91 | MPB-710 | 8830-710-10 | 8831-710-10 | 8832-710-10 | 8833-710-10 | 8834-710-10 | 8835-710-10 |
| 0.730-0.749 | 18.54-19.05 | 0.725 | 18.42 | MPB-730 | 8830-730-10 | 8831-730-10 | 8832-730-10 | 8833-730-10 | 8834-730-10 | 8835-730-10 |
| 0.750-0.769 | 19.05-19.56 | 0.745 | 18.92 | MPB-750 | 8830-750-10 | 8831-750-10 | 8832-750-10 | 8833-750-10 | 8834-750-10 | 8835-750-10 |
| 0.770-0.789 | 19.56-20.07 | 0.765 | 19.43 | MPB-770 | 8830-770-10 | 8831-770-10 | 8832-770-10 | 8833-770-10 | 8834-770-10 | 8835-770-10 |
| 0.780-0.799 | 19.81-20.32 | 0.775 | 19.69 | MPB-780 | 8830-780-10 | 8831-780-10 | 8832-780-10 | 8833-780-10 | 8834-780-10 | 8835-780-10 |
| 0.800-0.819 | 20.32-20.83 | 0.795 | 20.19 | MPB-800 | 8830-800-10 | 8831-800-10 | 8832-800-10 | 8833-800-10 | 8834-800-10 | 8835-800-10 |
| 0.820-0.839 | 20.83-21.34 | 0.815 | 20.70 | MPB-820 | 8830-820-10 | 8831-820-10 | 8832-820-10 | 8833-820-10 | 8834-820-10 | 8835-820-10 |
| 0.840-0.859 | 21.34-21.84 | 0.835 | 21.21 | MPB-840 | 8830-840-10 | 8831-840-10 | 8832-840-10 | 8833-840-10 | 8834-840-10 | 8835-840-10 |
| 0.860-0.879 | 21.84-22.35 | 0.855 | 21.72 | MPB-860 | 8830-860-10 | 8831-860-10 | 8832-860-10 | 8833-860-10 | 8834-860-10 | 8835-860-10 |
| 0.880-0.899 | 22.35-22.86 | 0.875 | 22.23 | MPB-880 | 8830-880-10 | 8831-880-10 | 8832-880-10 | 8833-880-10 | 8834-880-10 | 8835-880-10 |
| 0.900-0.919 | 22.86-23.37 | 0.895 | 22.73 | MPB-900 | 8830-900-10 | 8831-900-10 | 8832-900-10 | 8833-900-10 | 8834-900-10 | 8835-900-10 |
| 0.920-0.939 | 23.37-23.88 | 0.915 | 23.24 | MPB-920 | 8830-920-10 | 8831-920-10 | 8832-920-10 | 8833-920-10 | 8834-920-10 | 8835-920-10 |
| 0.940-0.959 | 23.88-24.38 | 0.935 | 23.75 | MPB-940 | 8830-940-10 | 8831-940-10 | 8832-940-10 | 8833-940-10 | 8834-940-10 | 8835-940-10 |
| 0.960-0.979 | 24.38-24.89 | 0.955 | 24.26 | MPB-960 | 8830-960-10 | 8831-960-10 | 8832-960-10 | 8833-960-10 | 8834-960-10 | 8835-960-10 |
| 0.980-1.000 | 24.89-25.40 | 0.975 | 24.77 | MPB-980 | 8830-980-10 | 8831-980-10 | 8832-980-10 | 8833-980-10 | 8834-980-10 | 8835-980-10 |

* Plugs are only available in 10 packs.

Note: Elliott offers mechanical tube plugs to meet Nuclear ASME Sec. III or ISO 9002 QA specifications.

Additional sizes and materials are available upon request. A minimum order quantity may be applicable for these special sizes and materials. Contact Customer Service for details.

| Required Torque To Set Tube Plug | | | | | | | |
|----------------------------------|---------------|------|--------------|------|------------------------------------|------|-----------------------|
| Plug OD (Inches) | Brass & Cu-Ni | | Carbon Steel | | Stainless Steel, Titanium, & Monel | | Hex Drive (Inches) |
| | in lbs. | Nm | in lbs. | Nm | in lbs. | Nm | |
| 0.410-0.550 | 200 | 22.5 | 250 | 28.2 | 300 | 33.9 | 1/4 |
| 0.570-0.710 | 250 | 28.2 | 350 | 39.5 | 500 | 56.5 | 5/16 |
| 0.730-0.980 | 350 | 39.5 | 450 | 50.8 | 600 | 67.8 | 3/8 |

The range on the torque wrench is 120 – 960 in. lbs.



MECHANICAL TUBE PLUG

Accessories

Tube Preparation:

It is highly recommended to clean the tube end prior to plugging. This ensures the surface is free from debris and optimal for positive sealing.



24" Brush Extensions:

Great for reaching through an air cooler header box.

| Brush Range | Brush Extensions, 24" (609.6mm) |
|---------------------|---------------------------------|
| MPB-410 to MPB-570 | MPB-D0375-24 |
| MPB-590 to MPB-1000 | MPB-D0500-24 |

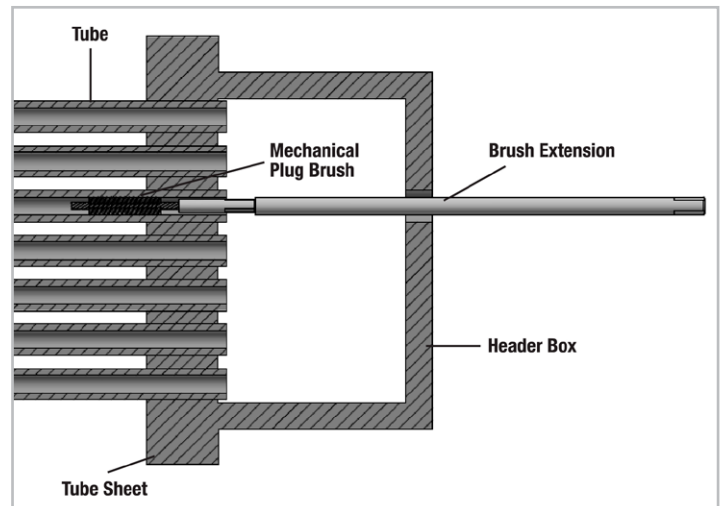

Plug Removal:

Elliott offers plug removal kits to easily remove Elliott's mechanical plugs.

| Measured Tube ID Range | Plug Removal Kits |
|--------------------------------------|-------------------|
| 0.410" - 0.569" (10.41 - 14.48mm) | 8800-312 |
| 0.570" - 0.709" (14.48 - 18.03mm) | 8800-375 |
| 0.710" - 1.000" (18.03 - 25.40mm) | 8800-500 |

Plug Removal Kit Includes:

- Threaded Rod
- Easy Out
- Slide Hammer
- Hex Jam Nut
- Fender Washer



HEADER PLUGS

Plug Size

- 0.750" to 1.625" OD
- 19.1mm to 41.3mm OD

Materials

- Stainless Steel
- Carbon Steel

Elliott's Header Plugs and Gaskets are designed for use in air cooled heat exchangers. Simply thread the plug and gasket into the plug hole of the header or water box before putting the vessel in operation.

Header Plugs and Gaskets are available in 316 Stainless Steel and Carbon Steel in a variety of sizes and under head lengths. Additional sizes and materials are available upon request.



Accessories:

- Anti-Seize Lubricant, P8788

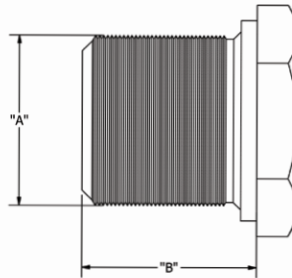

| Typical Tube OD | "A" Plug Diameter | UNF Thread | "B" Length Under Head | Header Plug, 10-Pack | | Gasket | | Hex Size |
|--------------------|--------------------|------------|-----------------------|-----------------------|----------------------|---------------|------------------|--------------------|
| | | | | Carbon Steel (SA-105) | Stainless Steel | Carbon Steel | Stainless Steel | |
| 5/8" (15.9mm) | 3/4" (19.05mm) | 16 | 1" (25.4mm) | HPCS750-1000-10 | HPSS316-750-1000-10 | HPG750-CS-10 | HPG750-SS316-10 | 1" (25.4mm) |
| 3/4" (19.05mm) | 7/8" (22.2mm) | 14 | | HPCS875-1000-10 | HPSS316-875-1000-10 | HPG875-CS-10 | HPG875-SS316-10 | 1-1/8" (28.6mm) |
| 7/8" (22.2mm) | 1" (25.4mm) | 12 | | HPCS1000-1000-10 | HPSS316-1000-1000-10 | HPG1000-CS-10 | HPG1000-SS316-10 | 1-1/4" (31.8mm) |
| 1" (25.4mm) | 1-1/8" (28.6mm) | | | HPCS1125-1000-10 | HPSS316-1125-1000-10 | HPG1125-CS-10 | HPG1125-SS316-10 | 1-3/8" (34.9mm) |
| 1-1/8" (28.6mm) | 1-1/4" (31.8mm) | | | HPCS1250-1000-10 | HPSS316-1250-1000-10 | HPG1250-CS-10 | HPG1250-SS316-10 | 1-1/2" (38.1mm) |
| 1-1/4" (31.8mm) | 1-3/8" (34.9mm) | | | HPCS1375-1000-10 | HPSS316-1375-1000-10 | HPG1375-CS-10 | HPG1375-SS316-10 | 1-5/8" (41.3mm) |
| 1-1/2" (38.1mm) | 1-5/8" (41.3mm) | | | HPCS1625-1000-10 | HPSS316-1625-1000-10 | HPG1625-CS-10 | HPG1625-SS316-10 | 1-7/8" (47.6mm) |

Contact Elliott for additional sizes and materials

| Required Torque To Set Plug | | | | |
|-----------------------------|---------------------------------|---------------------|------------------------|---------------------|
| Plug Diameter | C.S. Plug with Soft Iron Gasket | | SS and Alloy Gaskets | |
| | Target Torque (ft lbs) | Max Torque (ft lbs) | Target Torque (ft lbs) | Max Torque (ft lbs) |
| 1-1/8" | 250 | 400 | 400 | 550 |
| 1-1/4" | 300 | 450 | 425 | 600 |
| 1-3/8" | 350 | 500 | 450 | 650 |

If plugs leak, increase torque in increments of 25 ft. lbs. until seal is obtained.



STEPS, TYPES & IMPORTANCE

HEAT EXCHANGER TUBE PLUGS

Plugging tubes are one of the most convenient ways to repair shell-and-tube types of heat exchangers. It can be an effective and reliable method to fix a heat exchanger when done properly. However, it could cause more harm than good if not executed carefully.

The Importance Of Proper Plug Installation

As we mentioned before, if done correctly, tube plugs can be an effective way to prolong the life of a heat exchanger. However, if not done properly, it could cause many problems:

Creating new leaks: If the tube ID isn't cleaned properly or the plug isn't inserted correctly, it could cause a new leak to form.

Damage to the heat exchanger tubes: If the plug is inserted too forcefully, it could damage the tube or tube sheet coating, which would need to be replaced.

Increased pressure: If the tube is not vented prior to plugging it can cause the heat exchanger to become over pressurized, leading to many problems, including leaks, damage to the heat exchanger, and even explosions.

6 Steps For Effective Tube Plugging In Heat Exchangers

STEP 1- Identify the leaking tube. This can be done by looking for signs of corrosion and using a tube leak test gun. Once the leaking tube is found, it must be isolated from the other tubes in the heat exchanger.

STEP 2- Clean the ID of the tube where the plug will be installed. This includes removing any debris or corrosion that might be present.

STEP 3 – Vent the tube prior to plugging. Tube venting is a process by which a small puncture is made inside of the tube, releasing any pressure or chemicals that may be trapped inside. This reduces the risk of deposits filling the leak path and causing a build-up of pressure.

STEP 4- Once the area is cleaned, the tube can be plugged. There are a few different ways to do this, but one of the most common methods is to use a mechanical plug. This plug is inserted into the tube and then expanded to create a seal.

STEP 5- Once the plug is in place, it's important to check for leaks. This can be done by doing a pressure test on the heat exchanger.

STEP 6- If there are no leaks, the heat exchanger can be returned to service.



Tapered Plug:

A tapered pin or one-piece plug is installed by tapping the end into the tube using a hammer or mallet until metal-to-metal contact is made. This creates a tight seal but can crack the tube sheet or split the tube if installed improperly.



Ring & Pin:

This two-piece styled plug consists of a bushing (ring) that sits inside the tube and a tapered plug (pin) that is hammered in through the bushing. By adding the secondary ring you are increasing the sealing area of the plug.



Mechanical Plug:

Designed to expand inside the tube, creating a positive mechanical seal. The seal takes place inside the tube end so it can be used in higher pressure applications. The advantage of this method is that it can be done relatively quickly and does not cause damage to the tube or tube sheet.

A PROACTIVE GUIDE

INSTALLING MECHANICAL TUBE PLUGS

When needing to use and install mechanical tube plugs, having the correct tools for the job can make it easier and quicker to get the job done. This is a are step by step guide to help overcome this challenge.

CLEAN & PREP

Prior to any work being done it is important to brush the tube using Elliott's MPB brush sized properly for the tube ID. The MPB brush is a rigid steel wire brush that is designed to remove material from the tube to create a prime surface that the plug can seal against. The brush can be driven by a standard handheld drill. If the MPB brushes does not create a prime surface, an adjustable reamer can be used.

Please note the size and use caution to not over adjust the reamer and remove too much tube wall during this process. Elliott suggests that the adjustable reamer be driven by hand power only to avoid damage and control the reaming.



Adjustable Reamer, Image provided by MSC



Mechanical Plug Prep Brush

MEASURING

Elliott's Tube Hole Gauge can be ordered for a wide range of sizes and reaches to overcome any reach constraints. When using this tool, it is important to measure in the area that you plan to install the tube plug and ensure that after each measurement, rotate the gauge 5-10° to further check the tube for any tenting or irregular shapes. Be sure to log this information so that it can be tracked for quality assurance.

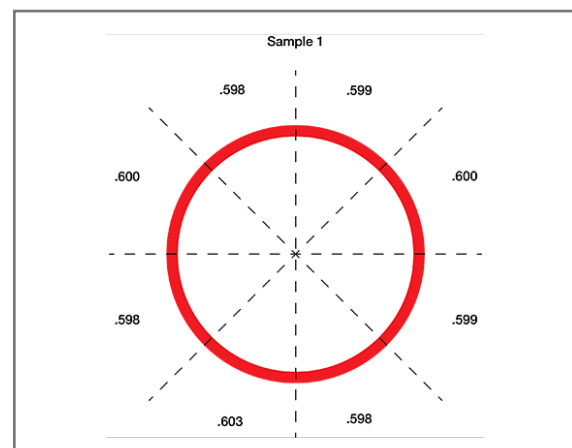

Tube ID Irregularities

VENTING

One of the most overlooked best practices for plugging a tube is to vent the tube beforehand. Tube venting is a process by which a small puncture is made inside of the tube, releasing any pressure or chemicals that may be trapped inside. Venting is highly recommended for oil refineries, petrochemical, chemical and other processes that utilize heat exchangers and feed water heaters. Certain chiller applications may specify otherwise, so it's best to check with your manufacturer.

To do this, we recommend using Elliott's One-Rev tube cutter. The vent should be beyond the tube sheet to ensure the tube does not build up pressure and create risk for plug dislodging, fire, or explosion. Venting can be done on both ends of the tube, as well as, on the top and bottom of the tube. This ensures that pressure cannot build-up later on due to corrosion or process fluids.

Determine how far down the tube you wish to make the cut and lock the collar in place.
Insert the cutter into the tube and start rotating the cutter clockwise.
When you begin to feel some resistance, rotate the tool a quarter turn more to pierce the tube.
Turn the cutter counter-clockwise to reset the cutter bit.
Once the bit is retracted, the cutter can be removed.



Elliott's One-Rev Tube Cutter

TUBE PLUGGING

Once the above has been completed, the operator can now choose the correct plug for the tube and application. Remember it's important to match like materials and to select the appropriately sized plug for the tube ID being plugged.

During installation you may find that you need accessories to reach through channels for water boxes. This will be dependent on the vessel and space constraints. Things to keep in mind:

- If using socket extensions, be aware that extreme reaches could result in slight loss in torque. Double check the torque value on a test stand to anticipate and account for any losses.
- Brush extension kits are available from Elliott to ensure you can reach through headers, water boxes, and channels to clean the tube end.
- Air coolers pose a unique challenge as a 12' reach expander could be needed to expand the tube past the tube sheet so that the eccentric cam has room to lock into place during installation.

To install the plug, select the correct size and place the plug on the end of the provided hex key until you hear a slight 'snap'. This indicates that the plug is secure. When positioning the plug, be sure that the serrated portion of the plug lands within the tube sheet area. This will ensure that the plug seals against the tube and tube sheet to allow for optimal performance. If the serrated area lands outside of the tube sheet area, the plug and torque wrench could reach torque but during testing and operation, the plug could come loose and leaks would be present.

Once the plug is placed in the appropriate spot, take your torque wrench and start turning until torque increases. Elliott recommends the use of a digital torque wrench that features color, audio, and vibration alerts when you meet your desired torque. Once you reach the desired torque, stop applying force and remove the hex key from the plug and repeat this process for the next tube.

REMOVE



CONTENTS

| | |
|---------------------------------|-----|
| One-Revolution Tube Cutter..... | 190 |
| Push Type Tube Cutter | 192 |
| Boiler Tube Cutter | 194 |
| Standard Cutter Inserts | 195 |
| SpeedCut | 198 |
| Hydraulic Pumps..... | 202 |
| Collet Tube Puller | 203 |
| Super Collet Tube Puller..... | 204 |
| Cyclgrip | 207 |
| Tube Tugger..... | 208 |
| Super Tube Tugger | 209 |
| Tapping Spears | 212 |
| TT Tube Spears | 214 |
| Stub Tugger..... | 216 |
| Manual Tube Puller..... | 218 |
| E-Series Hex Spears | 219 |
| Pneumatic Hammer..... | 221 |
| 430G Series..... | 222 |
| Wall-Reducing Tools..... | 223 |
| 430D Series | 224 |
| Knockout Tools..... | 225 |

AVOIDING COMMON PITFALLS OF TUBE EXTRACTION

Tube removal can be a daunting task, especially when encountering challenges like corrosion or tight spaces. One of the most frustrating situations operators face is the inability to pull a tube using a hydraulic puller. This article explores the four primary reasons behind this issue and offers simple solutions to overcome them.

WHY WON'T THIS TUBE PULL?

- Tube isn't cut on the other side
- Seal or strength weld has not been removed
- Wrong size or worn-out tooling
- Extreme corrosion

Tube Isn't Cut

A common oversight in tube removal is failing to cut the tube on the opposite side behind the tube sheet. This is particularly easy to miss when removing multiple tubes or sections. To prevent delays due to missed tubes, it's recommended to check that all tubes in the removal area have been successfully cut through on the other side prior to pulling.

Weld Hasn't Been Removed

With many manufacturers opting for seal or strength welds, welded tubes have become extremely common. While they are beneficial for the vessel when in operation, they can make tube removal much more time consuming. In order to remove a welded tube, the weld must first be removed.

One of the best methods for weld removal is to use an end prep tool, also known as a tube auger, boiler gun, or mill hog. This tool uses a collet jaw to grip the inside of the tube while the operator advances the blade until the weld is fully removed.

Wrong Size Or Worn-Out Tool

When using a pulling spear, the ID of the tube is critical. If the spear is undersized for the tube, you will see it bottom out when being driven into the tube. This means it will go in the tube a quarter or halfway (up to the shoulder) before being driven in with an impact. If a spear is too small, the teeth won't be able to bite into the tube material enough to break the mechanical joint.

If the spear is oversized it will be difficult to drive it into the tube. This means that it will require more force to drive it into the tube with an impact and it won't be able to grip the tube effectively. Instead, this will result in spear breakage where the very end will snap off in use.

In addition to improper spear sizing, the inability to remove the tube can also be related to worn-out tooling. This can mean that the teeth of the spear are worn down and have lost their ability to grip the material. It can also mean that the collets are worn out and are not grabbing the spear or tube in the hydraulic puller itself. Many customers will know the collet set is worn out when they feel they need additional leverage to pull the tube.

Too Much Corrosion

In certain petrochemical applications, the hot pass side of an exchanger can see extensive corrosion due to temperature and caustic materials. If the tube is too worn and brittle, it will be very challenging to remove the tube with a spear. This will be evident if the tube breaks or fractures into pieces when trying to pull. In these situations, it's preferred to pull the tube from the back or punch them out with a knockout tool.

By understanding and addressing the common tube removal challenges outlined in this article, operators can significantly improve efficiency and reduce downtime. Proper tool selection and adherence to best practices are essential for successful tube extraction. By investing in training and staying updated on the latest techniques, operators can ensure that tube removal remains a smooth and efficient process.

By carefully considering these factors, you can select the most appropriate tube cleaning method to effectively remove deposits and maintain vessel performance. For more information on selecting the right cleaning tool, contact our Application Specialist Team.



Figure 1. Example of failing to cut the tube on the opposite side behind the tube sheet

9060 SERIES

One-Revolution Tube Cutter

Tube Size

- 0.375" to 2.500" OD
- (9.525 to 63.5mm) OD



LET THE REVOLUTION BEGIN.

Elliott's 9060 One-Revolution Series tube cutters are unlike any other one-revolution cutter. Using more advanced engineering principles the cutter and blade have been designed to last longer, withstand more wear and require less force to cut the tube.

Elliott's One-Rev is for hand use only with the employment of a ratchet or wrench. The 9060 One-Revolution Series tube cutters can be used for both cutting a tube for removal and puncturing the tube for venting prior to plugging.

The One-Revolution Tube Cutter is available in have a 6" (152.4mm) & 12" (304.8mm) reach. The Cutting Blades are manufactured from premium quality tool steel. For longer reach cutters, contact Customer Service for details.

Features & Benefits:

- Increased tool life - engineered to last longer than any other cutter and blade.
- Quick setup and use - greater productivity.
- Hex head drive - lower capital investment for drive motor.

Spares & Accessories:

- Cutter Blade
- Cutter Pin
- Cutter Lubricant: P8790A for 4 oz (0.118 liter) or P8790B for 1.000 gallon (3.785 liter). Recommended to maximize cutter blade life when applied to blade.

9060 One-Revolution Series Tube Cutter includes:

- Cutter Blade
- Cutter Pin



“ Using the 2 one rev cutters Elliott provided, our guys vented 128 1" x 0.134 Wall (10 BWG) tubes without breaking a single cutting blade.

Mike Menze

General Superintendent, CIMS Ltd.



Visit Our YouTube Channel To See the One-Rev in action!

www.youtube.com/elliott-tool



9060 SERIES

One-Revolution Tube Cutter

| Tube OD Range | BWG | Body OD | | Part # | | Drive Shank Size | Cutter Blade | Cutter Pin |
|-----------------|--------|---------|------|----------|-------------|------------------|--------------|------------|
| | | Inch | mm | 6" Reach | 12" Reach | | | |
| 3/8" (9.5mm) | 18 | 0.272 | 6.9 | 9060-050 | - | 7/32" Hex | 9060N375-1 | 9060P5 |
| 1/2" (12.7mm) | 18-19 | 0.394 | 10.0 | 9060-100 | 9060-100-12 | 5/16" Hex | 9060N500-1 | |
| | 20 | 0.425 | 10.8 | 9060-108 | 9060-108-12 | | | |
| 5/8" (15.9mm) | 14 | 0.445 | 11.3 | 9060-113 | 9060-113-12 | 3/8" Hex | 9060N625-3 | 9060P1 |
| | 15-16 | 0.469 | 11.9 | 9060-119 | 9060-119-12 | | | |
| | 17-18 | 0.484 | 12.3 | 9060-123 | 9060-123-12 | 7/16" Hex | 9060N625-2 | |
| | 19-21 | 0.516 | 13.1 | 9060-131 | 9060-131-12 | | 9060N750-2 | |
| | 22 | 0.547 | 13.9 | 9060-139 | 9060-139-12 | | | |
| 3/4" (19.1mm) | 10-11* | 0.461 | 11.7 | 9060-117 | 9060-117-12 | 3/8" Hex | 9060N750-1 | 9060P2 |
| | 12-13 | 0.516 | 13.1 | 9060-131 | 9060-131-12 | 7/16" Hex | 9060N750-2 | |
| | 14-15 | 0.571 | 14.5 | 9060-145 | 9060-145-12 | 1/2" Hex | | |
| | 16 | 0.594 | 15.1 | 9060-151 | 9060-151-12 | | | |
| | 17-18 | 0.602 | 15.3 | 9060-153 | 9060-153-12 | | | |
| 7/8" (22.2mm) | 12-13 | 0.642 | 16.3 | 9060-163 | 9060-163-12 | 5/8" Hex | 9060N1000-1 | 9060P3 |
| | 14-15 | 0.685 | 17.4 | 9060-174 | 9060-174-12 | | | |
| | 16-17 | 0.724 | 18.4 | 9060-184 | 9060-184-12 | | | |
| | 18 | 0.748 | 19.0 | 9060-190 | 9060-190-12 | | | |
| | 19-20 | 0.760 | 19.3 | 9060-193 | 9060-193-12 | | | |
| 1" (25.4mm) | 10* | 0.685 | 17.4 | 9060-174 | 9060-174-12 | 3/4" Hex | 9060N1000-1 | 9060P3 |
| | 11 | 0.724 | 18.4 | 9060-184 | 9060-184-12 | | | |
| | 12-13 | 0.760 | 19.3 | 9060-193 | 9060-193-12 | | | |
| | 14 | 0.807 | 20.5 | 9060-205 | 9060-205-12 | | | |
| | 15 | 0.827 | 21.0 | 9060-210 | 9060-210-12 | | | |
| | 16-17 | 0.846 | 21.5 | 9060-215 | 9060-215-12 | | | |
| 1-1/4" (31.8mm) | 16-17 | 0.878 | 22.3 | 9060-223 | 9060-223-12 | 7/8" Hex | 9060N1000-2 | 9060P3 |
| | 22 | 0.913 | 23.2 | 9060-232 | 9060-232-12 | | | |
| | 10-11 | 0.965 | 24.5 | 9060-245 | 9060-245-12 | | | |
| | 12 | 1.004 | 25.5 | 9060-255 | 9060-255-12 | | | |
| | 13-14 | 1.039 | 26.4 | 9060-264 | 9060-264-12 | | | |
| 1-1/2" (38.1mm) | 15-16 | 1.079 | 27.4 | 9060-274 | 9060-274-12 | 7/8" Hex | 9060N1000-2 | 9060P3 |
| | 17-19 | 1.114 | 28.3 | 9060-283 | 9060-283-12 | | | |
| | 20-24 | 1.160 | 29.5 | 9060-295 | - | | | |
| | | | | | | | | |

| Tube OD Range | BWG | Body OD | | Part # | | Drive Shank Size | Cutter Blade | Cutter Pin |
|-----------------|-------|---------|----------|----------|-------------|------------------|--------------|------------|
| | | Inch | mm | 6" Reach | 12" Reach | | | |
| 1-1/2" (38.1mm) | 10-11 | 1.217 | 30.9 | 9060-309 | 9060-309-12 | 7/8" Hex | 9060N1500-1 | 9060P3 |
| | 12-13 | 1.260 | 32.0 | 9060-320 | 9060-320-12 | | | |
| | 14-15 | 1.311 | 33.3 | 9060-333 | 9060-333-12 | | | |
| | 16-17 | 1.335 | 33.9 | 9060-339 | 9060-339-12 | | | |
| | 18-19 | 1.378 | 35.0 | 9060-350 | 9060-350-12 | | | |
| 1-3/4" (44.5mm) | 10-11 | 1.453 | 36.9 | 9060-369 | - | 1" Hex | 9060N1500-1 | 9060P3 |
| | 12-14 | 1.508 | 38.3 | 9060-383 | - | | | |
| | 15-16 | 1.587 | 40.3 | 9060-403 | - | | | |
| | 17-18 | 1.614 | 41.0 | 9060-410 | - | | | |
| 2" (50.8mm) | 10 | 1.713 | 43.5 | 9060-435 | 9060-435-12 | 1" Hex | 9060N1500-1 | 9060P3 |
| | 11 | 1.740 | 44.2 | 9060-442 | - | | | |
| | 12-13 | 1.760 | 44.7 | 9060-447 | 9060-447-12 | | | |
| | 14-15 | 1.799 | 45.7 | 9060-457 | - | | | |
| | 16-17 | 1.843 | 46.8 | 9060-468 | - | | | |
| 2-1/4" (57.2mm) | 18-19 | 1.874 | 47.6 | 9060-476 | 9060-476-12 | 1 1/4" Hex | 9060N2250-1 | 9060P4 |
| | 10 | 1.957 | 49.7 | 9060-497 | - | | | |
| | 11 | 1.988 | 50.5 | 9060-505 | - | | | |
| | 12-13 | 2.012 | 51.1 | 9060-511 | - | | | |
| | 14-15 | 2.063 | 52.4 | 9060-524 | - | | | |
| 2-1/2" (63.5mm) | 16-17 | 2.098 | 53.3 | 9060-533 | - | 1 1/4" Hex | 9060N2250-1 | 9060P4 |
| | 18-19 | 2.130 | 54.1 | 9060-541 | - | | | |
| | 10 | 2.213 | 56.2 | 9060-562 | - | | | |
| | 11 | 2.240 | 56.9 | 9060-569 | - | | | |
| | 12-13 | 2.252 | 57.2 | 9060-572 | - | | | |
| | 14-15 | 2.303 | 58.5 | 9060-585 | - | | | |
| | 16-17 | 2.346 | 59.6 | 9060-596 | - | | | |
| 18-19 | 2.370 | 60.2 | 9060-602 | - | | | | |

ONE-REVOLUTION TUBE CUTTER

* Intended for puncturing only, cannot be used to cut tubes.
 NOTE: Some thick wall tubes cannot be cut with the One-Rev cutter, but can still be punctured. This is due to the large material ribbon that is produced during cutting that can catch on adjacent tubes, preventing the cutter from fully rotating.



PTTC SERIES

Push Type Tube Cutter

Tube Size

- 0.375" to 2.500" OD
- (9.5 to 63.5mm) OD



Elliott's PTTC (Push Type Tube Cutter) Series Cutters accommodate heat exchangers and boilers with tube OD sizes 0.375" to 2.500" (9.5 to 63.5mm) with tube sheets 5" (127.0mm) to 12" (304.8mm) thick. The adjustable collar allows tubes to be cut or scored just beyond the tube sheet. The cutting blades are specially coated to increase longevity. Elliott offers two blade styles for Non-Ferrous Steel and Stainless Steel to achieve optimum cutting efficiency.

Each PTTC Tube Cutter Assembly is supplied with an installed blade, complete pilot set, and Allen wrenches.* The 1/2" hex drive shank on cutters up to 1" OD allows the use of common Jacobs drill chucks for driver connection. 1-1/4" to 2-1/2" OD cutters require a 3/4" square drive and adapter.

*The 3/8" (9.5mm) PTTC Tube Cutter Assembly does not require pilots.

Features & Benefits:

- Quick setup and use - greater productivity.
- Includes complete pilot set for wide range of gauges - lower tooling expense.
- Hex head drive on cutters up to 1" OD - lower capital investment for drive motor.

PTTC Series Tube Cutter Kits include:

- Tube Cutter
- Cutter Blades with Pin
- Tube Cutter Pilots (For sizes 5/8" to 2-1/2" (15.9mm to 63.5mm))



Spares & Accessories:

- Non-Ferrous/Steel Cutter Blades
- Stainless Steel Cutter Blades
- Cutter Lubricant: P8790A for 4 oz (0.118 liter) or P8790B for 1.000 gallon (3.785 liter). Recommended to maximize cutter blade life when applied to blade.
- Electric and Pneumatic Tube Cutter Drive Motors:
 - Morse Taper Adapter: Included with Electric Drive Motor
 - Drive Socket: Included with Electric Drive Motor
 - Jacobs Chuck



| Tube OD | Cutter Kit # (Includes Pilot Set) | | Drive Shank Size | Non-Ferrous/ Steel Blade with Pin | Stainless Steel Blade with Pin | *Cutter Pin # | Number of Pilots in a Set | Tube Gauge Sizes for Pilot |
|---------------------|--------------------------------------|-------------|------------------|--------------------------------------|--------------------------------|---------------|---------------------------|----------------------------|
| | 5" Reach | 12" Reach | | | | | | |
| 3/8" (9.53mm) | PTTC375-22** | - | 1/2"Hex | PTTC25210 | - | PTTC375-22D10 | ** | 22-24 |
| 5/8" (15.9mm) | PTTC625K | PTTC625K12 | | PTTC25186 | PTTC25186S1 | PTTC625CP | 3 | 16-22 |
| 3/4" (19.1mm) | PTTC750K | PTTC750K12 | | PTTC25186-1 | PTTC25186S2 | PTTC750CP | 4 | 14-22 |
| 7/8" (22.2mm) | PTTC875K | PTTC875K12 | | PTTC25194 | PTTC25194S1 | PTTC875CP | 5 | 12-22 |
| 1" (25.4mm) | PTTC1000K | PTTC1000K12 | | PTTC25199 | PTTC25199S1 | PTTC1000CP | | |
| 1-1/4" (31.8mm) | PTTC1250K | PTTC1250K12 | 3/4" Sq | PTTC25206 | PTTC25206S1 | PTTC1250CP | 4 | 12-19 |
| 1-1/2" (38.1mm) | PTTC1500K | PTTC1500K12 | | PTTC25206-1 | PTTC25206S2 | PTTC1500CP | | 10-17 |
| 1-3/4" (44.45mm) | PTTC1750K | PTTC1750K12 | | | | PTTC25206CP | 3 | 12-17 |
| 2" (50.8mm) | PTTC2000K | PTTC2000K12 | | PTTC25221 | PTTC25221S1 | PTTC2000CP | 5 | 10-14 |
| 2-1/4" (57.2mm) | PTTC2250K | PTTC2250K12 | | PTTC25222 | PTTC25222S1 | PTTC25222CP | | |
| 2-1/2" (63.5mm) | PTTC2500K | PTTC2500K12 | | PTTC25223 | PTTC25223S1 | PTTC2500CP | | |

NOTE: Kits for OD sizes 1" and larger include 2 blades.

*Included with cutter blade but can be purchased separately.

**The 3/8" (9.5mm) PTTC Tube Cutter Assembly does not require pilots. To be used only with P5154 drive motor.

Elliott's Tube Cutter Drive Motors are used to power the PTTC Series Tube Cutter. They are available in both electric and pneumatic models to suit your application needs.

| Motor Specifications | | | | | |
|----------------------|-------------|-----------------|-------------------|-----------------|----------------|
| Motor | OD Range | Motor Type | RPM | Requirements | Weight |
| P5154 | 3/8"-1" | Pneumatic | 325 | 23 CFM @90 PSI | 5.5lbs (2.5Kg) |
| P5476C* | 1-1/4" & Up | Pneumatic | 190 | 70 CFM @90 PSI | 13 lbs (5.8Kg) |
| 447000 | 3/8"-2 1/2" | Electric (110V) | 60-140 200-470 | 50/60Hz, 16 Amp | 16lbs (7.3Kg) |
| 447000-220 | 3/8"-2 1/2" | Electric (220V) | 60-140 200-470 | 50/60Hz, 8 Amp | 16lbs (7.3Kg) |

*Motor P5476C requires 3/4" Jacobs Chuck (P5476CH) for operation



447000 & 447000-220 electric motors include:

- 5/8" (15.9mm) Jacobs Chuck
- 3/4" (19.1mm) Square Female Socket Adapter
- Morse Taper Adapter

P5154 & P5476C pneumatic motors include:

- 1/2" (12.7mm) Jacobs Chuck

Spares & Accessories:

- 830-12-3-075 Morse Taper Adapter
- 71S0C 3/4" (19.1mm) Square Female Socket Adapter
- 4470JA Jacobs Chuck for the 447000 and 447000-220 electric motors
- 40-80700021-2 Spare Carbon Brush Set for the 447000 and 447000-220 electric motors
- P5476CH Jacobs Chuck for the P5154 and P5476C pneumatic motors



REPORTS 10X MORE LIFE THAN EGI SPEARS



QUICK SUMMARY

The Challenge

- Turn around vessels quickly with high customer satisfaction.
- Poor performance and inconsistent quality from EGI spears was hindering production.

The Solution

- Trial Elliott's E-Series hex spears to compare quality and performance.

The Results

- Tool life was 10x better with Elliott.
- Reduced downtime due to spear breakage.
- Improved productivity.

The Challenge

A chemical plant and international leader in the production of nylon, plastics and synthetic fibers has a large fabrication shop located in southern U.S.A that provides maintenance and creation of new vessels.

The shop manager is challenged with eliminating wasted labor and increasing production. Working on as many as three vessels at once, the fabrication shop must manage its time and resources well to maintain quick turnaround and customer satisfaction. Part of their maintenance work includes tube removal. The preferred method of removal is to manually pull tubes with spears. The fabrication shop was previously using EGI spears because of their lower price but had noticed poor tool performance and inconsistencies in tool life.

The EGI spears would often break down on the pulling teeth or snap in two pieces, sometimes after only pulling one or two tubes.

The Solution

The fabrication shop chose to test Elliott E-Series hex spears because they can withstand 2,500 more ft/lb of force exerted upon them than the EGI spears. Their engineered design lowers the chance that the gripping end of the spear will break off in the tube, saving time, money and hassle.

In order to determine if this tooling choice would be the right fit, the shop manager tested Elliott E-Series hex spears versus EGI spears side by side on 1.250" 11 BWG stainless steel tubes.

The Results

The fabrication shop significantly reduced their tooling costs and labor by using Elliott's E-Series hex spears.

Elliott's E-Series hex spear tool life was much greater during the testing, pulling more than 10 times the amount of the EGI spears and consistently pulling over 50 tubes each. The Elliott hex spears provide the tool life needed by the fabrication shop, with no downtime since their engineered design lowers the chance of the spear breaking off in the tube, eliminating wasted labor and increasing their production.

The EGI spears consistently pulled less than 5 tubes. Every time an EGI spear broke inside the tube, operators needed to spend 15-20 minutes to remove the spear and start the process again, greatly decreasing efficiency. "We pulled 10 times as many tubes with Elliott's spears, eliminating wasted labor and increasing our production," noted the shop manager.

Considering a similar job with 500 tubes, using Elliott E-Series hex spears would eliminate 25 hours in downtime due to spear breakage and save over \$15,000 in tooling cost.



| | Number of Tubes to be Pulled | Number of Spears Needed | Approximate Cost of Spears |
|-----------------------------|------------------------------|-------------------------|----------------------------|
| Elliott E-Series Hex Spears | 500 | 10 | \$1,860 |
| EGI Spears | 500 | 12 | \$17,500 |



We pulled 10 times as many tubes with Elliott's spears, eliminating wasted labor and increasing our production.

Pete Dunn Jr
President

300 SERIES

Boiler Tube Cutter

Tube Size

- 2.000" to 3.000" OD
- (50.8 to 76.2mm) OD



Elliott's 376 / 396 Series Boiler Tube Cutters are power driven to cut tubes in firetube and watertube boilers. The Series' primary purpose is to cut tubes to length on the common end of a firetube boiler. It is extremely important to cut tubes to a uniform length prior to beading the tubes with a roll beading expander.

The 376 / 396 Boiler Tube Cutters have a 1" (25.4mm) male square drive that is easily adapted to tube rolling motors that are 150 RPM or less. The cutters may also be employed with a ratchet for applications in space restricted areas.

The wheel style boiler cutters are designed to have a long tool life, giving you years of trouble-free service.

Features & Benefits:

- Rugged tool design - long tool life.
- Places tube to length before rolling - reduces operator error.
- Creates a non-abrasive cut which:
 - Eliminates prep time - less labor costs.
 - Operator can easily insert new tubes - less labor costs.
- Cuts tubes chip-free so no need to clean out vessel - less labor costs.

Spares & Accessories:

- Cutter Blade
- 37419P20000 Cutter Pin
- Feed Wedge
- 374170-20000 Feed Rod
- Drive Motors: Low RPM (≤ 150) motors are highly recommended for use with boiler tube cutters. Options include 447000 - See page 191, -90 right angle motors (see page 74), or 99300 series motors (see page 60).
- Drive Socket required for use with Drive Motor. See page 77 for more information.

Boiler Tube Cutter includes:

- Cutter Wheel
- Cutter Pin
- Feed Wedge
- Feed Rod

| Tube OD | | BWG | Tube Cutter Part # | Weight | | Cutter Wheel | Cutter Pin | Feed Wedge |
|---------|------|-------|--------------------|--------|------|--------------|-------------|--------------|
| Inch | mm | | | Lbs. | Kg. | | | |
| 2" | 50.8 | 10-16 | 376-00-20000 | 15 | 6.8 | 374190-20000 | 37419P20000 | 374180-20000 |
| 2-1/2" | 63.5 | 10-16 | 376-00-20102 | 18 | 8.2 | 374190-20104 | | 375FW30000 |
| 3" | 76.2 | 10-16 | 396-00-30000 | 40 | 18.2 | | | |



EXPERT TIPS

CHOOSING THE RIGHT TUBE PULLER

Despite the various options out there, not every application is equal. What works in a shell & tube heat exchanger might not work in a firetube boiler. Evaluating your application is going to allow you to choose the most effective solution.

Boilers

In general, boilers are not the most compatible with hydraulic pullers, unless following the Induction Heating method. This is because many tubes are often expanded behind the tube sheet or drum, requiring more force to break the mechanical joint. Additionally, boilers are more prone to warping, extreme wear, and often have grooved tube sheet holes. All these factors make it extremely challenging to pull tubes using a traditional spear and hydraulic puller set-up.

In cases where the tube stub is easily accessible and the condition isn't extreme, a stub style hydraulic puller could be used to pull stubs from the tube sheet or drum, in addition to starting the pulling process on the tube side. However, knockout tools, torching, and Induction Heating would be the most recommended options for boiler tube removal.

Chillers

As chiller tubes are often Copper material, the amount of force required for removal is lower. In these applications, speed of removal is generally more important than power. Cutting at the center tube sheet allows for tubes to be pulled quickly using a collet style puller and semi continuous Cyclgrip, which is able to clamp on to the tube and pull the entire tube out of the tube sheet.

A lot of times if the tube end is free of the tube sheet operators can pull out by hand.

Heat Exchangers

Heat exchanger applications have a lot more options for hydraulic pullers, as the size of the tubes makes it easier to pull tubes from the tube sheet regardless of wear. However, tube sheet grooves can make the process a bit more challenging and will require a high-power hydraulic ram to break the tube-to-tube sheet joint. In these applications, it's typically recommended to use a combination of collet style pulling and spear pulling, to remove both the tube stub and longer tube.

If necessary, a manual puller could be used in scenarios where only a few tubes need removed. Manual pulling is generally not recommended for larger jobs, as it takes a lot longer and isn't very ergonomic.



TUBE END MILL

Tube End Mill & Preparation Tool

COMING 2026

PERFORMANCE & DURABILITY FINALLY TOGETHER

Elliott's all new Tube End Mill delivers fast and precise tube end preparation for 3/4" – 1-1/2" tube and pipe applications.

Ideal for tube end trimming, seal and strength weld removal, and tube sheet hole beveling, the Tube Mill delivers optimal performance in the toughest applications.

The robust locking and feed system allows for faster setup and prevents premature tool breakage, significantly reducing downtime and cost per cut.

Maximize tool life on exotic materials with the standard AlCrN coated cutting blades. This new coating provides superior heat resistance and wear protection, delivering extended service life compared to traditional TiN coating.

Features & Benefits

Rugged Locking Mechanism

Durable design prevents premature tool breakage and wear, reducing downtime and cost.

Ease of Set-Up

System is easy for operators to set-up and use. Simply set in the tube or tube sheet hole, engage the locking system, and feed the cutting end forward.

Longer Life On Exotic Materials

Get better tool life on trimming exotic materials with AlCrN coated cutting inserts. Optimized for high temperature applications, they provide longer life without the use of cutting oil or lubricant.

Consistent Trimming Every Time

The adjustable collar allows for consistent tube trimming every time, eliminating downtime from manual checks. Simply flip the collar to switch between a flush or 1/8" tube projection.

Faster Tooling Change-Outs

Quickly swap out holders, bits, and locking sizes with minimal screws and little to no disassembly.

Convenient Compatibility

Holders and cutting inserts are designed to be compatible with Kraiss® for convenient use of existing systems

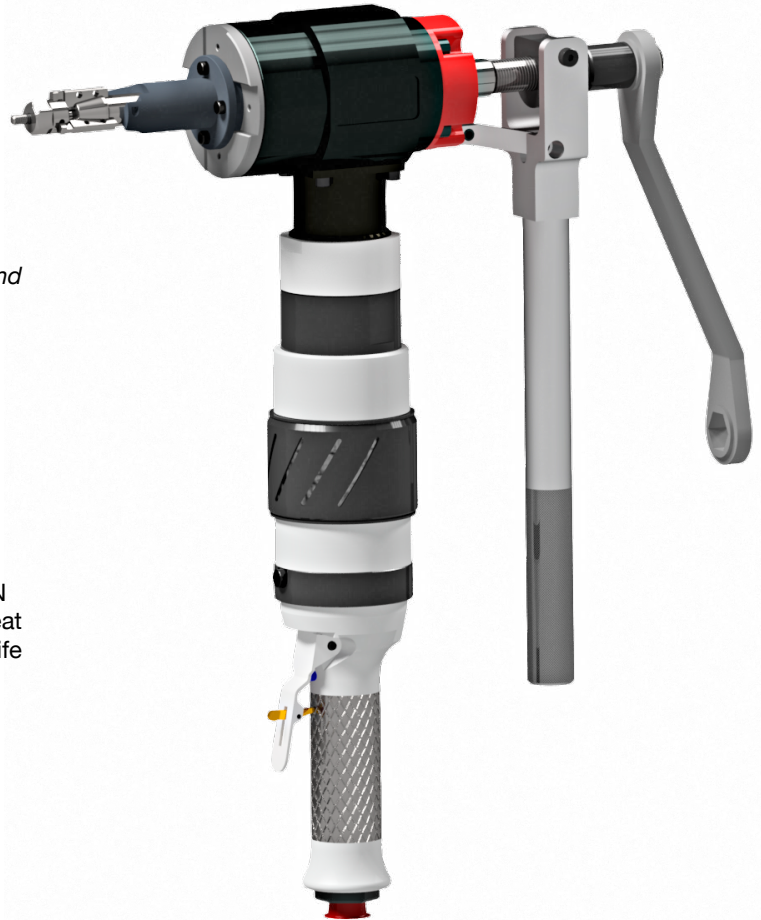

Spares & Accessories

- Fixed Cutting Holders: Strength weld, seal weld, trimming
- Cutting Inserts
- Locking mechanism: Cage, Retainers, and Jaws

Specifications

| System PN | Feed Type | Locking Type | Free Speed RPM | Air Usage |
|-----------|-----------|--------------|----------------|-----------------|
| TMS090L | Lever | Ratchet | 90 | 55 cfm @ 90 PSI |
| TMS090R | Wheel | | | |
| TMS090W | Wheel | | | |

Note: Other feed and locking options are available upon request.



TUBE END MILL

Spares & Accessories



Strength Weld Bit - AICrN



Tube Facing Bit - AICrN

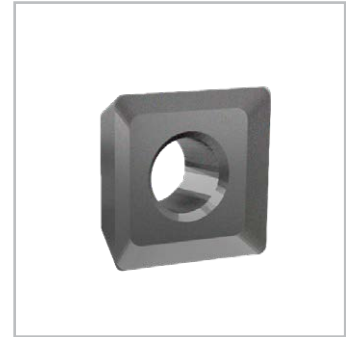

Tube Facing Bit - Carbide

| Locking System | | |
|-----------------|-----------------|---------|
| Tube ID Range | Cage & Retainer | Jaw Set |
| 0.500" – 0.635" | TML500 | TMJ500 |
| 0.625" – 0.760" | TML875 | TMJ625 |
| 0.750" – 0.885" | | TMJ750 |
| 0.875" – 1.010" | TML875 | TMJ875 |
| 1.000" – 1.135" | | TMJ1000 |
| 1.125" – 1.260" | | TMJ1125 |
| 1.250" – 1.385" | | TMJ1250 |
| 1.375" – 1.510" | | TMJ1375 |

| Holders & Projection Collars | | |
|------------------------------|--|----------------------|
| Tube OD | Tube Facing Holder & Projection Collar | Strength Weld Holder |
| 3/4" | TFH0750-125 | SWH-0750 |
| 7/8" | TFH0875-125 | SWH-0875 |
| 1" | TFH1000-125 | SWH-1000 |
| 1-1/8" | TFH1125-125 | SWH-1125 |
| 1-1/4" | TFH1250-125 | SWH-1250 |
| 1-1/2" | TFH1500-125 | SWH-1500 |

| Bits | | | | |
|------------------------|-------------------|---------------------|--------------------|--------|
| Application | Bit Part Number | Vertical Width | Horizontal Width | Screw |
| Tube Trimming / Facing | TFB500-500-CB | 0.197" (5.00mm) | 0.197" (5.00mm) | MTS-20 |
| | TFB630-950-AICrN | 0.248" (6.30mm) | 0.374" (9.50mm) | MTS-25 |
| | TFB950-950-AICrN | 0.374" (9.50mm) | 0.374" (9.50mm) | MTS-40 |
| Strength Weld Removal | SWB1350-950-AICrN | 0.531" (13.50mm) | 0.374" (9.50mm) | |



SPEEDCUT

Tube Bundle Cutter

CUT TOUGH JOBS DOWN TO SIZE.

Equipped with a rugged Baldor® Motor and the highly productive Automatic Cutting Force Control, Elliott's SpeedCut is a quick and cost effective way to cut through tube bundles and shells in a single pass.

It features a heavy-duty frame and powerful drivetrain to withstand the rigors of a production environment. Safe and efficient operation is possible without the need for a constant attendant.

The unit offers Automatic Cutting Force Control as a standard feature. The cutting cross section of the vessel is smaller at the top and bottom rows because there are fewer tubes per row. During larger portions of the cutting cycle the saw feed automatically pauses while maintaining constant cutting force. The result is that overall cutting time is reduced without sacrificing blade life.

Setup is easy. Simply position and secure the tube bundle to the Tube Sheet Support Table (an optional Bundle Support Table is available to support the rest of the bundle). If necessary the operator can adjust the blade tension with a simple torque wrench. Minimal attendance by the operator of the unit is enabled by three control systems that constantly monitor the cutting cycle. Should the blade break or stall, the system automatically stops the blade.

An MQL (Minimum Quantity Lubricant) Mist Lubrication System is a standard feature on the SpeedCut. A very thin film of lubricant is spread on the teeth of the blade just before the blade contacts the tube. As the heat from the cut is absorbed by the lubricant, the liquid is dissipated from the blade and the resulting chip. Environmental hazards and disposal costs are minimized, the cutting speed is increased, and the blade life is prolonged.



SPEEDCUT

Tube Bundle Cutter



Features & Benefits:

- The Hydraulic Feed Rate Control combined with the Automatic Cutting Force Control optimizes saw feed while maintaining consistent cutting force.
- Powerful 7.5 HP or 10 HP Baldor® Blade Drive Motor quickly cuts through a wide variety of tough materials.
- Heavy Duty Cone Drive® gearbox with powerful “Double Enveloping”® gear set for increased torque.
- Low voltage operator controls front mounted and easily accessible to operator.
- Remote Pedestal Control Console for added safety and convenience.
- Convenient digital band speed display.
- Control Legend Plates in English or Spanish (other languages available upon request).
- Hour Meter: Allows for more precisely scheduled preventative maintenance which lowers operating costs.
- Includes Machine Leveling Bolts.
- Three control systems and Blade Break/Stall Proximity Switch features enable safe unattended operation.
- Overload and under voltage protection.
- Maintenance Lockout for operator safety and protection during maintenance.
- MQL Mist Lubrication System to minimize disposal costs and prolong blade life.
- Tube Sheet Support Table & Ratchet Straps: Helps to secure the bundle during cutting operation.
- Rotary Blade Brush cleans and extends blade life.

Spares & Accessories:

- Bi-Metal Bandsaw Blades: Long-life, high quality blades for most materials, including copper, stainless steel and exotic materials.
- Clamp System: Allows for improved stability of the tube sheet during the sawing process and an added measure of safety for the crew and the machine.
- Bundle Support Table: Provides support for the end of the bundle while the other side is cut.
- MQL System Lubricant: Specially formulated for use with the SpeedCut.
- Recommended Spares Kit: Includes spare maintenance parts for quick replacement and no downtime. Includes: Blade Brushes, Drive Belt, Gear Oil, Bearings, Fuses, Roller Axles, and Roller Supports.



SPEEDCUT

Tube Bundle Cutter

TUBE BUNDLE CUTTER



Automatic Cutting Force Control



Cutting Speed

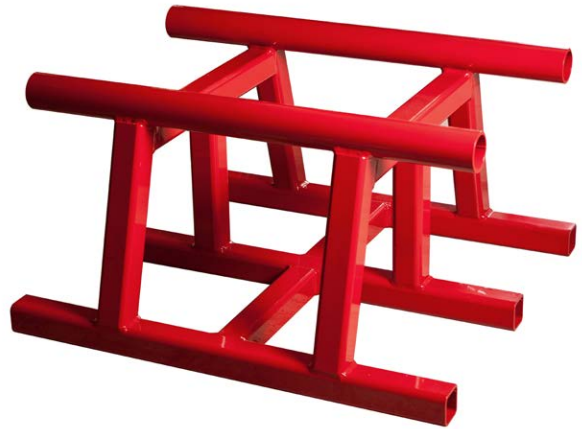

Bundle Support Table (optional)



Heavy Duty Gearbox

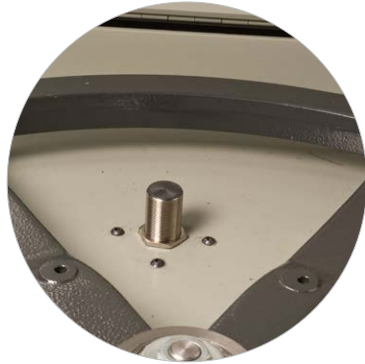

Safety Shutoff Sensor

Automatic Cutting Force Control:

During larger sections of the vessel, the saw feed automatically pauses while maintaining consistent cutting force to increase productivity without sacrificing blade life.

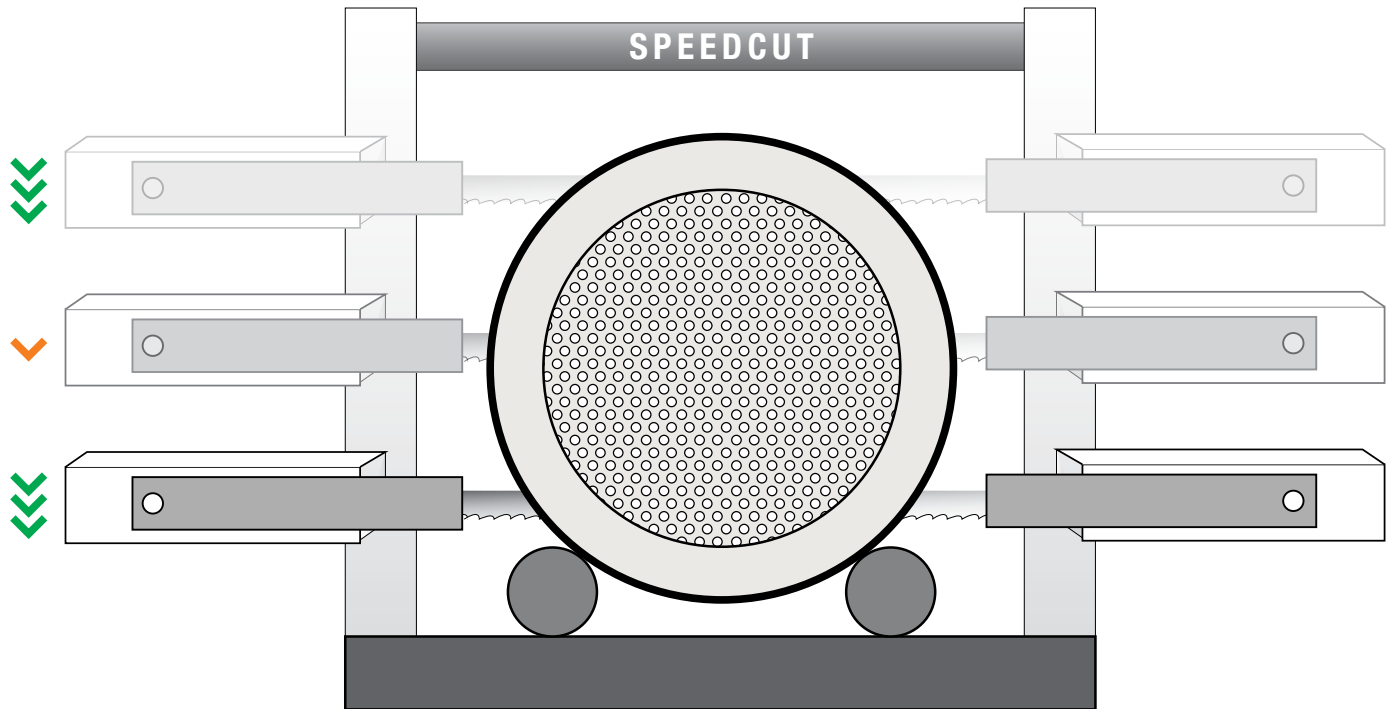

SPEEDCUT

Tube Bundle Cutter

TUBE BUNDLE CUTTER

| | SpeedCut 78 | SpeedCut 98 |
|--------------------|--|---------------|
| Power | | |
| Blade Motor | 7.5 HP (5.6kW) | 10 HP (7.4kW) |
| Hydraulic Motor | 1 HP (.75kW) | |
| Hydraulic Capacity | 10 gal | |
| Power Requirement | 3 Phase - 50/60 Hz (Select from 208V - 600V) | |

| Cutting | | |
|--------------------------------|--|---|
| Cutting Capacity (round) | 78.5" (2,000mm) | 98.5" (2,500mm) |
| Cutting Capacity (rectangular) | 78.5" (2,000mm) height | 98.5" (2,500mm) height |
| | 85" (2,160mm) width | 98.5" (2,500mm) width |
| Minimum Cutting Diameter | 25.5" (647.7 mm) | 25.5" (647.7 mm) |
| Cutting Depth/Throat | 33.75" (857mm) | |
| Blade Speed (typical speed) | 50 - 275 FPM Infinitely Variable (15 - 84 mpm) | |
| Blade Size | 1.5" x .05" x 375" (38mm x 1mm x 9,779mm) | 1.5" x .05" x 402" (38mm x 1mm x 10,211mm) |
| Typical Bundle Cutting Time | 20 - 60 minutes | |

| Dimensions & Weight | | |
|---------------------------------|-----------------------|-----------------------|
| Working Area | 168" (4,267mm) height | 213" (5,410mm) height |
| | 178" (4,521mm) width | 192" (4,877mm) width |
| | 87" (2,210mm) depth | |
| Minimum Height | 117" (2,972mm) | 134" (3,404mm) |
| Bandwheels | 36" (914mm) cast iron | |
| Weight | 7,500 lbs. (3,402Kg) | 8,500 lbs. (3,856Kg) |
| Shipping Dimensions (Crated) | 130" (3,302mm) height | 143" (3,632mm) height |
| | 186" (4,724mm) width | 199" (5,054mm) width |
| | 100" (2,540mm) depth | |
| Shipping Weight* (Crated) | 9,500 lbs. (4,309Kg) | 10,500 lbs. (4,763Kg) |
| Bundle Support Table (uncrated) | 20" (508mm) height | |
| | 33" (838mm) width | |
| | 36" (914mm) depth | |
| Support Table Weight (uncrated) | 225lbs (102Kg) | |

*Crate weight is based on an average unit. The final weight may vary.

| Spares & Accessories | | |
|---------------------------------|---------------|---------|
| Bi-Metal Bandsaw Blades* | SCT78B1 | SCT98B1 |
| | SCT78B2 | SCT98B2 |
| | SCT78B3 | SCT98B3 |
| MQL Lubricant (1 gal) | SCT100318-028 | |
| Bundle Support Table | SCTBT | |
| Clamp System | SCTMC | |
| Recommended Spares Kit | SCT155291 | |

*For help with blade selection, use the Blade Selection Tool at www.elliott-tool.com/speedcut or contact Elliott for assistance.



SpeedCut 78
shown with Clamp System (optional)



HYDRAULIC PUMPS

HYDRAULIC PUMPS



Elliott's hydraulic pumps are used to power the Collet Style Tube Puller, Cyclgrip Semi-Continuous Puller, Tube Tuggers, and Stub Tugger. The hydraulic pumps' compact design is ideal for use in confined work areas. Other key features include an integral gauge, protective roll cage, and hydraulic quick disconnect.

Features & Benefits:

- Hydraulic Pump Run & Pressure On Demand - pump only runs when pendant switch is activated to reduce the size of the oil reservoir and increase efficiency.

Spares & Accessories:

- 17-9637 Standard Oil
- M5773SO Synthetic Oil (Used in hot environments)
- 17-10804 Brush Assembly

| Part Number | Pump Type | HP | Maximum Operating Pressure (psi) | Power Requirement | Weight | | Repair Kit | Elliott Puller Used | |
|--------------|---------------|------|----------------------------------|-------------------|--------|------|------------|------------------------------------|---|
| | | | | | Lbs. | Kg. | | | |
| M5783-00 | 110V Electric | 1.13 | 5,000 | 2&5 Amps @110V | 80 | 36.3 | 17-300839 | • Collet Tube Puller • Cyclgrip | |
| M5783-00-220 | 220V Electric | | | 15 Amps @220V | | | | | |
| M5773-00 | 110V Electric | | 10,000 | 25 Amps @110V | 88 | 39.9 | | 17-300332 | • Super Collet Tube Puller • Tube Tugger • Super Tube Tugger • Stub Tugger |
| M5776-00 | 220V Electric | | | 15 Amps @220V | | | | | |
| M5775-00 | Pneumatic | 3 | 50 cfm @80 psi | 91 | 41.3 | | | | |
| 80-36102D3 | Manual | NA | 10,000 | NA | 28 | 12.7 | 17-300508 | | |



COLLET TUBE PULLER

Tube Size

- 0.625" to 1.000" OD
- (15.9 to 25.4mm) OD



Elliott's Model B10552-00 Collet Tube Puller was designed for fast and efficient tube removal in condensers, and chillers.

With its 6 Ton pulling capacity, the Collet Tube Puller automatically grips, pulls, and releases the tube in a matter of seconds. The puller's compact design allows access to confined work areas. Additionally, the 360° Positioning Handle enables access to those hard-to-reach tubes that are near channel plates and water box conditions.

The Collet Tube Puller can quickly and successfully pull over 100 tube stubs in less than an hour! To allow for even faster tube pulling, use Elliott's Cyclgrip Semi-Continuous Tube Puller – the perfect partner for the Collet Tube Puller.

Features & Benefits:

- Quick stroke cylinder - increases productivity.
- Lightweight pulling ram - reduces operator fatigue.
- Wide gripping range - less tooling expense.
- 360 degree positioning handle - more access to tubes.

Spares & Accessories:

- M5783-00 110V Electric Hydraulic Pump:
You must have this pump in order to properly operate the Collet Style Tube Puller.
- M5783-00-220 220V Electric Hydraulic Pump:
You must either purchase or already have this pump on order to properly operate the Collet Style Tube Puller.
- Tool Kit: Consists of a Collet Set, Draw Bar, and Nose Piece.
- Collet Set*: Consists of a Collet, Flat Spring, and an O-ring.
- Draw Bar*
- Nose Piece*
- TCB20-33 Counter Balance
- 17-300576 Seal Kit

* Required to operate the Collet Puller

Specifications:

- Pulling capacity: 6 Ton
- Stroke: 3" (76.0mm) Pulling Stroke 2.25" (57.2mm)
- Weight: 25 Lbs. (11 Kg)
- Overall Length:
 - Retracted: 20.5" (520.7mm)
 - Extended: 21.75" (552.6mm)

B10552-00 Collet Style Tube Puller kit includes:

- B10552 Collet Tube Puller Assembly
- B10552D5-750 Collet Retainer for 5/8" (15.9mm) and 3/4" (19.1mm) tube ODs
- B10552D7-750 Pull Rod for 5/8" (15.9mm) and 3/4" (19.1mm) tube ODs
- B10552D5-1000 Collet Retainer for 7/8" (22.2mm) and 1" (25.4mm) tube ODs
- B10552D7-1000 Pull Rod for 7/8" (22.2mm) and 1" (25.4mm) tube ODs
- B10552D20 15 ft. (4.6M) Hydraulic Hose Assembly

| Tube OD | BWG* | Collet Puller | Tool Kit** | Collet Set | Draw Bar | Nose Piece |
|------------------|-------|---------------|----------------|---------------|---------------|---------------|
| 5/8" (15.9mm) | 18-20 | B10552-00 | B10552-625KIT | B10552D3-625 | B10552D2-625 | B10552D4-625 |
| 3/4" (19.1mm) | 16-20 | | B10552-750KIT | B10552D3-750 | B10552D2-750 | B10552D4-750 |
| 7/8" (22.2mm) | 16-20 | | B10552-875KIT | B10552D3-875 | B10552D2-1000 | B10552D4-875 |
| 1" (25.4mm) | 16-20 | | B10552-1000KIT | B10552D3-1000 | B10552D2-1000 | B10552D4-1000 |

* NOTE: Softer metals could go up to 22 gauge.

**Includes a Collet Set, Draw Bar, and Nose Piece.



SUPER COLLET TUBE PULLER

SUPER COLLET TUBE PULLER

Hole Size

- 0.50" to 2.50" OD
- (12.70 to 63.5mm) OD



POWERFUL GRIP FOR FAST TUBE PULLING.

With the same gripping power of Elliott's proven spears.

Elliott's super collet tube puller is designed to quickly pull tube stubs from tube sheets without damaging the tube sheet hole. The collet teeth have been designed using the same principles as Elliott's proven TT Spear. Offering the gripping power of a spear with the speed and convenience of a collet.

The super collet tube puller is powered by an electric or pneumatic hydraulic pump to provide up to 25 tons of pulling capacity. Available in 2 pulling heads to cover tube sizes from 1/2" up to 2-1/2".

| Puller Specifications | | | | |
|-----------------------|---------------------|--------|----------------|--------|
| Puller | Requirements | Stroke | Pulling Stroke | Weight |
| CPS15 | 15 Ton @ 10,000 PSI | 6.75" | 6.00" | 40 lbs |
| CPS25 | 25 Ton @ 10,000 PSI | | | 55 lbs |



Collets Offer Powerful Spear-Like Gripping Power



Vertical Or Horizontal Eye Bolts



Built-in Pump Control

Quickly Remove Tube Stubs

Robust & Powerful For Fast Tube Removal

Just insert the collet and quickly remove the tube stub.

Save Hours Of Machine Time

Pull stubs easily without the need to machine the tube ID for knockout.

Protects The Tube Sheet

Don't risk damaging tube sheets from drilling and/or tube knockout tools.

No spears!

One step operation lowers cost and saves time by avoiding inserting, removing, and breaking spears as you pull.

Safe & Simple For Operators

One-Man Operation

Convenient pump control is built into the handles and works seamlessly with Elliott's electric hydraulic pumps.

Easy To Use

Eye-bolts for easily connecting to a counterbalance in both horizontal or vertical pulling applications.

Improves Safety

The deflector shield protects the opposite end of tube sheet during horizontal pulling applications.

Package Includes:

- Pulling Head
- Two Hydraulic Hoses
- Deflector Shield: CP300

Spares & Accessories:

- Collet
- Draw Bar
- Tie Rod
- Nose Piece
- Counterbalance: TCB48-66
- Hydraulic Pump Retrofit Kit: M5773RFK (Allows existing M5773-00 & M5776-00 pumps to be used with the Super Collet Puller)

Pumps:

- 110V: M5773-00 (See page 202)
- 220V: M5776-00 (See page 202)
- Pneumatic: M5775-00* (See page 202)

*Does not work with side handle buttons.



SUPER COLLET TUBE PULLER

Spares & Accessories

SUPER COLLET TUBE PULLER

| Tube OD | BWG | Expansion Range | | | | Collet | Draw Bar | Tie Rod | Nose Piece |
|----------------------|---------|-----------------|-------|-------|-------|------------|----------|---------|------------|
| | | Inch | | mm | | | | | |
| | | Min | Max | Min | Max | | | | |
| 1/2" (12.7 mm) | 14 - 15 | 0.326 | 0.418 | 8.28 | 10.62 | CPC500-14 | CPD500 | CPT500 | CPN500 |
| | 16 - 18 | 0.362 | 0.454 | 9.19 | 11.53 | CPC500-16 | | | |
| | 19 - 22 | 0.408 | 0.500 | 10.36 | 12.7 | CPC500-19 | | | |
| 5/8" (15.9 mm) | 14 - 15 | 0.451 | 0.543 | 11.46 | 13.80 | CPC625-14 | CPD625 | CPT625 | CPN625 |
| | 16 - 18 | 0.487 | 0.579 | 12.37 | 14.71 | CPC625-16 | | | |
| | 19 - 22 | 0.533 | 0.625 | 13.54 | 15.88 | CPC625-19 | | | |
| 3/4" (19.05 mm) | 12 - 13 | 0.530 | 0.622 | 13.46 | 15.80 | CPC750-12 | CPD750 | CPT750 | CPN750 |
| | 14 - 15 | 0.576 | 0.668 | 14.63 | 16.97 | CPC750-14 | | | |
| | 16 - 18 | 0.612 | 0.704 | 15.54 | 17.88 | CPC750-16 | | | |
| 7/8" (22.2 mm) | 12 - 13 | 0.655 | 0.747 | 16.64 | 18.97 | CPC875-12 | CPD875 | CPT875 | CPN875 |
| | 14 - 15 | 0.701 | 0.793 | 17.81 | 20.14 | CPC875-14 | | | |
| | 16 - 18 | 0.737 | 0.829 | 18.72 | 21.06 | CPC875-16 | | | |
| 1" (25.4 mm) | 10 - 11 | 0.730 | 0.822 | 18.54 | 20.88 | CPC1000-10 | CPD1000 | CPT1000 | CPN1000 |
| | 12 - 13 | 0.780 | 0.872 | 19.81 | 22.15 | CPC1000-12 | | | |
| | 14 - 15 | 0.826 | 0.918 | 20.98 | 23.32 | CPC1000-14 | | | |
| 1-1/8" (28.58 mm) | 16 - 18 | 0.862 | 0.954 | 21.90 | 24.23 | CPC1000-16 | CPD1000 | CPT1000 | CPN1000 |
| | 19 - 22 | 0.908 | 1.000 | 23.06 | 25.40 | CPC1000-19 | | | |
| | 10 - 11 | 0.855 | 0.947 | 21.72 | 24.05 | CPC1125-10 | | | |
| 1-1/8" (28.58 mm) | 12 - 13 | 0.905 | 0.997 | 22.99 | 25.32 | CPC1125-12 | CPD1125 | CPT1125 | CPN1125 |
| | 14 - 15 | 0.951 | 1.043 | 24.16 | 26.50 | CPC1125-14 | | | |
| | 16 - 18 | 0.987 | 1.079 | 25.07 | 27.41 | CPC1125-16 | | | |
| 1-1/4" (31.8 mm) | 19 - 22 | 1.033 | 1.125 | 26.24 | 28.58 | CPC1125-19 | CPD1125 | CPT1125 | CPN1125 |
| | 10 - 11 | 0.980 | 1.072 | 24.89 | 27.23 | CPC1250-10 | | | |
| | 12 - 13 | 1.030 | 1.122 | 26.16 | 28.50 | CPC1250-12 | | | |
| 1-1/4" (31.8 mm) | 14 - 15 | 1.076 | 1.168 | 27.33 | 29.67 | CPC1250-14 | CPD1250 | CPT1250 | CPN1250 |
| | 16 - 18 | 1.112 | 1.204 | 28.25 | 30.58 | CPC1250-16 | | | |
| | 19 - 22 | 1.158 | 1.250 | 29.41 | 31.75 | CPC1250-19 | | | |
| 1-3/8" (34.9 mm) | 10 - 11 | 1.105 | 1.197 | 28.07 | 30.40 | CPC1375-10 | CPD1375 | CPT1375 | CPN1375 |
| | 12 - 13 | 1.155 | 1.247 | 29.34 | 31.67 | CPC1375-12 | | | |
| | 14 - 15 | 1.201 | 1.293 | 30.51 | 32.84 | CPC1375-14 | | | |
| 1-1/2" (38.1 mm) | 16 - 18 | 1.237 | 1.329 | 31.42 | 33.76 | CPC1375-16 | CPD1375 | CPT1375 | CPN1375 |
| | 19 - 22 | 1.283 | 1.375 | 32.59 | 34.93 | CPC1375-19 | | | |
| | 10 - 11 | 1.230 | 1.322 | 31.24 | 33.58 | CPC1500-10 | | | |
| 1-1/2" (38.1 mm) | 12 - 13 | 1.280 | 1.372 | 32.51 | 34.85 | CPC1500-12 | CPD1500 | CPT1500 | CPN1500 |
| | 14 - 15 | 1.326 | 1.418 | 33.68 | 36.02 | CPC1500-14 | | | |
| | 16 - 18 | 1.362 | 1.454 | 34.60 | 36.93 | CPC1500-16 | | | |
| 2" (50.8mm)* | 19 - 22 | 1.408 | 1.500 | 35.76 | 38.10 | CPC1500-19 | CPD1500 | CPT1500 | CPN1500 |
| | 10-11 | 1.730 | 1.824 | 43.94 | 46.33 | CPC2000-10 | | | |
| | 12-13 | 1.780 | 1.871 | 45.21 | 47.52 | CPC2000-12 | | | |
| 2" (50.8mm)* | 14-15 | 1.826 | 1.917 | 46.38 | 48.69 | CPC2000-14 | CPD2000 | CPT2000 | CPN2000 |
| | 16-18 | 1.862 | 1.954 | 47.29 | 49.63 | CPC2000-16 | | | |
| | 19-22 | 1.908 | 1.986 | 48.46 | 50.44 | CPC2000-19 | | | |
| 2-1/2" (63.5mm)* | 10-11 | 2.230 | 2.324 | 56.64 | 59.03 | CPC2500-10 | CPD2500 | CPT2500 | CPN2500 |
| | 12-13 | 2.280 | 2.371 | 57.91 | 60.22 | CPC2500-12 | | | |
| | 14-15 | 2.326 | 2.417 | 59.08 | 61.39 | CPC2500-14 | | | |
| 2-1/2" (63.5mm)* | 16-18 | 2.362 | 2.454 | 59.99 | 62.33 | CPC2500-16 | CPD2500 | CPT2500 | CPN2500 |
| | 19-22 | 2.408 | 2.486 | 61.16 | 63.14 | CPC2500-19 | | | |

* Requires CP2000P pulling head package.





GLOBAL CHANNEL SUPPORT YOU CAN RELY ON

Local expertise. Consistent standards. Worldwide reach.

At Elliott Tool Technologies, our channel partners are a **critical part** of how we support customers around the world. Through a carefully developed global channel network, we work closely with trusted partners to deliver Elliott tools, knowledge, and service; wherever the job is.

Global Coverage

Access to Elliott solutions through established partners worldwide.

Local Support

Regional presence backed by Elliott's engineering, application, and manufacturing expertise.

Consistent Standards

Alignment on product knowledge, application best practices, and customer expectations.

Collaborative Approach

Ongoing communication and support to help partners succeed in their markets.



**Contact us today to learn more
about our channel support.**

Tube Size

- 0.500" to 1.000" OD
- (12.7 to 25.4mm) OD

Elliott's M5630-00 Cyclgrip Semi-Continuous Tube Puller is an engineered product that continuously pulls chiller tubes after the tubes have been pulled free from the tube sheet, making it the ideal companion for the Collet Style Tube Puller.

The Cyclgrip's unique design allows it to adjust to tube sizes without any additional tooling or tool adjustments. The puller's slim profile allows side tube mounting adjacent to water box and channel plates.

Additionally, the Cyclgrip easily pulls tubes that have been expanded into baffle or support plates, eliminating the use of tiresome slam hammers and accelerating the tube removal.



Features & Benefits:

- Lightweight & compact design - easy to move in tight areas.
- 10 ft (3.3M) per minute pulling action - greater productivity.
- Simple design - easy to maintain.
- No extra tooling required - lower tooling expense.

Specifications:

- Pulled tube projection required: 3" (76.2mm)
- Face plate dimensions: 3.75" (95.3mm) wide x 2.94" (74.7mm) high
- Stroke length: 5" (127.0mm)
- Pulling rate: 10'/min. (3.3M/min.)
- Height: 10.75" (273.0mm)
- Length: 8.44" (214.4mm)
- Width: 4.13" (104.9mm)
- Weight: 16 Lbs. (7.3 Kg)

M5630-00 Cyclgrip Semi-Continuous Tube Puller package includes:

- Extractor Unit
- 15 ft (4.6M) Hydraulic Hose
- Control Cable
- Carrying Case

Spares & Accessories:

- *M5783-00 110V Electric Hydraulic Pump: You must either purchase or already have this pump on order to properly operate the Cyclgrip.
- *M5783-00-220 220V Electric Hydraulic Pump: You must either purchase or already have this pump on order to properly operate the Cyclgrip.
- TCB20-33 Counter Balance.

* Required to operate the Cyclgrip.



TUBE TUGGER

Semi-Continuous Hydraulic Tube Pulling System

Tube Size

- 0.625" to 1.250" OD
- (15.9 to 31.8mm) OD



Elliott's Tube Tugger is a powerful semi-continuous hydraulic tube pulling system for removing tubes from heat exchangers, chillers, and other heat transfer vessels.

With its 30 Ton pulling capacity, the Elliott Tube Tugger breaks expanded tube sheet joint bonds. The tugger then takes over and continuously pulls the tube when any obstructions are met. In many applications, tubes can be pulled from both tube sheets from one end of the heat exchanger.

The Tube Tugger's compact length of 15" (381.0mm) allows it to be used in confined space areas. For close clearance conditions or for extended reach, Nose Piece Extensions are available. Contact Customer Service for details.

Features & Benefits:

- Portable ram & pump - easy to move in tight areas.
- High production pulling action - lower labor cost.
- Best value - more productivity & less capital investment.

Tube Tugger kit includes:

- Tube Pulling Hydraulic Cylinder
- Suspension Bracket Assembly with Side Handles
- Collet Holder Assembly
- (2) 15 ft. (4.6M) Hydraulic Hose
- Release Fork
- Nose Piece Adapter
- Set of Spanner Wrenches

Spares & Accessories:

- Hydraulic Pump: M5773-00 110V Electric Pump, M5776-00 220V Electric Pump, M5775-00 Pneumatic Pump. You must either purchase or already have one of these pumps in order to properly operate the Tube Tugger.
- TCB48-66 Counter Balance
- 17-300077 Seal Repair Kit
- Spears *See page 214* *
- Collet Set *See table on page 215.* *
- Nose Piece *See table on page 215.* *

* Required to operate the Tube Tugger

| Puller Specifications | | | | | | |
|-----------------------|--------------------|---------------------|---------------------|----------------------|----------------------|----------------------|
| Puller | Capacity | Stroke | Diameter | Lengths | | |
| | | | | Collapsed | Extended | Across Handles |
| 80-40125 | 30 Ton (27.2Mt) | 3.000" (76.2mm) | 6.500" (165.1mm) | 12.940" (329.0mm) | 15.940" (405.0mm) | 18.250" (464.0mm) |
| 80-40125-6 | | 6.000" (152.4mm) | | 18.000" (457.0mm) | 22.000" (559.0mm) | |



Optional Counterbalance



SUPER TUBE TUGGER

Semi-Continuous Hydraulic Tube Pulling System

Tube Size

- 1.500" to 2.000" OD
- (38.1 to 50.8mm) OD



Elliott's Super Tube Tugger is a powerful semi-continuous hydraulic tube pulling system for removing tubes from surface condensers and certain boiler applications.

With its 60 Ton pulling capacity, the Elliott Super Tube Tugger breaks expanded tube sheet joint bonds. The tugger then takes over and continuously pulls the tube when any obstructions are met.

The Super Tube Tugger's compact length of 18" (457.0mm) allows it to be used in confined space areas.

Features & Benefits:

- Portable ram & pump - easy to maneuver in tight areas.
- High production pulling action - lower labor cost.
- High tonnage - makes difficult job easy.

Specifications:

- Capacity: 60 Ton (54.4Mt).
- Stroke: 4.000" (101.0mm).
- Tugger Diameter: 8.500" (215.9mm).
- Lengths:
 - Collapsed: 18.000" (457.0mm).
 - Extended: 22.000" (559.0mm).
- Length Across Handles: 18.250" (464.0mm).
- Weight: 62 Lbs. (28.0Kg).

80-40200 Super Tube Tugger kit includes:

- Tube Pulling Hydraulic Cylinder
- Suspension Bracket Assembly with Side Handles
- Collet Holder Assembly
- (2) 15 ft. (4.6M) Hydraulic Hose
- Release Fork
- Nose Piece Adapter
- Set of Spanner Wrenches

Spares & Accessories:

- Hydraulic Pump: M5773-00 110V Electric Pump, M5776-00 220V Electric Pump, M5775-00 Pneumatic Pump. You must either purchase or already have one of these pumps in order to properly operate the Super Tube Tugger.
- TCB66-88 Counter Balance
- Spears *See page 215.* *
- Collet Set *See table on page 215.* *
- Nose Piece *See table on page 215.* *

* Required to operate the Super Tube Tugger



Optional Counterbalance



CUTTING DOWN TURNAROUND TIME

THE BENEFITS OF A TUBE BUNDLE CUTTER



FOR FABRICATION SHOPS with large, recurring workloads, the time needed to retube a heat exchanger is a constant drag on productivity. Manual methods of tube removal are time-consuming and labor-intensive, often stretching projects out over multiple weeks. One way to reduce job

time is by using a tube bundle cutter or bundle saw. This can dramatically speed up the retubing process, offering significant benefits in terms of time, safety, and ultimately, cost savings.

WHY USE A TUBE BUNDLE CUTTER?

The biggest benefit of using a bundle saw is the drastic reduction in project duration. A large retubing job performed by hand can typically take two to three weeks to complete. This span covers the entire process: pulling the bundle, manually cutting the tubes, pulling tube sections from the baffles, and finally, removing stubs from the tube sheet.

A dedicated tube bundle saw can reduce this two-to-three-week project down to just a few days, with the actual cutting of the tubes often taking only a single day.

This significant reduction in downtime translates directly into cost savings. While a bundle saw represents a considerable capital investment, the return on investment (ROI) is realized quickly through reduced labor hours and increased facility throughput. The key metric to focus on is the time it takes to prepare and clear the tube sheet. If a shop is performing multiple retubing jobs a week, the speed and efficiency gained will easily justify the expense of the saw itself.

Beyond speed, bundle saws offer an inherent safety advantage by mechanizing a process that is traditionally filled with manual cutting and heavy lifting, reducing the potential for strain or injury to personnel.

THE PROCESS: USING THE TUBE BUNDLE CUTTER

Using a tube bundle cutter is a streamlined process that, when executed correctly, ensures a fast and clean separation of the tubes from the tube sheets.

Preparation and Setup

The process begins even before the bundle reaches the saw. The outside diameter (OD) of the vessel and tubes must be thoroughly cleaned to remove any large amounts of debris, scale, or leftover chemicals. This is a crucial step for facility safety and to prevent contamination.

Once clean, the bundle is transported to the saw and secured. The bundle is clamped and precisely leveled, ensuring full support across the entire length of the unit. Proper leveling is critical; if the unit is not level, the saw blade will face unnecessary resistance from pulling forces during the cut. This resistance can slow the cutting process and potentially lead to premature blade breakage.

The Cut

With the bundle secured, the saw is used to cut the tubes behind the tube sheet on the first end. Once the tubes are cut, the loose ends are often tied together to prevent them from pulling apart or shifting. The entire unit is then flipped, and the tubes are cut from behind the tube sheet on the other end, completely separating the tubes from both sheets.

Stub Removal and Reassembly

With the bulk of the tubes removed, the next step is clearing the tube stubs from the sheets. One of the fastest and safest methods is utilizing a collet-style puller. This tool grips the internal diameter of the stub and pulls it out, preventing any potential tube sheet damage and allowing for quicker removal. A knockout tool can also be used as an alternative or supplementary method to dislodge any remaining stubs.

Once the tube sheets are clear, they can be cleaned up, measured, and have the tube holes resurfaced and prepared for new tubes. Some customers will also request that the remaining tube sections be pulled from the baffles so that the baffles can be reused, depending on their condition, material, and the cost to replace them.

Overall, utilizing a tube bundle cutter can significantly reduce job duration, increase operator safety, and drive shop throughput, providing a true competitive advantage.



Elliott's SpeedCut Bundle Cutter

TAPPING SPEARS

Tube Size

- 0.625" to 1.000" OD
- (15.9 to 25.4mm) OD



Elliott's TT Series Tapping Spears are designed to withstand the toughest tube removal applications, for longer tool life on exotic materials.

Used in combination with Elliott's TT pulling spears, tapping spears are manufactured to meet a higher material hardness, allowing them to hold up longer when used on exotic materials. Simply thread the tapping spear into the tube end to create a tooth pattern in the tube ID. Once it's been driven in, remove the tapping spear and insert a standard pulling spear and remove the tube as normal.

Features & Benefits:

- Save on tooling costs by prolonging the life of pulling spears.
- Harder material allows for a better grip on exotic tube materials.

Spares & Accessories:

- P8788 Spear Lubricant: Highly recommended for use on spear threads to greatly increase spear life.



TAPPING SPEARS

TAPPING SPEARS

| Tube OD | BWG | Spear | Minimum Spear *Diameter | | Maximum Spear *Diameter | | Male Sq. Size |
|------------------|-------|------------|-------------------------|------|-------------------------|------|---------------|
| | | | Inch | mm | Inch | mm | |
| 5/8" (15.9mm) | 7 | TT625-7T | 0.245 | 6.2 | 0.385 | 9.8 | 1/2" |
| | 8-9 | TT625-8T | 0.280 | 7.1 | 0.432 | 11.0 | |
| | 10-12 | TT625-10T | 0.342 | 8.7 | 0.482 | 12.2 | |
| | 13-15 | TT625-13T | 0.425 | 10.8 | 0.545 | 13.8 | |
| | 16-18 | TT625-16T | 0.485 | 12.3 | 0.589 | 15.0 | |
| 3/4" (19.1mm) | 7 | TT750-7T | 0.370 | 9.4 | 0.528 | 13.4 | 5/8" |
| | 8-9 | TT750-8T | 0.405 | 10.3 | 0.576 | 14.6 | |
| | 10-12 | TT750-10T | 0.467 | 11.9 | 0.625 | 15.9 | |
| | 13-15 | TT750-13T | 0.550 | 14.0 | 0.685 | 17.4 | |
| | 16-18 | TT750-16T | 0.610 | 15.5 | 0.727 | 18.5 | |
| 7/8" (22.2mm) | 7 | TT875-7T | 0.495 | 12.6 | 0.653 | 16.6 | 5/8" |
| | 8-9 | TT875-8T | 0.530 | 13.5 | 0.701 | 17.8 | |
| | 10-12 | TT875-10T | 0.592 | 15.0 | 0.750 | 19.1 | |
| | 13-15 | TT875-13T | 0.675 | 17.1 | 0.810 | 20.6 | |
| | 16-18 | TT875-16T | 0.735 | 18.7 | 0.852 | 21.6 | |
| 1" (25.4mm) | 7 | TT1000-7T | 0.620 | 15.7 | 0.778 | 19.8 | 3/4" |
| | 8-9 | TT1000-8T | 0.655 | 16.6 | 0.826 | 21.0 | |
| | 10-12 | TT1000-10T | 0.717 | 18.2 | 0.875 | 22.2 | |
| | 13-15 | TT1000-13T | 0.800 | 20.3 | 0.935 | 23.7 | |
| | 16-18 | TT1000-16T | 0.860 | 21.8 | 0.977 | 24.8 | |
| 1-1/4" (31.8mm) | 7 | TT1250-7T | 0.870 | 22.1 | 1.028 | 26.1 | 3/4" |
| | 8-9 | TT1250-8T | 0.905 | 23.0 | 1.076 | 27.3 | |
| | 10-12 | TT1250-10T | 0.967 | 24.6 | 1.125 | 28.6 | |
| | 13-15 | TT1250-13T | 1.050 | 26.7 | 1.185 | 30.1 | |
| | 16-18 | TT1250-16T | 1.110 | 28.2 | 1.227 | 31.2 | |
| 1-1/2" (38.1mm) | 7 | TT1500-7T | 1.120 | 28.4 | 1.278 | 32.5 | 1" |
| | 8-9 | TT1500-8T | 1.155 | 29.3 | 1.326 | 33.7 | |
| | 10-12 | TT1500-10T | 1.217 | 30.9 | 1.375 | 34.9 | |
| | 13-15 | TT1500-13T | 1.300 | 33.0 | 1.435 | 36.4 | |
| | 16-18 | TT1500-16T | 1.360 | 34.5 | 1.477 | 37.5 | |
| 1-3/4" (44.5mm) | 7 | TT1750-7T | 1.370 | 34.8 | 1.528 | 38.8 | 1" |
| | 8-9 | TT1750-8T | 1.405 | 35.7 | 1.576 | 40.0 | |
| | 10-12 | TT1750-10T | 1.467 | 37.3 | 1.625 | 41.3 | |
| | 13-15 | TT1750-13T | 1.550 | 39.4 | 1.685 | 42.8 | |
| | 16-18 | TT1750-16T | 1.610 | 40.9 | 1.727 | 43.9 | |
| 2" (50.8mm) | 7 | TT2000-7T | 1.620 | 41.1 | 1.778 | 45.2 | 1" |
| | 8-9 | TT2000-8T | 1.655 | 42.0 | 1.826 | 46.4 | |
| | 10-12 | TT2000-10T | 1.717 | 43.6 | 1.875 | 47.6 | |
| | 13-15 | TT2000-13T | 1.800 | 45.7 | 1.935 | 49.1 | |
| | 16-18 | TT2000-16T | 1.860 | 47.2 | 1.977 | 50.2 | |
| | 19-24 | TT2000-19T | 1.906 | 48.4 | 2.000 | 50.8 | |



TT TUBE SPEARS

Tube Size

- 0.625" to 2.000" OD
- (15.9 to 50.8mm) OD



Elliott's TT Spears are used with the Elliott Tube Tugger or Super Tube Tugger to successfully pull tubes in chillers, heat exchangers, condensers, fin fan coolers, and boilers.

Simply size the spear, apply spear lubricant on the pulling teeth, and then set the spear by employing a hand ratchet or impact wrench. To relieve pressure, back the spear off and then employ the Tube Tugger or Super Tube Tugger to successfully remove the tube.

Features & Benefits:

- Reduce tooling costs with an innovative design that withstands significantly more force than other spears.
- Engineered design lowers the chance that the gripping end of the spear will break off in the tube, saving time, money and hassle.

Spares & Accessories:

- P8788 Spear Lubricant: Highly recommended for use on spear threads to greatly increase spear life.

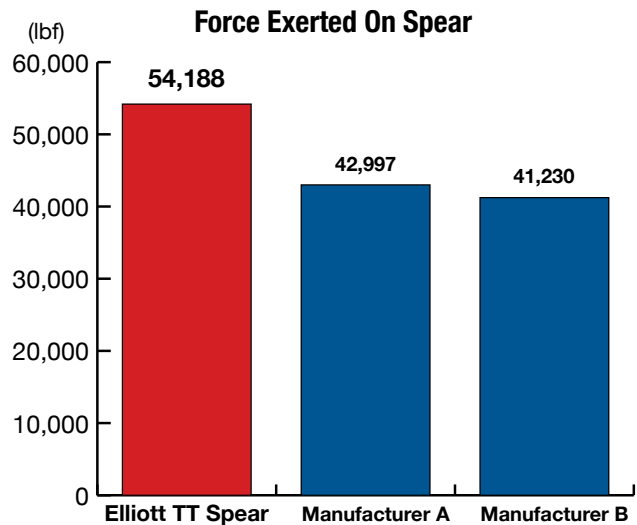

TUBE TUGGER & SUPER TUBE TUGGER

Spares & Accessories

| Tube OD | BWG | Spear | | Minimum Spear *Diameter | | Maximum Spear *Diameter | | Male Sq. Size | Nose Piece | *Collet Set with O-Ring |
|--------------------|-------|--------------------|--------------------|-------------------------|------|-------------------------|------|---------------|--------------|-------------------------|
| | | 29" Overall Length | 48" Overall Length | Inch | mm | Inch | mm | | | |
| 5/8" (15.9mm) | 7 | TT625-7 | TT625-7-48 | 0.245 | 6.2 | 0.385 | 9.8 | 1/2" | 80-40125N062 | 80-40125C062 |
| | 8-9 | TT625-8 | TT625-8-48 | 0.280 | 7.1 | 0.432 | 11.0 | | | |
| | 10-12 | TT625-10 | - | 0.342 | 8.7 | 0.482 | 12.2 | | | |
| | 13-15 | TT625-13 | - | 0.425 | 10.8 | 0.545 | 13.8 | | | |
| | 16-18 | TT625-16 | - | 0.485 | 12.3 | 0.589 | 15.0 | | | |
| | 19-24 | TT625-19 | - | 0.531 | 13.5 | 0.615 | 15.6 | | | |
| 3/4" (19.1mm) | 7 | TT750-7 | TT750-7-48 | 0.370 | 9.4 | 0.528 | 13.4 | 5/8" | 80-40125N075 | 80-40125C075 |
| | 8-9 | TT750-8 | TT750-8-48 | 0.405 | 10.3 | 0.576 | 14.6 | | | |
| | 10-12 | TT750-10 | TT750-10-48 | 0.467 | 11.9 | 0.625 | 15.9 | | | |
| | 13-15 | TT750-13 | TT750-13-48 | 0.550 | 14.0 | 0.685 | 17.4 | | | |
| | 16-18 | TT750-16 | TT750-16-48 | 0.610 | 15.5 | 0.727 | 18.5 | | | |
| | 19-24 | TT750-19 | TT750-19-48 | 0.656 | 16.7 | 0.750 | 19.1 | | | |
| 7/8" (22.2mm) | 7 | TT875-7 | TT875-7-48 | 0.495 | 12.6 | 0.653 | 16.6 | 5/8" | 80-40125N087 | 80-40125C087 |
| | 8-9 | TT875-8 | TT875-8-48 | 0.530 | 13.5 | 0.701 | 17.8 | | | |
| | 10-12 | TT875-10 | TT875-10-48 | 0.592 | 15.0 | 0.750 | 19.1 | | | |
| | 13-15 | TT875-13 | TT875-13-48 | 0.675 | 17.1 | 0.810 | 20.6 | | | |
| | 16-18 | TT875-16 | TT875-16-48 | 0.735 | 18.7 | 0.852 | 21.6 | | | |
| | 19-24 | TT875-19 | TT875-19-48 | 0.781 | 19.8 | 0.875 | 22.2 | | | |
| 1" (25.4mm) | 7 | TT1000-7 | TT1000-7-48 | 0.620 | 15.7 | 0.778 | 19.8 | 3/4" | 80-40125N100 | 80-40125C100 |
| | 8-9 | TT1000-8 | TT1000-8-48 | 0.655 | 16.6 | 0.826 | 21.0 | | | |
| | 10-12 | TT1000-10 | TT1000-10-48 | 0.717 | 18.2 | 0.875 | 22.2 | | | |
| | 13-15 | TT1000-13 | TT1000-13-48 | 0.800 | 20.3 | 0.935 | 23.7 | | | |
| | 16-18 | TT1000-16 | TT1000-16-48 | 0.860 | 21.8 | 0.977 | 24.8 | | | |
| | 19-24 | TT1000-19 | TT1000-19-48 | 0.906 | 23.0 | 1.000 | 25.4 | | | |
| 1-1/4" (31.8mm) | 7 | TT1250-7 | TT1250-7-48 | 0.870 | 22.1 | 1.028 | 26.1 | 3/4" | 80-40125N125 | 80-40125C125 |
| | 8-9 | TT1250-8 | TT1250-8-48 | 0.905 | 23.0 | 1.076 | 27.3 | | | |
| | 10-12 | TT1250-10 | TT1250-10-48 | 0.967 | 24.6 | 1.125 | 28.6 | | | |
| | 13-15 | TT1250-13 | TT1250-13-48 | 1.050 | 26.7 | 1.185 | 30.1 | | | |
| | 16-18 | TT1250-16 | TT1250-16-48 | 1.110 | 28.2 | 1.227 | 31.2 | | | |
| | 19-24 | TT1250-19 | TT1250-19-48 | 1.156 | 29.4 | 1.250 | 31.8 | | | |
| 1-1/2" (38.1mm) | 7 | TT1500-7 | TT1500-7-48 | 1.120 | 28.4 | 1.278 | 32.5 | 1" | 80-40200N150 | 80-40200C150 |
| | 8-9 | TT1500-8 | TT1500-8-48 | 1.155 | 29.3 | 1.326 | 33.7 | | | |
| | 10-12 | TT1500-10 | TT1500-10-48 | 1.217 | 30.9 | 1.375 | 34.9 | | | |
| | 13-15 | TT1500-13 | TT1500-13-48 | 1.300 | 33.0 | 1.435 | 36.4 | | | |
| | 16-18 | TT1500-16 | TT1500-16-48 | 1.360 | 34.5 | 1.477 | 37.5 | | | |
| | 19-24 | TT1500-19 | TT1500-19-48 | 1.406 | 35.7 | 1.500 | 38.1 | | | |
| 1-3/4" (44.5mm) | 7 | TT1750-7 | TT1750-7-48 | 1.370 | 34.8 | 1.528 | 38.8 | 1" | 80-40200N175 | 80-40200C175 |
| | 8-9 | TT1750-8 | TT1750-8-48 | 1.405 | 35.7 | 1.576 | 40.0 | | | |
| | 10-12 | TT1750-10 | TT1750-10-48 | 1.467 | 37.3 | 1.625 | 41.3 | | | |
| | 13-15 | TT1750-13 | TT1750-13-48 | 1.550 | 39.4 | 1.685 | 42.8 | | | |
| | 16-18 | TT1750-16 | TT1750-16-48 | 1.610 | 40.9 | 1.727 | 43.9 | | | |
| | 19-24 | TT1750-19 | TT1750-19-48 | 1.656 | 42.1 | 1.750 | 44.5 | | | |
| 2" (50.8mm) | 7 | TT2000-7 | TT2000-7-48 | 1.620 | 41.1 | 1.778 | 45.2 | 1" | 80-40200N200 | 80-40200C200 |
| | 8-9 | TT2000-8 | TT2000-8-48 | 1.655 | 42.0 | 1.826 | 46.4 | | | |
| | 10-12 | TT2000-10 | TT2000-10-48 | 1.717 | 43.6 | 1.875 | 47.6 | | | |
| | 13-15 | TT2000-13 | TT2000-13-48 | 1.800 | 45.7 | 1.935 | 49.1 | | | |
| | 16-18 | TT2000-16 | TT2000-16-48 | 1.860 | 47.2 | 1.977 | 50.2 | | | |
| | 19-24 | TT2000-19 | TT2000-19-48 | 1.906 | 48.4 | 2.000 | 50.8 | | | |

* O-Ring number P8309-225 is supplied with all Collet Sets.
Elliott highly recommends using P8788 Spear Lubricant with your spears to greatly increase spear life.



STUB TUGGER

Hydraulic Tube Pulling System

Tube Size

- 0.375" to 3.000" OD
- (9.5 to 76.2mm) OD



Elliott's Stub Tugger is a powerful hydraulic tube pulling system for removing tubes from heat exchangers and certain boiler applications.

The Elliott Stub Tugger is compatible with other competitive spear type tube pullers and its compact length of 22" (559.0mm) allows it to be used in confined space areas.

Features & Benefits:

- Extensive OD tube range - more versatility.
- Uses E-series spears - lower tooling cost.
- Hydraulic Cylinder Strike Plate - tool can be used as a slide hammer while still protecting the piston and seals, which increases convenience and efficiency.

Specifications:

- Capacity: 30 Ton (27.2Mt).
- Stroke: 6.000" (152.4mm).
- Tugger Diameter: 6.500" (165.1mm).
- Lengths:
 - Collapsed: 18.000" (457.0mm).
 - Extended: 22.000" (559.0mm).
- Length Across Handles: 18.250" (464.0mm).
- Weight: 46 Lbs. (20.9Kg).

80-40130 Stub Tugger kit includes:

- Tube Pulling Hydraulic Cylinder
- Suspension Bracket Assembly with Side Handles
- Nose Piece
- Nose Piece Adapter
- Load Cap
- Safety Shield
- (2) 15 ft. (4.6M) Hydraulic Hose

Spares & Accessories:

- Hydraulic Pump: M5773-00 110V Electric Pump, M5776-00 220V Electric Pump, M5775-00 Pneumatic Pump, or 80-36102D3 Hand Pump. You must either purchase or already have one of these pumps in order to properly operate the Stub Tugger.
- TCB48-66 Counter Balance
- 17-300822 Seal Repair Kit
- Spear *See table on page 220.*
- Spear Extension *See table on page 217.*
- Extension Chair (Required when using any extensions) *See table on page 217.*
- 80-3055-3-00 Spear Adapter *See table on page 217.*
- 80-3055-4 Horseshoe Lock *See table on page 217.*



Spear and accessory items for tube OD sizes 3/8" (9.5mm) thru 1" (25.4mm).



Spear (See table on page 220 for size)



Spear Adapter



Horseshoe Lock

Optional Spear Extensions Available

Recommended to allow the operator to work from the outside of the water box and channel plate applications.
If using an extension, both the extension chair & spear extension are required.



Extension Chair

+



Male X Male Spear Extension

Spear items for tube OD sizes 1-1/4" (31.8mm) thru 2-1/2" (63.5mm).

All parts below are required for use.



Spear (See table on page 220 for size)



Male X Male Spear Extension



Extension Chair



Spear Adapter



Horseshoe Lock

Spear Accessories:

| Spear Accessories | |
|-------------------------------|--------------|
| Accessories | Part Number |
| Spear Adapter | 80-3055-3-00 |
| Horseshoe Lock | 80-3055-4 |
| Male X Male Spear Extension | 80-3055-5 |
| Male X Female Spear Extension | 80-3055-10 |

| Extension Chair | |
|------------------------------------|-------------|
| Tube OD | Part Number |
| 3/8" - 1" (9.5 - 31.8mm) | 80-3055-7 |
| 1-1/2" - 1-3/4" (38.1 - 44.5mm) | 80-36307 |
| 2" (50.8mm) | 80-36308 |
| 2-1/4" - 2-1/2" (57.2 - 63.5mm) | 80-36309 |
| 3" (76.2mm) | 80-36311 |

An extension chair is required when using a spear extension.



MANUAL TUBE PULLER

Tube Size

- 3/8" to 1" OD
- (9.5 to 25.4mm) OD



Spear and nose pieces must be purchased separately.

Elliott's Model 904500 Manual Tube Puller is ideal for pulling a limited number of tubes in heat exchangers, chillers, fin fan coolers, and surface condensers.

The Manual Tube Puller incorporates a socket and thrust bearing to allow for use with an impact wrench. Elliott's manual tube puller is a great value because the puller works on tube ODs 3/8" to 1" (9.5 to 25.4mm), so all you need to purchase is a nose piece for each tube OD. E Series spears must be purchased separately.

The easy to use 904500 Manual Tube Puller allows you to pull tubes at a minimum tooling cost.

Features & Benefits:

- One puller accommodates tube OD sizes 3/8" to 1" (9.5 to 25.4mm) - only need to purchase nose piece.
- Uses standard spears - lower tool cost.
- Minimum investment - lower tool cost.
- Manual tool - no capital expense for pump & ram.
- Compact - easy to store.

Spares & Accessories:

- Spears *See table on page 220.**
- Nose Piece*

** Required to operate the Manual Tube Puller*

| Tube OD | Nose Piece |
|---------|------------|
| 3/8" | 904502-05 |
| 1/2" | 904502-04 |
| 5/8" | 904502-01 |
| 3/4" | 904502-02 |
| 7/8" | 904502-06 |
| 1" | 904502-03 |



E-SERIES HEX SPEARS

Tube Size

- 0.375" to 3.000" OD
- (9.5 to 76.2mm) OD

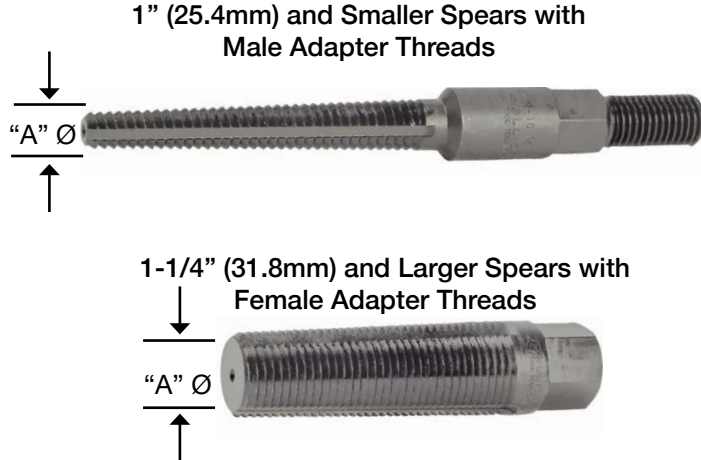

Elliott's E Series Hex Spears are used with the Elliott Stub Tugger or Manual Tube Puller to successfully pull tubes in chillers, heat exchangers, condensers, fin fan coolers, and boilers.

Simply size the spear, apply spear lubricant on the pulling teeth, and then set the spear by employing a hand ratchet or impact wrench. To aid in the removal of the tube stub from the spear, back the spear off and then employ the Stub Tugger or Manual Tube Puller to successfully remove the tube.

Features & Benefits:

- New, innovative design means the best tool life possible at a competitive price.
- The best value spear on the market.
- Each spear is rated to withstand a minimum of 120,000 psi tensile strength to increase pulling capacity and tool life.
- Engineered design lowers the chance that the gripping end of the spear will break off in the tube, saving time, money and hassle.

Spares & Accessories:

- P8788 Spear Lubricant: Highly recommended for use on spear threads to greatly increase spear life.

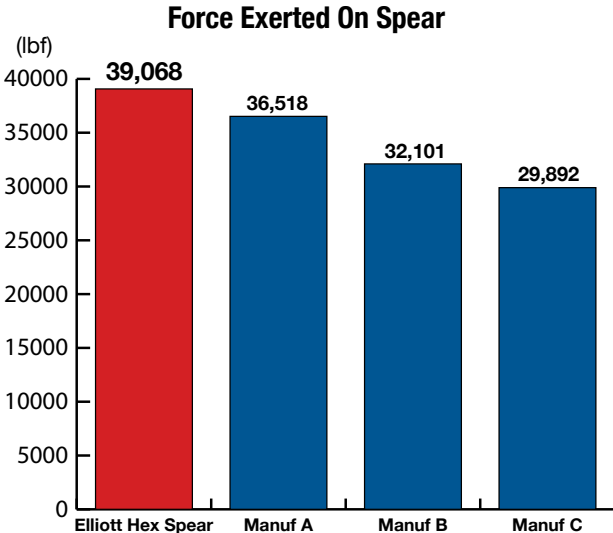

E-SERIES HEX SPEARS

E-SERIES HEX SPEARS

| Tube OD | BWG | Part # | "A" Ø | | Hex Size |
|--------------------|-------|----------|-------|------|-----------|
| | | | Inch | mm | |
| 3/8" (9.5mm) | 16-17 | E375-16 | 0.240 | 6.1 | 5/8" Flat |
| | 18-19 | E375-18 | 0.272 | 6.9 | |
| | 20-22 | E375-20 | 0.295 | 7.5 | |
| 1/2" (12.7mm) | 16-17 | E500-16 | 0.365 | 9.3 | 7/8" |
| | 18-19 | E500-18 | 0.397 | 10.1 | |
| | 20-22 | E500-20 | 0.427 | 10.9 | |
| 5/8" (15.8mm) | 12-13 | E625-12 | 0.402 | 10.2 | |
| | 14-15 | E625-14 | 0.454 | 11.5 | |
| | 16-17 | E625-16 | 0.489 | 12.4 | |
| | 18-19 | E625-18 | 0.521 | 13.2 | |
| | 20-22 | E625-20 | 0.545 | 13.8 | |
| 3/4" (19.1mm) | 8-9 | E750-8 | 0.410 | 10.4 | |
| | 10-11 | E750-10 | 0.470 | 11.9 | |
| | 12-13 | E750-12 | 0.520 | 13.2 | |
| | 14-15 | E750-14 | 0.579 | 14.7 | |
| | 16-17 | E750-16 | 0.614 | 15.6 | |
| | 18-19 | E750-18 | 0.646 | 16.4 | |
| 7/8" (22.2mm) | 20-22 | E750-20 | 0.670 | 17.0 | |
| | 12-13 | E875-12 | 0.652 | 16.6 | |
| | 14-15 | E875-14 | 0.699 | 17.8 | |
| | 16-17 | E875-16 | 0.740 | 18.8 | |
| | 18-19 | E875-18 | 0.760 | 19.3 | |
| 1" (25.4mm) | 20-22 | E875-20 | 0.800 | 20.3 | |
| | 8-9 | E1000-8 | 0.660 | 16.8 | |
| | 10-11 | E1000-10 | 0.720 | 18.3 | |
| | 12-13 | E1000-12 | 0.777 | 19.7 | |
| | 14-15 | E1000-14 | 0.829 | 21.1 | |
| | 16-17 | E1000-16 | 0.864 | 22.0 | |
| 1-1/4" (31.8mm) | 18-19 | E1000-18 | 0.896 | 22.8 | |
| | 20-22 | E1000-20 | 0.920 | 23.3 | |
| | 8-9 | E1250-8 | 0.900 | 22.9 | |
| | 10-11 | E1250-10 | 0.977 | 24.8 | |
| | 12-13 | E1250-12 | 1.027 | 26.1 | |
| 1-1/2" (38.1mm) | 14-15 | E1250-14 | 1.079 | 27.4 | |
| | 16-17 | E1250-16 | 1.115 | 28.3 | |
| | 18-19 | E1250-18 | 1.145 | 29.1 | |
| | 8-9 | E1500-8 | 1.165 | 29.6 | |
| | 10-11 | E1500-10 | 1.227 | 31.2 | |
| 1-3/4" (44.5mm) | 12-13 | E1500-12 | 1.277 | 31.9 | |
| | 14-15 | E1500-14 | 1.329 | 33.8 | |
| | 16-17 | E1500-16 | 1.365 | 34.7 | |
| | 10-11 | E1750-10 | 1.462 | 37.1 | |
| 2" (50.8mm) | 12-13 | E1750-12 | 1.512 | 38.4 | |
| | 14-15 | E1750-14 | 1.564 | 39.7 | |
| | 16-17 | E1750-16 | 1.600 | 40.6 | |
| | 7-9 | E2000-7 | 1.620 | 41.2 | |
| | 10-11 | E2000-10 | 1.710 | 43.4 | |
| 2-1/2" (63.5mm) | 12-13 | E2000-12 | 1.770 | 45.0 | |
| | 14-15 | E2000-14 | 1.820 | 46.2 | |
| | 16-17 | E2000-16 | 1.865 | 47.4 | |
| | 18-19 | E2000-18 | 1.897 | 48.2 | |
| 3" (76.2mm) | 7-9 | E2500-7 | 2.120 | 53.9 | |
| | 10-11 | E2500-10 | 2.220 | 56.4 | |
| | 12-13 | E2500-12 | 2.270 | 57.7 | |
| 3" | 14-15 | E2500-14 | 2.320 | 58.9 | |
| | 10-11 | E3000-10 | 2.722 | 69.1 | |
| | 12-13 | E3000-12 | 2.772 | 70.4 | |
| | 14-15 | E3000-14 | 2.820 | 71.6 | |



430G SERIES

Pneumatic Hammer

Tube Size

- 0.375" to 2.000" OD
- (9.5 to 50.8mm) OD



Elliott's 430G Pneumatic Hammer is the recommended driving tool for Elliott's Knockout Tools and Collapsing Tools to remove tube stubs in heat exchangers or beading tubes in firetube boilers.

Knockout Tools are used to punch the tubes out of the tube sheet while Collapsing Tools collapse tubes from one end of a heat exchanger and then the tube is pulled from the other end.

The 430G Pneumatic Hammer accepts Type No. 6 0.680" (17.3mm) diameter by 2-3/8" (60.3mm) long shanks.

Features & Benefits:

- Lightweight & compact design - easy to move in tight areas.
- Used also for tube collapsing and flaring - greater productivity.

Specifications:

- Piston Diameter & Stroke: 1-1/8" X 2" (28.6 X 50.8mm).
- Length (Overall): 14" (355.6mm).
- Blows per minute: 2,300.
- Net Weight: 17 lbs. (7 Kg.).
- Air Requirement: 30 CFM @ 90 PSI.
- Hose Diameter: 1/2" (12.7mm).

430G Pneumatic Hammer package includes:

- Hose Whip
- Filter-Lubricator
- Carrying Case

Spares & Accessories:

- 6070 Filter-Lubricator: Included with the 430G Pneumatic Hammer package.
- Knockout Tools
- Collapsing Tools



430G SERIES

Spares & Accessories

Knockout Tools



Elliott's Knockout Tools, also known as tube drifts, are used to punch the tubes out of a tube sheet with the 430G Pneumatic Hammer.

The Type No. 6 Shank 0.680 (17.3mm) diameter by 2-3/8" (60.3mm) long with retainer is the standard shank supplied with these tools. Other style shanks are available. Contact Customer Service for details.

| Tube OD | BWG | Part # | Tube OD | BWG | Part # |
|------------------|-----------|-----------|------------------|-----|------------|
| 1/2" (12.7mm) | 15 | 8496-29T6 | 3/4" (19.1mm) | 17 | 8496-76T6 |
| | 16 | 8496-30T6 | | 18 | 8496-77T6 |
| | 17 | 8496-31T6 | | 19 | 8496-78T6 |
| | 18 | 8496-32T6 | | 20 | 8496-79T6 |
| | 19 | 8496-33T6 | | 10 | 8496-87T6 |
| | 20 | 8496-34T6 | | 11 | 8496-88T6 |
| 5/8" (15.9mm) | 10 | 8496-45T6 | 7/8" (22.2mm) | 12 | 8496-89T6 |
| | 11 | 8496-46T6 | | 13 | 8496-90T6 |
| | 12 | 8496-47T6 | | 14 | 8496-91T6 |
| | 13 | 8496-48T6 | | 15 | 8496-92T6 |
| | 14 | 8496-49T6 | | 16 | 8496-93T6 |
| | 15 | 8496-50T6 | | 17 | 8496-94T6 |
| | 16 | 8496-51T6 | | 18 | 8496-95T6 |
| | 17 | 8496-52T6 | | 19 | 8496-96T6 |
| | 18 | 8496-53T6 | | 20 | 8496-97T6 |
| | 19 | 8496-54T6 | | 21 | 8496-98T6 |
| 20 | 8496-55T6 | 22 | 8496-99T6 | | |
| 3/4" (19.1mm) | 8 | 8496-67T6 | 1" (25.4mm) | 10 | 8496-102T6 |
| | 9 | 8496-68T6 | | 11 | 8496-103T6 |
| | 10 | 8496-69T6 | | 12 | 8496-104T6 |
| | 11 | 8496-70T6 | | 13 | 8496-105T6 |
| | 12 | 8496-71T6 | | 14 | 8496-106T6 |
| | 13 | 8496-72T6 | | 15 | 8496-107T6 |
| | 14 | 8496-73T6 | | 16 | 8496-108T6 |
| | 15 | 8496-74T6 | | 17 | 8496-109T6 |
| | 16 | 8496-75T6 | | 18 | 8496-110T6 |

Collapsing Tools



Elliott's Collapsing Tools are used to collapse one end of the tube; then the tube is pulled from the other end of the heat exchanger. Collapsing tools may either be used by hand or with the 430G Pneumatic Hammer.

The Collapsing Tool with the 430G Pneumatic Hammer can also be used as a tube ripper. Simply place the ripping edge of the chisel into one of the flutes of the tube pulling spear and press the trigger, then run the chisel down the spear's flute to the end. The tube can then be easily removed from the spear by hand.

The Type No. 6 Shank 0.680 (17.3mm) diameter by 2-3/8" (60.3mm) long with retainer is the standard shank supplied with these tools. Other style shanks are available. Contact Customer Service for details.

| Tube OD | Part # | Maximum Sheet |
|---------|-----------|---------------|
| 3/8" | 8637-6T6 | 1-3/4" |
| 1/2" | 8637-8T6 | 2-1/2" |
| 5/8" | 8637-10T6 | 2-1/2" |
| 3/4" | 8637-12T6 | 2-5/8" |
| 7/8" | 8637-14T6 | 2-3/4" |
| 1" | 8637-16T6 | 3" |
| 1-1/8" | 8637-18T6 | 3-1/4" |

| Tube OD | Part # | Maximum Sheet |
|---------|-----------|---------------|
| 1-1/4" | 8637-20T6 | 3-1/4" |
| 1-3/8" | 8637-22T6 | 3-1/4" |
| 1-1/2" | 8637-24T6 | 3-1/4" |
| 1-5/8" | 8637-26T6 | 3-3/8" |
| 1-3/4" | 8637-28T6 | 3-1/2" |
| 1-7/8" | 8637-30T6 | 4" |
| 2" | 8637-32T6 | 4-1/4" |



YOUR COMPLETE RE-TUBING TOOLKIT

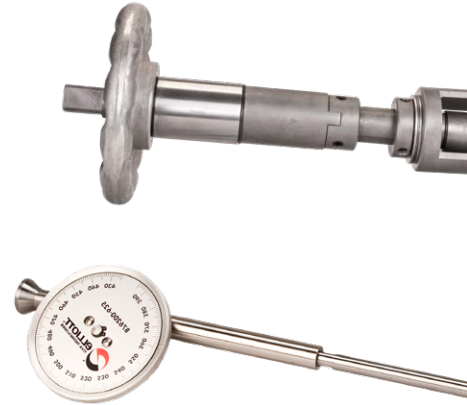

8 MUST-HAVE TOOLS FOR RETUBING

1. Tube Gauges:

Tube gauges are used to measure the inner diameter (ID) of the tube and tube sheet hole. This is important for determining the correct size of the replacement tubes and the right tooling for the job.

2. Tube Cutters:

Tube cutters are often the first step in tube removal. Depending on the style of cutter you can easily cut out a few tubes or saw the entire bundle.

3. Manual Tools:

Manual tools, such as pneumatic hammers and chisels may be used to knockout tubes or tube stubs from the tube sheet. These are especially common in more difficult applications such as a grooved tube sheet or severely corroded tubes. While powerful, the main disadvantage to knockout tools is that they can cause damage to the tube sheet.

4. Spear Type Tube Pullers:

Spear-type tube pullers are a hydraulic tube pulling system used to remove tubes and tube stubs from heat exchangers and boilers. These systems offer a large pulling capacity, making it easier to break expanded tube sheet joints.

5. Collet-Style Tube Pullers:

Collet-type tube pullers are designed to quickly remove tube stubs without causing damage to the tube sheet hole. This one step process grips, pulls, and releases the tube stub in a matter of seconds, making it a quicker alternative to spear pulling or knockout tools.

6. Grooving Tools:

Grooving tools are used to create grooves in tube sheet holes. This adds additional joint strength when tubes are expanded into the tube sheet.

7. End-Prep Tools:

End-prep tools are used to prepare the ends of the new tubes for installation. This is important for ensuring a proper expansion and preventing leaks.

8. Tube Expanders:

Tube expanders are used to install new tubes into the tube sheet. Whether it's a boiler or heat exchanger tool, an expander is used to create a tight, leak-free mechanical joint.

430D SERIES

Jumbo Tube Buster

Tube Size

- 0.625" to 2.500" OD
- (15.9 to 63.5mm) OD



Elliott's 430D Jumbo Tube Buster is the recommended driving tool for Elliott's Jumbo Knockout Tools to remove tube stubs in heat exchangers, firetube boilers, and watertube boilers.

Jumbo Knockout Tools are used to punch the tubes out of the tube sheet and are available in either 8" (203.0mm) or 16" (406.0mm) reach. The tools are piloted to prevent damage to the tube sheet.

The 430D Jumbo Tube Buster uses a number 15 shank. The tool features a barrel design that captures the compression piston and the inside trigger feature permits throttle control of the tool.

Features & Benefits:

- Lightweight & compact design - easy to move in tight areas.
- Uses retainers on tools - improved operator safety.
- Used also for tube collapsing, belling, and flaring - greater productivity.

Specifications:

- Piston Diameter & Stroke: 1-3/16" X 8" (30.2 X 203.2mm).
- Net Weight: 30 lbs. (13.6 Kg.).
- Air Requirement: 42 CFM @ 90 PSI.
- Hose Diameter: 1/2" (12.7mm) NPT.

430D Jumbo Tube Buster package includes:

- Hose Whip
- Filter-Lubricator
- Carrying Case

Spares & Accessories:

- 6070 Filter-Lubricator: Included with the 430D Jumbo Tube Buster package.
- Knockout Tools: Available with 8" (203.0mm) or 16" (406.0mm) reaches.



Elliott's Jumbo Knockout Tools, also known as tube drifts, are used to punch the tubes out of a tube sheet with the 430D Jumbo Tube Buster.

The 430D Jumbo Tube Buster uses shank number 15. The Jumbo Knockout Tools are available in reaches of both 8" (203.2mm) and 16" (406.4mm).



| 8" (203.2mm) Reach Jumbo Knockout Tools (Tube Drifts) | | | | | |
|---|--------------|--------------|--------------|--------------|--------------|
| Tube OD | Gauges 10-11 | Gauges 12-13 | Gauges 14-15 | Gauges 16-17 | Gauges 18-19 |
| 5/8" (15.9mm) | 8777-1010 | 8777-1012 | 8777-1014 | 8777-1016 | 8777-1018 |
| 3/4" (19.1mm) | 8777-1210 | 8777-1212 | 8777-1214 | 8777-1216 | 8777-1218 |
| 7/8" (22.2mm) | 8777-1410 | 8777-1412 | 8777-1414 | 8777-1416 | 8777-1418 |
| 1" (25.4mm) | 8777-1610 | 8777-1612 | 8777-1614 | 8777-1616 | 8777-1618 |
| 1-1/4" (31.8mm) | 8777-2010 | 8777-2012 | 8777-2014 | 8777-2016 | 8777-2018 |
| 1-1/2" (38.1mm) | 8777-2410 | 8777-2412 | 8777-2414 | 8777-2416 | 8777-2418 |
| 1-3/4" (44.5mm) | 8777-2810 | 8777-2812 | 8777-2814 | 8777-2816 | 8777-2818 |
| 2" (50.8mm) | 8777-3210 | 8777-3212 | 8777-3214 | 8777-3216 | 8777-3218 |
| 2-1/2" (63.5mm) | 8777-4010 | 8777-4012 | 8777-4014 | 8777-4016 | 8777-4018 |

| 16" (406.4mm) Reach Jumbo Knockout Tools (Tube Drifts) | | | | | |
|--|--------------|--------------|--------------|--------------|--------------|
| Tube OD | Gauges 10-11 | Gauges 12-13 | Gauges 14-15 | Gauges 16-17 | Gauges 18-19 |
| 5/8" (15.9mm) | 8777-1010-16 | 8777-1012-16 | 8777-1014-16 | 8777-1016-16 | 8777-1018-16 |
| 3/4" (19.1mm) | 8777-1210-16 | 8777-1212-16 | 8777-1214-16 | 8777-1216-16 | 8777-1218-16 |
| 7/8" (22.2mm) | 8777-1410-16 | 8777-1412-16 | 8777-1414-16 | 8777-1416-16 | 8777-1418-16 |
| 1" (25.4mm) | 8777-1610-16 | 8777-1612-16 | 8777-1614-16 | 8777-1616-16 | 8777-1618-16 |
| 1-1/4" (31.8mm) | 8777-2010-16 | 8777-2012-16 | 8777-2014-16 | 8777-2016-16 | 8777-2018-16 |
| 1-1/2" (38.1mm) | 8777-2410-16 | 8777-2412-16 | 8777-2414-16 | 8777-2416-16 | 8777-2418-16 |
| 1-3/4" (44.5mm) | 8777-2810-16 | 8777-2812-16 | 8777-2814-16 | 8777-2816-16 | 8777-2818-16 |
| 2" (50.8mm) | 8777-3210-16 | 8777-3212-16 | 8777-3214-16 | 8777-3216-16 | 8777-3218-16 |
| 2-1/2" (63.5mm) | 8777-4010-16 | 8777-4012-16 | 8777-4014-16 | 8777-4016-16 | 8777-4018-16 |

Note: Split Sleeve 430D1 is required for operating 1" (25.4mm) and larger Jumbo Knockout Tools.



SUPPORT



CONTENTS

| | |
|--|-----|
| Quality Assurance | 228 |
| “I Need It Yesterday” | 229 |
| Rental Capability | 230 |
| Tube Wall Conversion Table | 232 |
| Recommended Cutting Speed Specifications | 233 |

QUALITY ASSURANCE

Elliott Tool Technologies has always stood for quality tube tools. From engineering, manufacturing and quality control Elliott is committed to producing a product that you can be confident in using time after time.

Elliott's Quality

You can rely on Elliott to provide tools that are tougher than the job and are the best in the industry. To achieve this goal, we utilize continuous improvement, Six Sigma and 5-S. Elliott firmly believes the last thing you should have to worry about is the quality of your tools. However, if you require a more formal assurance of quality we do offer the following options.

Certificate of Compliance/Conformance

A Certificate of Compliance/Conformance will certify your tool is manufactured according to our engineer specifications. Some refer to a Certificate of Compliance and a Certificate of Conformance as two separate Certificates; Elliott considers them as one Certificate. Should you require a Certificate of Compliance/Conformance, there is no additional charge. In most cases, customer requests for a Certificate of Compliance/Conformance will not delay the delivery of your tools. Requests for Certificates of Compliance/Conformance must be made at the time of your order.

Materials Certificate

A Materials Certificate certifies the material used to manufacture the tools. The price of a Materials Certificate will vary based on the complexity of the tool. Requests for a Materials Certificate could change availability and delivery time of your tools depending on the complexity of the part. A complete quote for pricing and availability is available upon request. Requests for Materials Certificates must be made at the time of your order.

For more specific information, contact your Elliott sales representative.



I can go to our tube rolling equipment drawers and pull out serviceable rolling equipment that could easily be older than my 62 years!

Don Poush

Lean Manufacutring Engineer



Elliott Tool strives to be the industry’s leading supplier of Quality tube tools for an ‘I need it yesterday’ world.™ Here are the services you can count on.

Catalog Items

Many of the items shown in this catalog are in stock and available for same day shipment when we receive your order on business days before 5:00 PM US Eastern. Orders destined for export or requiring shipment via freight usually can be shipped the next day. If the catalog item is not available for immediate shipment in the quantities you need, we will rapidly explore all of these options:

- Partial shipment to get you started while Elliott manufactures the balance of your needs.
- Expediting your need through the manufacturing process.
- If your need is recurring, revising Elliott’s stock accordingly.

If after you have submitted an order to Elliott and later decide you need it sooner, Elliott will do everything possible to meet your needs. Your Elliott sales representative will investigate for free if the item(s):

- Are already available for complete shipment.
- Are available for partial shipment.
- If expediting through manufacturing according to your new need is possible.

If expediting is possible, a service fee of the lesser of \$250 or 25% of the extended amount of the line item(s) being expedited is applied. This service fee helps to defray Elliott’s additional costs related to manufacturing rescheduling, overtime labor, and expediting fees Elliott incurs with our suppliers.

Special Items

Elliott Tool welcomes the opportunity to meet your needs for tube tools not included in this catalog and has more than 100 years of development experience to back you up. Normal lead times are 30 business days after receipt of your approval of our design. If your need is more urgent Elliott can usually provide expediting for a service fee of the greater of \$250 or 25% of the extended amount of the line item(s) being expedited. This service fee helps to defray Elliott’s additional costs related to manufacturing rescheduling, overtime labor, and expediting fees Elliott incurs with our suppliers.

Should your need for a special item be ongoing then Elliott Tool will commit to understand and supply the items to you according to your forecast. Contact your Elliott Tool sales representative for more information.

RENTAL CAPABILITY

Look for the **“FOR RENT”** stamp at the bottom of the product page.



Many of the products in this catalog are available for rent to customers and sites located in the United States and Canada. There are many practical considerations prohibitively affecting rental commerce outside of the United States and Canada but such customers are invited to contact Elliott to discuss ways to overcome them.

Elliott offers daily, weekly, and monthly rental rates. Unless otherwise noted, all quotes are at the weekly rate. Rentals accrue daily, have a 1 week minimum rental period, and will be charged according to the daily, weekly or monthly rate for the rental period. The rental period begins when you receive the item and stops when you ship it back to Elliott.

Upon shipment Elliott will invoice for the first 7 days of rental, any consumable items, and outbound freight. Every 28 days of rent, Elliott will issue a progress bill based on the monthly rate for that item less the pre-paid amount for the first week. After the item is returned, a final bill for any outstanding rent will be invoiced. For rentals that are paid by credit card, a one-month deposit is required. At each progress bill, an additional month will be charged for the next rental period. Once the item is returned, the difference between the pre-charged amount and the actual rental will be credited back to the credit card on file.

Return all rental equipment to:

Elliott Tool Technologies, Ltd
Attn: Rental Department
1760 Tuttle Avenue
Dayton, OH 45403
United States

A Return Material Authorization (RMA) is not required.

If you choose to purchase a new item, Elliott will credit 50%* of the current rental charges for that item towards the purchase of the same item.

**The maximum credit you will receive towards the purchase of a new tool may not exceed 25% of the Retail List Price of that brand new tool.*

If you choose to purchase the rental item, Elliott will credit 50%** of the current rental charges towards the purchase of the used rental item.

***The maximum credit you will receive towards the purchase of a used tool may not exceed 25% of the Retail List Price. (Retail List Price of a rental tool is 15% less than the list price of that of the same tool in brand new condition).*

You must notify Elliott of your interest in doing so while the rental period is still open. Please note that some equipment is excluded from this offer.

Repairs of rental equipment due to reasons other than normal wear will be charged to the renter. Rental equipment not returned will be invoiced at Elliott's list price in addition to the rental charges. Consumable items that are returned will be credited in accordance with the customer returns terms and conditions.





TRAIN SMARTER. WORK SAFER. PERFORM BETTER.

BOOST **PRODUCTIVITY** AND OPERATOR CONFIDENCE WITH TRAINING **TAILORED TO YOUR TEAM.**

In today's market, efficiency and precision are everything. Elliott's on-site training programs bring expert instruction directly to your facility — helping teams improve performance, extend tool life, and ensure every operator is working safely and effectively.

Each session is customized to your equipment and application, combining classroom instruction with real-world demonstrations using your actual tools.

Key Topics Include:

- Heat Exchanger & Boiler Tube Installation & Retubing
- Tube Cleaning & Maintenance
- Tube Testing & Plugging
- Tube Tool Best Practices
- Overcoming Application Challenges

“ Elliott really **paid attention** to what I needed to accomplish on the job and helped me select the best cleaning option. Visiting Elliott's solution center allowed me to see several systems first hand, helping us choose a safer and more cost effective method. Their team was also able to provide **valuable on-site training** to make sure we got the best results out of our tooling.

Matt Sauls
Midwest Environmental
Services



Schedule an in-person training for your team today!

TUBE WALL CONVERSION TABLE

TUBE WALL CONVERSION TABLE

| B.W.G. | Wall Thickness | Outside Diameter Tubes | | | | | | | | | | | | | | | | | | | | | |
|--------|----------------|------------------------|-------|-------|-------|-------|-------|-------|--------|--------|--------|-------|--------|--------|--------|-------|--------|--------|--------|--------|--------|--------|-------|
| | | 1/4" | 3/8" | 1/2" | 5/8" | 3/4" | 7/8" | 1" | 1 1/4" | 1 1/2" | 1 3/4" | 2" | 2 1/4" | 2 1/2" | 2 3/4" | 3" | 3 1/4" | 3 1/2" | 3 3/4" | 4" | 4 1/4" | 4 1/2" | |
| | | 6.35 | 9.52 | 12.70 | 15.87 | 19.05 | 22.22 | 25.40 | 31.75 | 38.10 | 44.45 | 50.80 | 57.15 | 63.50 | 69.85 | 76.20 | 82.55 | 88.90 | 95.25 | 101.60 | 107.95 | 114.30 | |
| 00 | inch 0.380 | | | | | | 0.115 | 0.240 | 0.490 | 0.740 | 0.990 | 1.240 | 1.490 | 1.740 | 1.990 | 2.240 | 2.490 | 2.740 | 2.990 | 3.240 | 3.490 | 3.740 | |
| | mm 9.65 | | | | | | 2.92 | 6.10 | 12.45 | 18.80 | 25.15 | 31.50 | 37.85 | 44.20 | 50.55 | 56.90 | 63.25 | 69.60 | 75.95 | 82.30 | 88.65 | 95.00 | |
| 0 | inch 0.340 | | | | | | 0.070 | 0.195 | 0.320 | 0.570 | 0.820 | 1.070 | 1.320 | 1.570 | 1.820 | 2.070 | 2.320 | 2.570 | 2.820 | 3.070 | 3.320 | 3.570 | 3.820 |
| | mm 8.64 | | | | | | 1.78 | 4.95 | 8.13 | 14.48 | 20.83 | 27.18 | 33.53 | 39.88 | 46.23 | 52.58 | 58.93 | 65.28 | 71.63 | 77.98 | 84.33 | 90.68 | 97.03 |
| 1 | inch 0.300 | | | | 0.025 | 0.150 | 0.275 | 0.400 | 0.650 | 0.900 | 1.150 | 1.400 | 1.650 | 1.900 | 2.150 | 2.400 | 2.650 | 2.900 | 3.150 | 3.400 | 3.650 | 3.900 | |
| | mm 7.62 | | | | 0.64 | 3.81 | 6.99 | 10.16 | 16.51 | 22.86 | 29.21 | 35.56 | 41.91 | 48.26 | 54.61 | 60.96 | 67.31 | 73.66 | 80.01 | 86.36 | 92.71 | 99.06 | |
| 2 | inch 0.284 | | | | 0.057 | 0.182 | 0.307 | 0.432 | 0.682 | 0.932 | 1.182 | 1.432 | 1.682 | 1.932 | 2.182 | 2.432 | 2.682 | 2.932 | 3.182 | 3.432 | 3.682 | 3.932 | |
| | mm 7.21 | | | | 1.45 | 4.62 | 7.80 | 10.97 | 17.32 | 23.67 | 30.02 | 36.37 | 42.72 | 49.07 | 55.42 | 61.77 | 68.12 | 74.47 | 80.82 | 87.17 | 93.52 | 99.87 | |
| 3 | inch 0.259 | | | | 0.107 | 0.232 | 0.357 | 0.482 | 0.732 | 0.982 | 1.232 | 1.482 | 1.732 | 1.982 | 2.232 | 2.482 | 2.732 | 2.982 | 3.232 | 3.482 | 3.732 | 3.982 | |
| | mm 6.58 | | | | 2.72 | 5.89 | 9.07 | 12.24 | 18.59 | 24.94 | 31.29 | 37.64 | 43.99 | 50.34 | 56.69 | 63.04 | 69.39 | 75.74 | 82.09 | 88.44 | 94.79 | 101.14 | |
| 4 | inch 0.238 | | | 0.024 | 0.149 | 0.274 | 0.399 | 0.524 | 0.774 | 1.024 | 1.274 | 1.524 | 1.774 | 2.024 | 2.274 | 2.524 | 2.774 | 3.024 | 3.274 | 3.524 | 3.774 | 4.024 | |
| | mm 6.05 | | | 0.61 | 3.78 | 6.96 | 10.13 | 13.31 | 19.66 | 26.01 | 32.36 | 38.71 | 45.06 | 51.41 | 57.76 | 64.11 | 70.46 | 76.81 | 83.16 | 89.51 | 95.86 | 102.21 | |
| 5 | inch 0.220 | | | 0.060 | 0.185 | 0.310 | 0.435 | 0.560 | 0.810 | 1.060 | 1.310 | 1.560 | 1.810 | 2.060 | 2.310 | 2.560 | 2.810 | 3.060 | 3.310 | 3.560 | 3.810 | 4.060 | |
| | mm 5.59 | | | 1.52 | 4.70 | 7.87 | 11.05 | 14.22 | 20.57 | 26.92 | 33.27 | 39.62 | 45.97 | 52.32 | 58.67 | 65.02 | 71.37 | 77.72 | 84.07 | 90.42 | 96.77 | 103.12 | |
| 6 | inch 0.203 | | | 0.094 | 0.219 | 0.344 | 0.469 | 0.594 | 0.844 | 1.094 | 1.344 | 1.594 | 1.844 | 2.094 | 2.344 | 2.594 | 2.844 | 3.094 | 3.344 | 3.594 | 3.844 | 4.094 | |
| | mm 5.16 | | | 2.39 | 5.56 | 8.74 | 11.91 | 15.09 | 21.44 | 27.79 | 34.14 | 40.49 | 46.84 | 53.19 | 59.54 | 65.89 | 72.24 | 78.59 | 84.94 | 91.29 | 97.64 | 103.99 | |
| 7 | inch 0.180 | | | 0.140 | 0.265 | 0.390 | 0.515 | 0.640 | 0.890 | 1.140 | 1.390 | 1.640 | 1.890 | 2.140 | 2.390 | 2.640 | 2.890 | 3.140 | 3.390 | 3.640 | 3.890 | 4.140 | |
| | mm 4.57 | | | 3.56 | 6.73 | 9.91 | 13.08 | 16.26 | 22.61 | 28.96 | 35.31 | 41.66 | 48.01 | 54.36 | 60.71 | 67.06 | 73.41 | 79.76 | 86.11 | 92.46 | 98.81 | 105.16 | |
| 8 | inch 0.165 | | 0.045 | 0.170 | 0.295 | 0.420 | 0.545 | 0.670 | 0.920 | 1.170 | 1.420 | 1.670 | 1.920 | 2.170 | 2.420 | 2.670 | 2.920 | 3.170 | 3.420 | 3.670 | 3.920 | 4.170 | |
| | mm 4.19 | | 1.14 | 4.32 | 7.49 | 10.67 | 13.84 | 17.02 | 23.37 | 29.72 | 36.07 | 42.42 | 48.77 | 55.12 | 61.47 | 67.82 | 74.17 | 80.52 | 86.87 | 93.22 | 99.57 | 105.92 | |
| 9 | inch 0.148 | | 0.079 | 0.204 | 0.329 | 0.454 | 0.579 | 0.704 | 0.954 | 1.204 | 1.454 | 1.704 | 1.954 | 2.204 | 2.454 | 2.704 | 2.954 | 3.204 | 3.454 | 3.704 | 3.954 | 4.204 | |
| | mm 3.76 | | 2.01 | 5.18 | 8.36 | 11.53 | 14.71 | 17.88 | 24.23 | 30.58 | 36.93 | 43.28 | 49.63 | 55.98 | 62.33 | 68.68 | 75.03 | 81.38 | 87.73 | 94.08 | 100.43 | 106.78 | |
| 10 | inch 0.134 | | 0.107 | 0.232 | 0.357 | 0.482 | 0.607 | 0.732 | 0.982 | 1.232 | 1.482 | 1.732 | 1.982 | 2.232 | 2.482 | 2.732 | 2.982 | 3.232 | 3.482 | 3.732 | 3.982 | 4.232 | |
| | mm 3.40 | | 2.72 | 5.89 | 9.07 | 12.24 | 15.42 | 18.59 | 24.94 | 31.29 | 37.64 | 43.99 | 50.34 | 56.69 | 63.04 | 69.39 | 75.74 | 82.09 | 88.44 | 94.79 | 101.14 | 107.49 | |
| 11 | inch 0.120 | | 0.135 | 0.260 | 0.385 | 0.510 | 0.635 | 0.760 | 1.010 | 1.260 | 1.510 | 1.760 | 2.010 | 2.260 | 2.510 | 2.760 | 3.010 | 3.260 | 3.510 | 3.760 | 4.010 | 4.260 | |
| | mm 3.05 | | 3.43 | 6.60 | 9.78 | 12.95 | 16.13 | 19.30 | 25.65 | 32.00 | 38.35 | 44.70 | 51.05 | 57.40 | 63.75 | 70.10 | 76.45 | 82.80 | 89.15 | 95.50 | 101.85 | 108.20 | |
| 12 | inch 0.109 | 0.032 | 0.157 | 0.282 | 0.407 | 0.532 | 0.657 | 0.782 | 1.032 | 1.282 | 1.532 | 1.782 | 2.032 | 2.282 | 2.532 | 2.782 | 3.032 | 3.282 | 3.532 | 3.782 | 4.032 | 4.282 | |
| | mm 2.77 | 0.81 | 3.99 | 7.16 | 10.34 | 13.51 | 16.69 | 19.86 | 26.21 | 32.56 | 38.91 | 45.26 | 51.61 | 57.96 | 64.31 | 70.66 | 77.01 | 83.36 | 89.71 | 96.06 | 102.41 | 108.76 | |
| 13 | inch 0.095 | 0.060 | 0.185 | 0.310 | 0.435 | 0.560 | 0.685 | 0.810 | 1.060 | 1.310 | 1.560 | 1.810 | 2.060 | 2.310 | 2.560 | 2.810 | 3.060 | 3.310 | 3.560 | 3.810 | 4.060 | 4.310 | |
| | mm 2.41 | 1.52 | 4.70 | 7.87 | 11.05 | 14.22 | 17.40 | 20.57 | 26.92 | 33.27 | 39.62 | 45.97 | 52.32 | 58.67 | 65.02 | 71.37 | 77.72 | 84.07 | 90.42 | 96.77 | 103.12 | 109.47 | |
| 14 | inch 0.083 | 0.084 | 0.209 | 0.334 | 0.459 | 0.584 | 0.709 | 0.834 | 1.084 | 1.334 | 1.584 | 1.834 | 2.084 | 2.334 | 2.584 | 2.834 | 3.084 | 3.334 | 3.584 | 3.834 | 4.084 | 4.334 | |
| | mm 2.11 | 2.13 | 5.31 | 8.48 | 11.66 | 14.83 | 18.01 | 21.18 | 27.53 | 33.88 | 40.23 | 46.58 | 52.93 | 59.28 | 65.63 | 71.98 | 78.33 | 84.68 | 91.03 | 97.38 | 103.73 | 110.08 | |
| 15 | inch 0.072 | 0.106 | 0.231 | 0.356 | 0.481 | 0.606 | 0.731 | 0.856 | 1.106 | 1.356 | 1.606 | 1.856 | 2.106 | 2.356 | 2.606 | 2.856 | 3.106 | 3.356 | 3.606 | 3.856 | 4.106 | 4.356 | |
| | mm 1.83 | 2.69 | 5.87 | 9.04 | 12.22 | 15.39 | 18.57 | 21.74 | 28.09 | 34.44 | 40.79 | 47.14 | 53.49 | 59.84 | 66.19 | 72.54 | 78.89 | 85.24 | 91.59 | 97.94 | 104.29 | 110.64 | |
| 16 | inch 0.065 | 0.120 | 0.245 | 0.370 | 0.495 | 0.620 | 0.745 | 0.870 | 1.120 | 1.370 | 1.620 | 1.870 | 2.120 | 2.370 | 2.620 | 2.870 | 3.120 | 3.370 | 3.620 | 3.870 | 4.120 | 4.370 | |
| | mm 1.65 | 3.05 | 6.22 | 9.40 | 12.57 | 15.75 | 18.92 | 22.10 | 28.45 | 34.80 | 41.15 | 47.50 | 53.85 | 60.20 | 66.55 | 72.90 | 79.25 | 85.60 | 91.95 | 98.30 | 104.65 | 111.00 | |
| 17 | inch 0.058 | 0.134 | 0.259 | 0.384 | 0.509 | 0.634 | 0.759 | 0.884 | 1.134 | 1.384 | 1.634 | 1.884 | 2.134 | 2.384 | 2.634 | 2.884 | 3.134 | 3.384 | 3.634 | 3.884 | 4.134 | 4.384 | |
| | mm 1.47 | 3.40 | 6.58 | 9.75 | 12.93 | 16.10 | 19.28 | 22.45 | 28.80 | 35.15 | 41.50 | 47.85 | 54.20 | 60.55 | 66.90 | 73.25 | 79.60 | 85.95 | 92.30 | 98.65 | 105.00 | 111.35 | |
| 18 | inch 0.049 | 0.152 | 0.277 | 0.402 | 0.527 | 0.652 | 0.777 | 0.902 | 1.152 | 1.402 | 1.652 | 1.902 | 2.152 | 2.402 | 2.652 | 2.902 | 3.152 | 3.402 | 3.652 | 3.902 | 4.152 | 4.402 | |
| | mm 1.24 | 3.86 | 7.04 | 10.21 | 13.39 | 16.56 | 19.74 | 22.91 | 29.26 | 35.61 | 41.96 | 48.31 | 54.66 | 61.01 | 67.36 | 73.71 | 80.06 | 86.41 | 92.76 | 99.11 | 105.46 | 111.81 | |
| 19 | inch 0.042 | 0.166 | 0.291 | 0.416 | 0.541 | 0.666 | 0.791 | 0.916 | 1.166 | 1.416 | 1.666 | 1.916 | | | | | | | | | | | |
| | mm 1.07 | 4.22 | 7.39 | 10.57 | 13.74 | 16.92 | 20.09 | 23.27 | 29.62 | 35.97 | 42.32 | 48.67 | | | | | | | | | | | |
| 20 | inch 0.035 | 0.180 | 0.305 | 0.430 | 0.555 | 0.680 | 0.805 | 0.930 | 1.180 | 1.430 | 1.680 | 1.930 | | | | | | | | | | | |
| | mm 0.89 | 4.57 | 7.75 | 10.92 | 14.10 | 17.27 | 20.45 | 23.62 | 29.97 | 36.32 | 42.67 | 49.02 | | | | | | | | | | | |
| 21 | inch 0.032 | 0.186 | 0.311 | 0.436 | 0.561 | 0.686 | 0.811 | 0.936 | 1.186 | 1.436 | 1.686 | 1.936 | | | | | | | | | | | |
| | mm 0.81 | 4.72 | 7.90 | 11.07 | 14.25 | 17.42 | 20.60 | 23.77 | 30.12 | 36.47 | 42.82 | 49.15 | | | | | | | | | | | |
| 22 | inch 0.028 | 0.194 | 0.319 | 0.444 | 0.569 | 0.694 | 0.819 | 0.944 | 1.194 | 1.444 | 1.694 | 1.944 | | | | | | | | | | | |
| | mm 0.71 | 4.93 | 8.10 | 11.28 | 14.45 | 17.63 | 20.80 | 23.98 | 30.33 | 36.68 | 43.03 | 49.38 | | | | | | | | | | | |
| 23 | inch 0.025 | 0.200 | 0.325 | 0.450 | 0.575 | 0.700 | 0.825 | 0.950 | 1.200 | 1.450 | 1.700 | 1.950 | | | | | | | | | | | |
| | mm 0.64 | 5.08 | 8.26 | 11.43 | 14.61 | 17.78 | 20.96 | 24.13 | 30.48 | 36.83 | 43.18 | 49.53 | | | | | | | | | | | |
| 24 | inch 0.022 | 0.206 | 0.331 | 0.456 | 0.581 | 0.706 | 0.831 | 0.956 | 1.206 | 1.456 | 1.706 | 1.956 | | | | | | | | | | | |
| | mm 0.56 | 5.23 | 8.41 | 11.58 | 14.76 | 17.93 | 21.11 | 24.28 | 30.63 | 36.98 | 43.33 | 49.68 | | | | | | | | | | | |

*Above table does not allow for tube mill tolerance.

Table to Determine Pipe Size and Schedule Number

| Nominal Pipe Size (in.) | OD (in.) | Schedule Number for Pipe Sizes Wall Thickness / Inside Diameter (Inches) | | | | | | | | | | | | | | | | | | | | |
|-------------------------|----------|--|------|------|------|-----|----|-----|----|--|----|--|--|--|--|--|--|--|--|--|--|--|
| | | 40 | ID | 80 | ID | 120 | ID | 160 | ID | | ID | | | | | | | | | | | |
| 1/8 | .405 | .068 | .269 | .095 | .215 | | | | | | | | | | | | | | | | | |
| 1/4 | .540 | .088 | .364 | .119 | .302 | | | | | | | | | | | | | | | | | |
| 3/8 | .675 | .091 | .493 | .126 | .423 | | | | </ | | | | | | | | | | | | | |

RECOMMENDED CUTTING SPEED SPECIFICATIONS

Revolutions Per Minute

To obtain maximum cutting performance and cutter blade life, refer to the table below for the recommended cutting RPM. A slower RPM is recommended when the optimum cannot be obtained to maximize cutter blade life.

| Tube OD | Inconel 10 SFM | Hastelloy 20 SFM | 300 Series Stainless Steel 30 SFM | Monel 40 SFM | 400 Series Stainless Steel 50 SFM | Titanium 60 SFM | Carbon Steel 80 SFM | Copper 90 SFM | Copper Nickel 100 SFM | Red Brass 200 SFM | Admiralty Brass 225 SFM | Aluminum 250 SFM |
|---------------------|-------------------|---------------------|--|-----------------|--|--------------------|---------------------------|------------------|-----------------------------|----------------------|-------------------------------|---------------------|
| 1/4" (6.35mm) | 153 | 306 | 458 | 611 | 764 | 917 | 1222 | 1376 | 1528 | 3056 | 3438 | 3818 |
| 5/16" (7.94mm) | 122 | 244 | 367 | 489 | 611 | 733 | 978 | 1100 | 1222 | 2445 | 2750 | 3055 |
| 3/8" (9.53mm) | 102 | 204 | 306 | 408 | 509 | 611 | 815 | 916 | 1018 | 2037 | 2292 | 2545 |
| 7/16" (11.11mm) | 87 | 175 | 262 | 349 | 437 | 524 | 699 | 786 | 874 | 1746 | 1964 | 2182 |
| 1/2" (12.7mm) | 76 | 153 | 229 | 306 | 382 | 459 | 611 | 688 | 764 | 1528 | 1719 | 1909 |
| 9/16" (14.30mm) | 68 | 137 | 204 | 272 | 340 | 407 | 543 | 611 | 679 | 1358 | 1528 | 1697 |
| 5/8" (15.88mm) | 61 | 122 | 184 | 245 | 306 | 367 | 489 | 552 | 612 | 1222 | 1375 | 1527 |
| 11/16" (17.46mm) | 55 | 112 | 167 | 222 | 278 | 333 | 444 | 500 | 555 | 1111 | 1250 | 1388 |
| 3/4" (19.05mm) | 51 | 102 | 153 | 203 | 254 | 306 | 408 | 458 | 508 | 1019 | 1146 | 1273 |
| 13/16" (20.64mm) | 47 | 95 | 142 | 190 | 237 | 284 | 379 | 427 | 474 | 940 | 1058 | 1175 |
| 7/8" (22.23mm) | 44 | 87 | 131 | 175 | 219 | 262 | 349 | 392 | 438 | 873 | 982 | 1091 |
| 1" (25.40mm) | 38 | 76 | 115 | 153 | 191 | 229 | 306 | 344 | 382 | 764 | 859 | 955 |
| 1-1/8" (28.58mm) | 34 | 68 | 102 | 136 | 170 | 204 | 272 | 306 | 340 | 679 | 764 | 848 |
| 1-1/4" (31.75mm) | 31 | 61 | 92 | 123 | 153 | 183 | 245 | 274 | 306 | 611 | 688 | 764 |
| 1-3/8" (34.93mm) | 28 | 56 | 83 | 111 | 139 | 167 | 222 | 250 | 278 | 556 | 625 | 694 |
| 1-1/2" (38.10mm) | 25 | 51 | 76 | 102 | 127 | 153 | 204 | 230 | 254 | 509 | 573 | 636 |
| 1-3/4" (44.45mm) | 22 | 44 | 66 | 88 | 109 | 131 | 175 | 196 | 218 | 437 | 491 | 545 |
| 2" (50.80mm) | 19 | 38 | 57 | 76 | 96 | 115 | 153 | 172 | 191 | 382 | 430 | 477 |
| 2-1/2" (63.50mm) | 15 | 31 | 46 | 61 | 76 | 92 | 122 | 137 | 153 | 305 | 344 | 382 |
| 3" (76.20mm) | 13 | 25 | 38 | 51 | 64 | 76 | 102 | 115 | 127 | 255 | 286 | 318 |
| 4" (101.6mm) | 10 | 19 | 29 | 38 | 48 | 57 | 76 | 86 | 95 | 191 | 215 | 239 |





AUSTIN

BEAUMONT

HOUSTON

PORT ARTHUR

TEXAS CITY ★

YOUR GULF COAST PARTNER FOR FAST, LOCAL SUPPORT

Elliott's Texas location provides local expertise, quick response times, and hands-on support for customers throughout the Gulf Coast. Whether you need application guidance, tooling recommendations, or urgent service, our dedicated team is here to help keep your operations running efficiently.

WHAT OUR TEXAS TEAM OFFERS:

Local Application Support

Get guidance on tube installation, rolling, pulling, cleaning, and testing from technicians who understand the challenges of refinery, petrochemical, and power-generation environments.

Faster Response Times

Regional support means quicker turnaround on quotes, orders, and service needs.

On-Site Training & Demonstrations

Hands-on training tailored to your equipment, delivered at your facility.

Tooling Recommendations for Complex Applications

From tight access areas to heavy-wall tubes, our team helps you identify the most effective and cost-efficient solution.



Contact our Gulf Coast team for local support today.

ELLIOTT'S NEW GT SERIES GROOVING TOOL

CUTTING EDGE DESIGN & PERFORMANCE

Elliott's newly redesigned GT Series Grooving & Serrating Tools are engineered for optimal cutting performance and tool life. Designed for use in both manual and machining applications, allowing for greater customer flexibility.

READ MORE ON PAGE 13



CONTACT US

1760 Tuttle Avenue Dayton,
OH 45403 United States

+1 (800) 332 0447

elliott-tool.com

REQUEST A QUOTE



Scan to request a quote or go to
www.elliott-tool.com/contact-us/